

**BLACK  
BOX**

energy & life.

**LIGHTING**  
CATALOGUE

— Everything for professional lighting

2021

REXEL



**AVENIDA LENS**  
(page 256)

# BLACK BOX

energy & life.

## Proudly presenting Black Box

We present a completely new way of designing the lighting for construction projects. A new way of controlling the designing, construction and building. How to take energy savings to the next level without compromising the end result. Black Box is filled with the most advantaged lighting products and digital design and control services. It combines the most modern design service with the best-suited luminaires.

The concept was launched in 2019 and for the past two years our professional lighting designers have done a great job by finding many solutions for all kind of projects all over Finland. In addition to our design service, we wanted to offer our customers an even better possibility for multiple lighting solutions so now it is time to introduce you to a new range of Black Box luminaires.

Everything for professional lighting. In cooperation with our main lighting suppliers, we offer you a wide range of products designed by professionals for professionals.

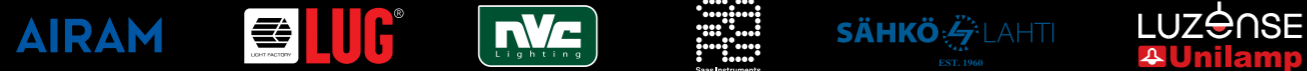

All Black Box products are covered by 5 year warranty

## What is Black Box?

Black Box is a comprehensive lighting design and procurement service for you who design, manage and build. We make the lighting and digital models. You get the lighting products and digital lighting design as a full service.



## Contractors and designers – concrete designing

We make the 3D model of your customer's building and the lighting for the space for you. Our modelling uses modern laser scanning. In our model, the lighting, light placement and final look are easy to see and review with the customer. This ensures that the end result fulfils the customer's wishes perfectly.

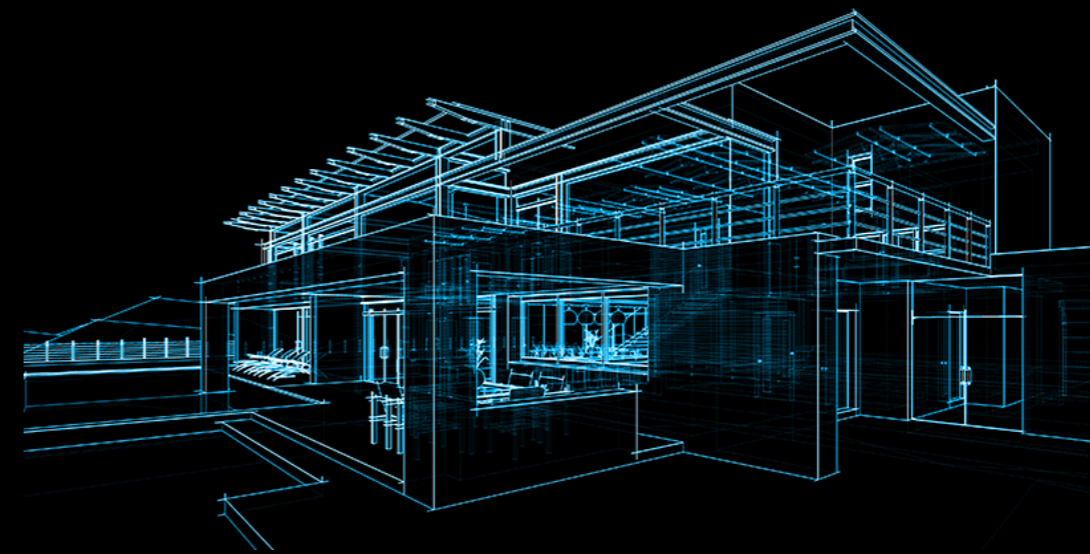

## Property owners and users – life cycle management

We make models compatible with designing software and a detailed lighting investment plan that serves throughout the property's life cycle. The property's overall lighting can be controlled effortlessly and the costs can be anticipated.

### The designing service provides you with things such as:

- Energy savings calculations
- 3D model images of sales and visuals based on the floor plan
- Laser scan of the space, if there is no floor plan
- "It's all in black and white", meaning that the plan follows the standards
- Illustrative dot images for further development
- The 3D modelling can be made as a data model in which the placements and heights of the lights are calculated with accuracy of less than 1cm

## BLACK BOX LUMINAIRE – contact details



**Fredrik Aminoff**  
 ✉ fredrik.aminoff@rexel.fi  
 ☎ +358 (0)50 016 1111



**Jyri Ojala**  
 ✉ jyri.ojala@rexel.fi  
 ☎ +358 (0)400 674 367

## BLACK BOX DESIGN TEAM – contact details



**Arto Kohtamäki**  
 arto.kohtamaki@rexel.fi  
 +358 (0)50 5093 513



**Timo Mattila**  
 timo.mattila@rexel.fi  
 +358 (0)400 821 719



**Lauri Vilkkilä**  
 lauri.vilkkila@rexel.fi  
 +358 (0)50 509 3565

## TABLE OF CONTENTS

### **Indoor luminaires**

|                                     |     |
|-------------------------------------|-----|
| Downlights.....                     | 12  |
| Downlight spots.....                | 26  |
| Downlight panels.....               | 42  |
| Module luminaires.....              | 46  |
| Office luminaires.....              | 58  |
| Market luminaires.....              | 74  |
| Spotlights.....                     | 78  |
| Plafonds.....                       | 86  |
| Workpoint luminaires.....           | 90  |
| LED-strips and profiles.....        | 96  |
| Fibres.....                         | 104 |
| Clean room lighting.....            | 106 |
| UV luminaires.....                  | 108 |
| Architectural luminaires.....       | 120 |
| Exit- and emergency luminaires..... | 130 |

### **Industrial luminaires**

|                                   |     |
|-----------------------------------|-----|
| Industrial luminaires.....        | 134 |
| Sealed industrial luminaires..... | 142 |
| Highbay luminaires.....           | 156 |

### **Outdoor luminaires**

|  |     |
|--|-----|
| Outdoor wall & ceiling luminaires..... | 174 |
| Floodlights.....                       | 242 |
| Outdoor spots.....                     | 250 |
| Park luminaires.....                   | 254 |
| Bollards.....                          | 280 |
| Street lighting.....                   | 292 |

**TULSA**  
(page 46)

# PORTFOLIO































Page guide











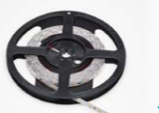

















**BLACK  
BOX**  
energy & life.

# PORTFOLIO

Page guide

**BLACK  
BOX**  
energy & life.

|   |   |   |   |   |
|---|---|---|---|---|
| <b>Lugstar</b><br><br>DOWNLIGHTS 12              | <b>Into R55</b><br><br>DOWNLIGHTS 14                 | <b>Into R100</b><br><br>DOWNLIGHTS 16            | <b>Into R160</b><br><br>DOWNLIGHTS 18             | <b>Into S</b><br><br>DOWNLIGHTS 22                     |
| <b>Stylosoft</b><br><br>DOWNLIGHTS 24            | <b>Tilt &amp; Tilt Eco</b><br><br>DOWNLIGHT SPOTS 26 | <b>Half</b><br><br>DOWNLIGHT SPOTS 28            | <b>Hidden</b><br><br>DOWNLIGHT SPOTS 32           | <b>Burbank</b><br><br>DOWNLIGHT SPOTS 34               |
| <b>Lugstar Spot</b><br><br>DOWNLIGHT SPOTS 38   | <b>Lightbox</b><br><br>DOWNLIGHT SPOTS 40           | <b>Harsted</b><br><br>DOWNLIGHT PANELS 42       | <b>Tulsa</b><br><br>MODULE LUMINAIRES 46         | <b>Fargo</b><br><br>MODULE LUMINAIRES 48              |
| <b>Office</b><br><br>MODULE LUMINAIRES 52      | <b>Soft Basic Led</b><br><br>OFFICE LUMINAIRES 54  | <b>Office flow</b><br><br>OFFICE LUMINAIRES 58 | <b>Volica 2.0</b><br><br>OFFICE LUMINAIRES 62   | <b>Volica 2.0 System</b><br><br>OFFICE LUMINAIRES 64 |
| <b>IQ Line Led</b><br><br>OFFICE LUMINAIRES 68 | <b>TLON 2.0</b><br><br>OFFICE LUMINAIRES 72        | <b>BB 7080</b><br><br>MARKET LUMINAIRES 74     | <b>Calibro</b><br><br>SPOTLIGHTS 78             | <b>Sonic ARM</b><br><br>SPOTLIGHTS 80                |
| <b>Sleeper</b><br><br>SPOTLIGHTS 84            | <b>Plafond</b><br><br>PLAFONDS 86                  | <b>Rockford</b><br><br>PLAFONDS 88             | <b>Workpoint</b><br><br>WORKPOINT LUMINAIRES 90 | <b>Nice Eco</b><br><br>WORKPOINT LUMINAIRES 92       |

|  |   |   |  |   |
|--|---|---|--|---|
| <b>Strip</b><br><br>LED-STRIPS AND PROFILES 96                  | <b>Ultrastrip</b><br><br>LED-STRIPS AND PROFILES 98                | <b>Powerstrip</b><br><br>LED-STRIPS AND PROFILES 100       | <b>Fibre</b><br><br>FIBRES 104                                  | <b>Medica</b><br><br>CLEAN ROOM LIGHTING 106               |
| <b>Purelight direct</b><br><br>UV LUMINAIRES 108                | <b>Purelight direct opti</b><br><br>UV LUMINAIRES 110              | <b>Purelight flow</b><br><br>UV LUMINAIRES 114             | <b>Purelight hybrid</b><br><br>UV LUMINAIRES 116                | <b>Archeo</b><br><br>ARCHITECTURAL LUMINAIRES 120          |
| <b>Balled downlight</b><br><br>ARCHITECTURAL LUMINAIRES 122    | <b>Balled Pendulum</b><br><br>ARCHITECTURAL LUMINAIRES 124        | <b>Noise</b><br><br>ARCHITECTURAL LUMINAIRES 128          | <b>Arlington PRO</b><br><br>EXIT- AND EMERGENCY LUMINAIRES 130 | <b>Nebraska</b><br><br>EXIT- AND EMERGENCY LUMINAIRES 132 |
| <b>Universal</b><br><br>INDUSTRIAL LUMINAIRES 134             | <b>Cornell</b><br><br>INDUSTRIAL LUMINAIRES 138                  | <b>Greenland</b><br><br>SEALED INDUSTRIAL LUMINAIRES 142 | <b>Cleveland</b><br><br>SEALED INDUSTRIAL LUMINAIRES 144      | <b>BB 8090</b><br><br>SEALED INDUSTRIAL LUMINAIRES 148   |
| <b>Atlantyk Basic</b><br><br>SEALED INDUSTRIAL LUMINAIRES 150 | <b>Atlantyk Chemical</b><br><br>SEALED INDUSTRIAL LUMINAIRES 152 | <b>Cruiser 2 Led</b><br><br>HIGHBAY LUMINAIRES 156       | <b>Cruiser 2 Plus Led</b><br><br>HIGHBAY LUMINAIRES 158       | <b>Cruiser Arena Led</b><br><br>HIGHBAY LUMINAIRES 162   |
| <b>Triton</b><br><br>HIGHBAY LUMINAIRES 166                   | <b>Triton Plus</b><br><br>HIGHBAY LUMINAIRES 168                 | <b>Highbay</b><br><br>HIGHBAY LUMINAIRES 170             |  |   |

# PORTFOLIO































Page guide























**BLACK BOX**  
energy & life.

# PORTFOLIO

Page guide

**BLACK BOX**  
energy & life.

|  |  |  |  |  |
|--|--|--|--|--|
| <b>Box &amp; Big Box</b><br><br>OUTDOOR WALL & CEILING LUMINAIRES 174 | <b>Arc</b><br><br>OUTDOOR WALL & CEILING LUMINAIRES 176             | <b>Kon</b><br><br>OUTDOOR WALL & CEILING LUMINAIRES 178           | <b>Edge</b><br><br>OUTDOOR WALL & CEILING LUMINAIRES 180             | <b>Case</b><br><br>OUTDOOR WALL & CEILING LUMINAIRES 184      |
| <b>Argos</b><br><br>OUTDOOR WALL & CEILING LUMINAIRES 186             | <b>Bronco</b><br><br>OUTDOOR WALL & CEILING LUMINAIRES 190          | <b>Tube Mini</b><br><br>OUTDOOR WALL & CEILING LUMINAIRES 192     | <b>Tube Medium</b><br><br>OUTDOOR WALL & CEILING LUMINAIRES 194      | <b>Tube Maxi</b><br><br>OUTDOOR WALL & CEILING LUMINAIRES 196 |
| <b>Ram</b><br><br>OUTDOOR WALL & CEILING LUMINAIRES 200              | <b>Zouk</b><br><br>OUTDOOR WALL & CEILING LUMINAIRES 202           | <b>Lolite</b><br><br>OUTDOOR WALL & CEILING LUMINAIRES 206       | <b>Pluto Slim Ramp</b><br><br>OUTDOOR WALL & CEILING LUMINAIRES 208 | <b>I-brick</b><br><br>OUTDOOR WALL & CEILING LUMINAIRES 212  |
| <b>Quickstep</b><br><br>OUTDOOR WALL & CEILING LUMINAIRES 214       | <b>Golf</b><br><br>OUTDOOR WALL & CEILING LUMINAIRES 216          | <b>Drift</b><br><br>OUTDOOR WALL & CEILING LUMINAIRES 218       | <b>Huntsville</b><br><br>OUTDOOR WALL & CEILING LUMINAIRES 220     | <b>Retina</b><br><br>OUTDOOR WALL & CEILING LUMINAIRES 224  |
| <b>Retina Cross</b><br><br>OUTDOOR WALL & CEILING LUMINAIRES 226    | <b>Retina Eyelid</b><br><br>OUTDOOR WALL & CEILING LUMINAIRES 228 | <b>Retina Flat</b><br><br>OUTDOOR WALL & CEILING LUMINAIRES 230 | <b>Retina Maxi</b><br><br>OUTDOOR WALL & CEILING LUMINAIRES 232    | <b>Sylo</b><br><br>OUTDOOR WALL & CEILING LUMINAIRES 234    |
| <b>Polar</b><br><br>OUTDOOR WALL & CEILING LUMINAIRES 236           | <b>Flow</b><br><br>OUTDOOR WALL & CEILING LUMINAIRES 238          | <b>Athlon</b><br><br>OUTDOOR WALL & CEILING LUMINAIRES 240      | <b>Powerlug</b><br><br>FLOODLIGHTS 242                             | <b>Powerlug Mini</b><br><br>FLOODLIGHTS 244                 |

|   |  |   |  |   |
|---|--|---|--|---|
| <b>Flood</b><br><br>FLOODLIGHTS 246                        | <b>Sirocco</b><br><br>FLOODLIGHTS 248                     | <b>Flowerpower</b><br><br>OUTDOOR SPOTS 250          | <b>Avenida Led</b><br><br>PARK LUMINAIRES 254             | <b>Avenida Lens Led</b><br><br>PARK LUMINAIRES 256   |
| <b>Avenida Heritage P</b><br><br>PARK LUMINAIRES 258       | <b>Avenida Heritage Lens P</b><br><br>PARK LUMINAIRES 260 | <b>Avenida Heritage C</b><br><br>PARK LUMINAIRES 262 | <b>Avenida Heritage Lens C</b><br><br>PARK LUMINAIRES 264 | <b>Avenida Heritage S</b><br><br>PARK LUMINAIRES 266 |
| <b>Avenida Heritage Lens S</b><br><br>PARK LUMINAIRES 268 | <b>Artera</b><br><br>PARK LUMINAIRES 270                 | <b>Fremont</b><br><br>PARK LUMINAIRES 274           | <b>Tube Maxi Pole light</b><br><br>PARK LUMINAIRES 276   | <b>Avenida Bollard</b><br><br>BOLLARDS 280          |
| <b>Se7en</b><br><br>BOLLARDS 282                         | <b>Charisma medium</b><br><br>BOLLARDS 284              | <b>Macron Flat</b><br><br>BOLLARDS 286             | <b>Agar</b><br><br>BOLLARDS 288                         | <b>Traffik R</b><br><br>STREET LIGHTING 292        |
| <b>Urbino Led</b><br><br>STREET LIGHTING 294             | <b>Urbino Led Plus</b><br><br>STREET LIGHTING 296       |   |  |   |

Decorative downlight luminaire for suspended ceilings, degree of water and dust-proof IP20 and IP44, for LED light sources, UGR<19 (selected models).

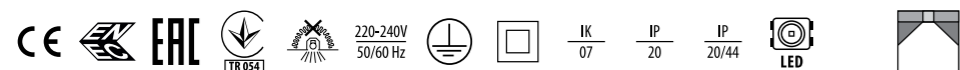

**TECHNICAL DATA** **Mounting:** in the ceiling, with mounting brackets (included)  
**Body:** aluminum  
**Colour:** white

**ELECTRICAL DATA** **Power:** 220-240V 50/60Hz  
**Includes light source:** yes  
**Type of equipment:** ON/OFF, DALI  
**Electrical connection:** max 3x2,5 mm<sup>2</sup> wire, loopable

**OPTICAL DATA** **Light distribution:** rotationally-symmetric  
**Way of lighting:** direct  
**Reflector:** aluminum mat faceted

**GENERAL DATA** **Lifetime (L80B10):** 50 000 h  
**SDCM:** 3  
**Warranty:** 5 years  
**Application:** shopping centers, museums, galleries, exhibitions, offices, hotels, public utility facilities, flats



| Electrical number                                 | Code         | Replacement (W) | Beam angle | (W) | (Lm) | (lm/W) | (K)  | CRI/Ra | (°C)      | IP      |
|---|--------------|-----------------|------------|-----|------|--------|------|--------|-----------|---------|
| <b>Protection Class I (W240 H140 mm, 0,7 kg)</b>  |              |                 |            |     |      |        |      |        |           |         |
| 42 459 00   | 300031.00008 | 2x26W (64W)     | 70°        | 24  | 2500 | 104    | 4000 | ≥80    | 0 ... +35 | IP20/44 |
| <b>Protection Class II (W240 H136 mm, 1,3 kg)</b> |              |                 |            |     |      |        |      |        |           |         |
| 42 459 01   | 300031.00059 | 2x42W (102W)    | 70°        | 44  | 4100 | 93     | 4000 | ≥80    | 0 ... +35 | IP20/44 |
| <b>DALI (W240 H105 mm, 0,7 kg)</b>                |              |                 |            |     |      |        |      |        |           |         |
| 42 427 51   | 300031.00040 | 2x26W (64W)     | 70°        | 26  | 2700 | 104    | 4000 | ≥80    | 0 ... +35 | IP20/44 |
| <b>DALI n/t (W242 H238 mm, 1,2 kg)</b>            |              |                 |            |     |      |        |      |        |           |         |
|   | 300031.00072 | 2x26W (64W)     | 70°        | 26  | 2700 | 104    | 4000 | ≥80    | 0 ... +35 | IP20/44 |
|   | 300031.00064 | 2x42W (102W)    | 70°        | 44  | 4100 | 93     | 4000 | ≥80    | 0 ... +35 | IP20/44 |
| <b>Standard n/t (W242 H238 mm, 1,7 kg)</b>        |              |                 |            |     |      |        |      |        |           |         |
|   | 300031.00045 | 2x26W (64W)     | 70°        | 24  | 2500 | 104    | 4000 | ≥80    | 0 ... +35 | IP20/44 |
|   | 300031.00062 | 2x42W (102W)    | 70°        | 44  | 4100 | 93     | 4000 | ≥80    | 0 ... +35 | IP20/44 |

Also available in following colours

- Black (RAL 9005)
  - White (RAL 9010)
  - All RAL colours
- Reflector can be painted also

**OTHER PICTURES**



**DIMENSIONAL DRAWING**

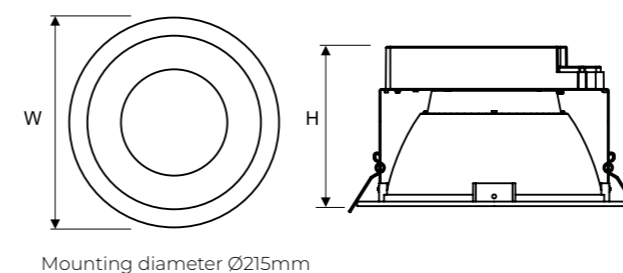

**ACCESSORIES**

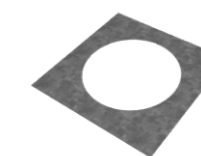

Mounting plate for ceilings with low mechanical durability  
**150100.00921**

**LIGHT BEAM CURVES**

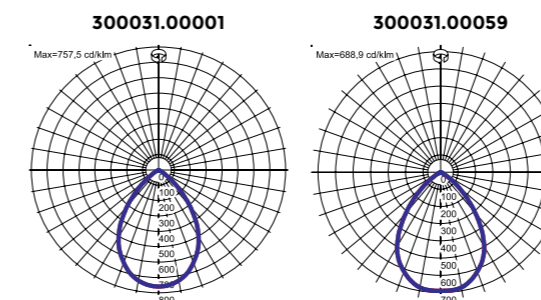

**OTHER PROJECTS**



**LUG LED Competence Center**  
Nowy Ksielín, Poland



**Supermarket Intermarche**  
Czarnków, Poland



**LHL Hospital**  
Oslo, Norway

Decorative downlight luminaire, adapted for tool-free assembly, for suspended ceilings, with LED light sources. The luminaire in round version with different angles of light distribution.

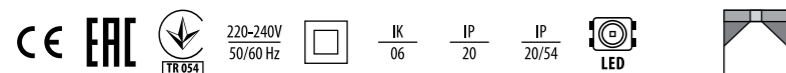

**TECHNICAL DATA**  
**Mounting:** in the ceiling, with mounting brackets (included)  
**Body:** aluminum  
**Colour:** white, black  
**Diffuser:** polycarbonate

**ELECTRICAL DATA**  
**Power:** 220-240V 50/60Hz  
**Includes light source:** yes  
**Type of equipment:** ON/OFF  
**Electrical connection:** max 2x1,5 mm<sup>2</sup> wire, max 4x1,5 mm<sup>2</sup> wire

**OPTICAL DATA**  
**Light distribution:** rotationally-symmetric  
**Way of lighting:** direct  
**Reflector:** polished faceted

**GENERAL DATA**  
**Lifetime (L80B10):** 60 000 h  
**Additional information:** Safe power supply with low voltage SELV  
**SDCM:** 3  
**Available on request:** DALI  
**Warranty:** 5 years  
**Application:** public utility facilities, delicatessen, supermarkets, shopping centers, offices, car showrooms, pathways, halls, classrooms, corridors, flats

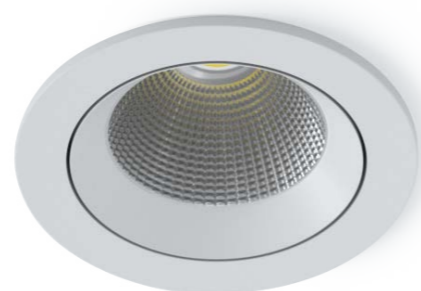

INTO R55

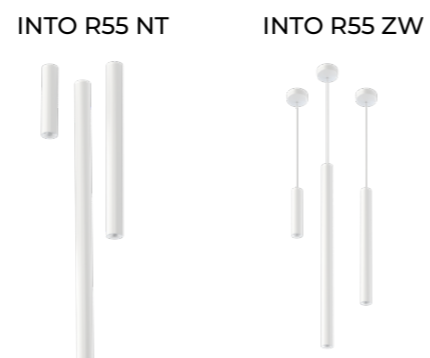

OTHER PICTURES



| Electrical number                            | Code            | Colour | Beam angle | (W) | (Lm) | (lm/W) | (K)  | CRI/Ra | (°C)      |
|--|-----------------|--------|------------|-----|------|--------|------|--------|-----------|
| <b>Into R55 IP20 (W55 H47 mm, 0,2 kg)</b>    |                 |        |            |     |      |        |      |        |           |
| 42 459 19                                    | 030601.5L01.311 | white  | 34°        | 6   | 700  | 117    | 3000 | ≥80    | 0 ... +45 |
| 42 459 20                                    | 030601.5L01.321 | white  | 45°        | 6   | 720  | 120    | 3000 | ≥80    | 0 ... +45 |
| 42 459 21                                    | 030601.5L01.331 | white  | 60°        | 6   | 720  | 120    | 3000 | ≥80    | 0 ... +45 |
| 42 459 22                                    | 030601.5L02.311 | white  | 34°        | 6   | 720  | 120    | 4000 | ≥80    | 0 ... +45 |
| 42 459 23                                    | 030601.5L02.321 | white  | 45°        | 6   | 720  | 120    | 4000 | ≥80    | 0 ... +45 |
| 42 459 24                                    | 030601.5L02.331 | white  | 60°        | 6   | 720  | 120    | 4000 | ≥80    | 0 ... +45 |
| 42 459 43                                    | 030603.5L01.313 | white  | 43°        | 6   | 700  | 117    | 3000 | ≥80    | 0 ... +45 |
| 42 459 44                                    | 030603.5L01.323 | black  | 45°        | 6   | 720  | 120    | 3000 | ≥80    | 0 ... +45 |
| 42 459 45                                    | 030603.5L01.333 | black  | 60°        | 6   | 720  | 120    | 3000 | ≥80    | 0 ... +45 |
| 42 459 46                                    | 030603.5L02.313 | black  | 34°        | 6   | 700  | 117    | 4000 | ≥80    | 0 ... +45 |
| 42 459 47                                    | 030603.5L02.323 | black  | 45°        | 6   | 720  | 120    | 4000 | ≥80    | 0 ... +45 |
| 42 459 48                                    | 030603.5L02.333 | black  | 60°        | 6   | 720  | 120    | 4000 | ≥80    | 0 ... +45 |
| <b>Into R55 IP20/54 (W60 H53 mm, 0,2 kg)</b> |                 |        |            |     |      |        |      |        |           |
|  | 030721.XL01.3XX | white  |            | 6   | 640  | 107    | 3000 | ≥80    | 0 ... +45 |
|  | 030721.XL02.3XX | white  |            | 6   | 640  | 107    | 4000 | ≥80    | 0 ... +45 |
|  | 030723.XL01.3XX | black  |            | 6   | 640  | 107    | 3000 | ≥80    | 0 ... +45 |
|  | 030723.XL02.3XX | black  |            | 6   | 640  | 107    | 4000 | ≥80    | 0 ... +45 |

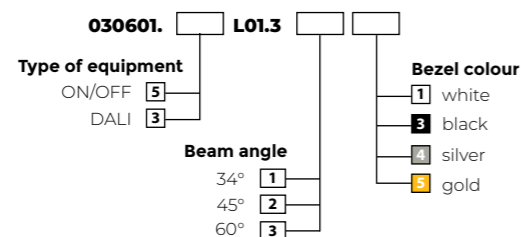

DIMENSIONAL DRAWING

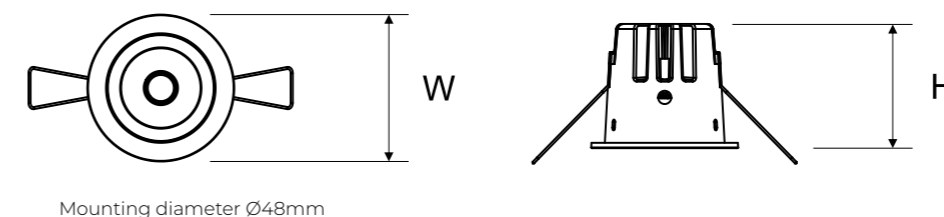

LIGHT BEAM CURVES

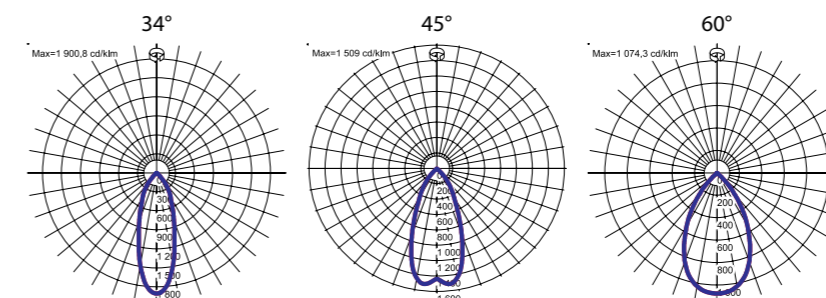



Decorative downlight luminaire, adapted for tool-free assembly, for suspended ceilings, with LED light sources. The luminaire in round version with different angles of light distribution.

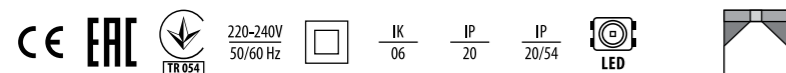

**TECHNICAL DATA** **Mounting:** in the ceiling, with mounting brackets (included)  
**Body:** aluminum  
**Colour:** white, black  
**ELECTRICAL DATA** **Power:** 220-240V 50/60Hz  
**Includes light source:** yes  
**Type of equipment:** ON/OFF  
**Electrical connection:** max 2x1,5 mm<sup>2</sup> wire, max 4x1,5 mm<sup>2</sup> wire  
**OPTICAL DATA** **Light distribution:** rotationally-symmetric  
**Way of lighting:** direct  
**Reflector:** polished faceted  
**ULOR / DLOR:** 0/100  
**GENERAL DATA** **Lifetime (L80B10):** 60 000 h  
**SDCM:** 3  
**Available on request:** DALI  
**Warranty:** 5 years  
**Application:** public utility facilities, delicatessen, supermarkets, shopping centers, offices, car showrooms, pathways, halls, classrooms, corridors, flats



INTO R100

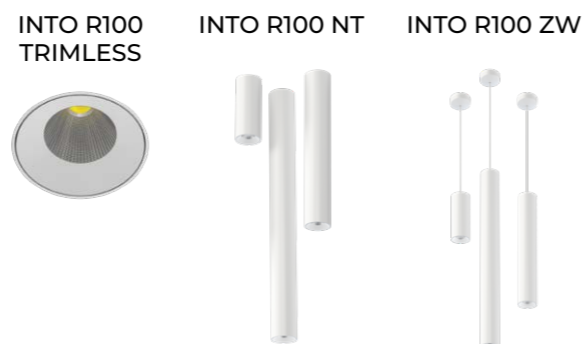

INTO R100 TRIMLESS

INTO R100 NT

INTO R100 ZW

| Electrical number                                    | Code            | Colour | Beam angle | (W) | (Lm) | (lm/W) | (K)  | CRI/Ra | (°C)      |
|--|-----------------|--------|------------|-----|------|--------|------|--------|-----------|
| <b>Into R100 IP20 (W100 H68 mm, 0,5 kg)</b>          |                 |        |            |     |      |        |      |        |           |
| 42 459 26  | 030551.5L01.321 | white  | 28°        | 14  | 1250 | 89     | 3000 | ≥80    | 0 ... +40 |
| 42 459 27  | 030551.5L01.331 | white  | 34°        | 14  | 1250 | 89     | 3000 | ≥80    | 0 ... +40 |
| 42 459 29  | 030551.5L02.321 | white  | 28°        | 14  | 1350 | 96     | 4000 | ≥80    | 0 ... +40 |
| 42 459 30  | 030551.5L02.331 | white  | 34°        | 14  | 1350 | 96     | 4000 | ≥80    | 0 ... +40 |
| 42 459 31  | 030551.5L03.311 | white  | 18°        | 21  | 1800 | 86     | 4000 | ≥80    | 0 ... +40 |
| 42 459 32  | 030551.5L03.321 | white  | 28°        | 21  | 1750 | 83     | 4000 | ≥80    | 0 ... +40 |
| 42 459 50  | 030553.5L01.323 | black  | 28°        | 14  | 1250 | 89     | 3000 | ≥80    | 0 ... +40 |
| 42 459 51  | 030553.5L01.333 | black  | 34°        | 14  | 1250 | 89     | 3000 | ≥80    | 0 ... +40 |
| 42 459 53  | 030553.5L02.323 | black  | 28°        | 14  | 1350 | 96     | 4000 | ≥80    | 0 ... +40 |
| 42 459 54  | 030553.5L02.333 | black  | 34°        | 14  | 1350 | 96     | 4000 | ≥80    | 0 ... +40 |
| 42 459 56  | 030553.5L03.323 | black  | 28°        | 21  | 1750 | 83     | 3000 | ≥80    | 0 ... +40 |
| 42 459 57  | 030553.5L03.333 | black  | 34°        | 21  | 1750 | 83     | 3000 | ≥80    | 0 ... +40 |
| 42 459 59  | 030553.5L04.323 | black  | 28°        | 21  | 1850 | 88     | 4000 | ≥80    | 0 ... +40 |
| 42 459 60  | 030553.5L04.333 | black  | 34°        | 21  | 1850 | 88     | 4000 | ≥80    | 0 ... +40 |
| <b>Into R100 IP20/54, IK06 (W106 H73 mm, 0,5 kg)</b> |                 |        |            |     |      |        |      |        |           |
|  | 030631.5L02.3XX | white  |            | 14  | 1150 | 82     | 4000 | ≥80    | 0 ... +40 |
|  | 030631.5L04.3XX | white  |            | 21  | 1600 | 76     | 4000 | ≥80    | 0 ... +40 |
|  | 030633.5L02.3XX | black  |            | 14  | 1150 | 82     | 4000 | ≥80    | 0 ... +40 |
|  | 030633.5L04.3XX | black  |            | 21  | 1600 | 76     | 4000 | ≥80    | 0 ... +40 |

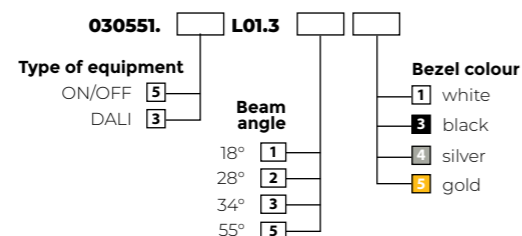

OTHER PICTURES



IP20/54



INTO R family



DIMENSIONAL DRAWING

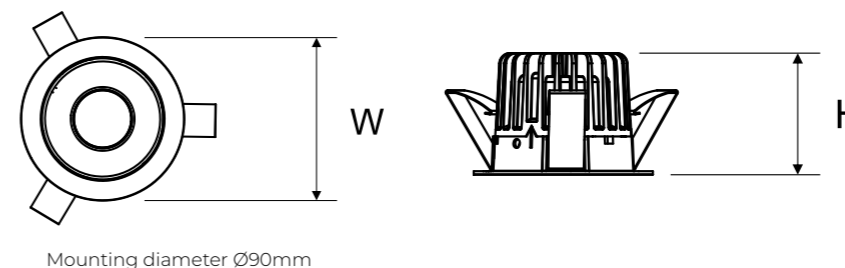

LIGHT BEAM CURVES

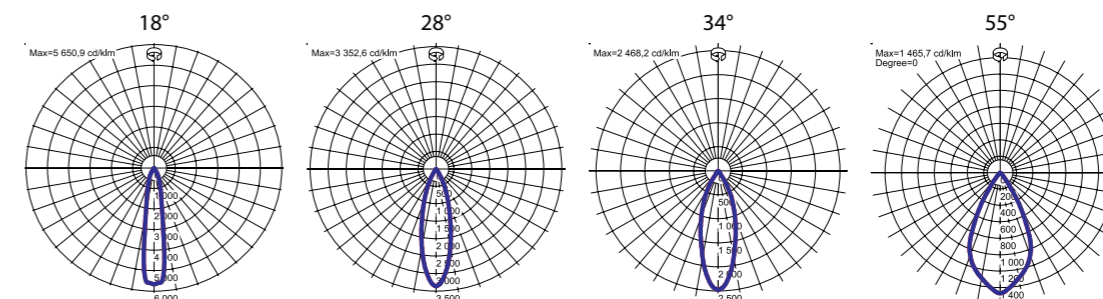

Decorative downlight luminaire, adapted for tool-free assembly, for suspended ceilings, with LED light sources. The luminaire in round version with different angles of light distribution.

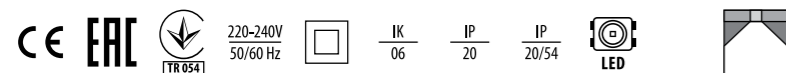

**TECHNICAL DATA** **Mounting:** in the ceiling, with mounting brackets (included)  
**Body:** aluminum  
**Colour:** white, black  
**ELECTRICAL DATA** **Power:** 220-240V 50/60Hz  
**Includes light source:** yes  
**Type of equipment:** ON/OFF  
**Electrical connection:** max 2x1,5 mm<sup>2</sup> wire, max 4x1,5 mm<sup>2</sup> wire  
**OPTICAL DATA** **Light distribution:** rotationally-symmetric  
**Way of lighting:** direct  
**Reflector:** polished faceted  
**GENERAL DATA** **Lifetime (L80B10):** 60 000 h  
**SDCM:** 3  
**Available on request:** DALI  
**Warranty:** 5 years  
**Application:** public utility facilities, delicatessen, supermarkets, shopping centers, offices, car showrooms, pathways, halls, classrooms, corridors, flats



INTO R160

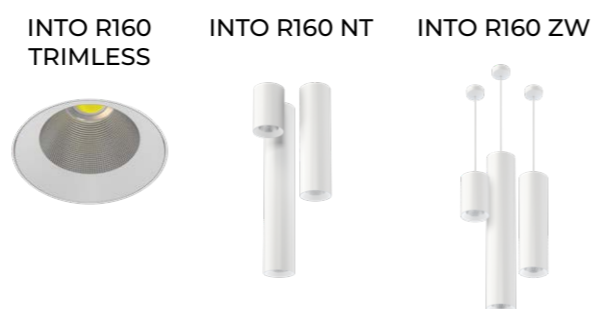

INTO R160 TRIMLESS

INTO R160 NT

INTO R160 ZW

OTHER PICTURES



IP20/54



INTO R family



finalist of the competition

DIMENSIONAL DRAWING

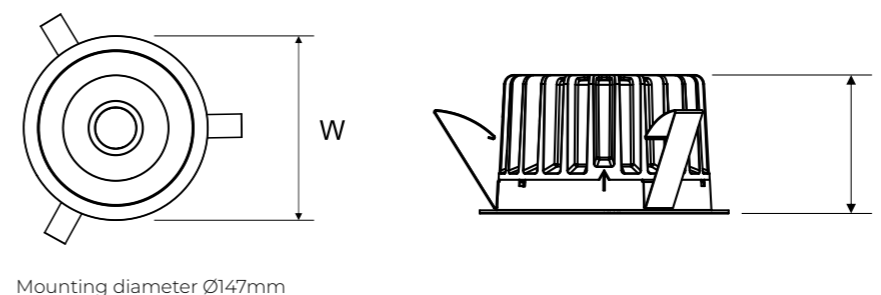

Mounting diameter Ø147mm

LIGHT BEAM CURVES

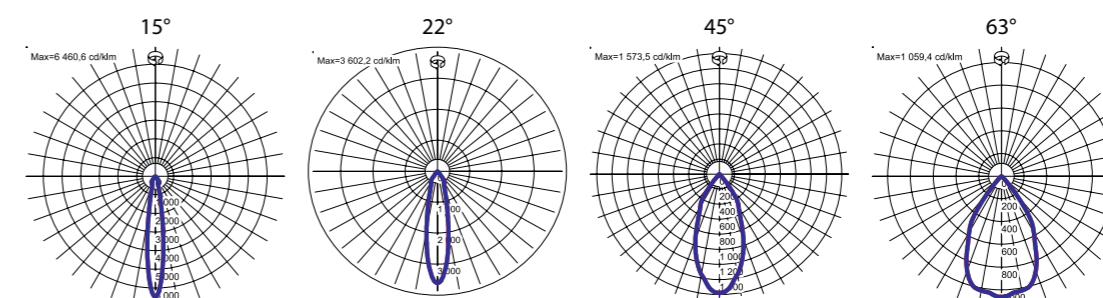

| Electrical number                                    | Code            | Colour | Beam angle | (W) | (Lm) | (lm/W) | (K)  | CRI/Ra | (°C)      |
|--|-----------------|--------|------------|-----|------|--------|------|--------|-----------|
| <b>Into R160 IP20 (W160 H88 mm, 0,9 kg)</b>          |                 |        |            |     |      |        |      |        |           |
| 42 459 33  | 030561.5L01.331 | white  | 45°        | 27  | 2600 | 96     | 3000 | ≥80    | 0 ... +35 |
| 42 459 36  | 030561.5L02.331 | white  | 45°        | 27  | 2700 | 100    | 4000 | ≥80    | 0 ... +35 |
| 42 459 39  | 030561.5L03.331 | white  | 45°        | 35  | 3200 | 91     | 3000 | ≥80    | 0 ... +35 |
| 42 459 42  | 030561.5L04.331 | white  | 45°        | 35  | 3350 | 96     | 4000 | ≥80    | 0 ... +35 |
| 42 459 63  | 030563.5L01.333 | black  | 45°        | 27  | 2600 | 96     | 3000 | ≥80    | 0 ... +35 |
| 42 459 66  | 030563.5L02.333 | black  | 45°        | 27  | 2700 | 100    | 4000 | ≥80    | 0 ... +35 |
| 42 459 69  | 030563.5L03.333 | black  | 45°        | 35  | 3200 | 91     | 3000 | ≥80    | 0 ... +35 |
| 42 459 72  | 030563.5L04.333 | black  | 45°        | 35  | 3350 | 96     | 4000 | ≥80    | 0 ... +35 |
| 42 459 94  | 030561.5L01.341 | white  | 63°        | 23  | 2600 | 113    | 3000 | ≥80    | 0 ... +35 |
| 42 459 95  | 030561.5L02.341 | white  | 63°        | 23  | 2750 | 120    | 4000 | ≥80    | 0 ... +35 |
| 42 459 96  | 030561.5L03.341 | white  | 63°        | 30  | 3350 | 112    | 3000 | ≥80    | 0 ... +35 |
| 42 459 97  | 030561.5L04.341 | white  | 63°        | 30  | 3550 | 118    | 4000 | ≥80    | 0 ... +35 |
| 42 459 98  | 030563.5L01.343 | black  | 63°        | 23  | 2600 | 113    | 3000 | ≥80    | 0 ... +35 |
| 42 459 99  | 030563.5L02.343 | black  | 63°        | 23  | 2750 | 120    | 4000 | ≥80    | 0 ... +35 |
| 42 838 00  | 030563.5L03.343 | black  | 63°        | 30  | 3350 | 112    | 3000 | ≥80    | 0 ... +35 |
| 42 838 01  | 030563.5L04.343 | black  | 63°        | 30  | 3550 | 118    | 4000 | ≥80    | 0 ... +35 |
| <b>Into R160 IP20/54, IK06 (W164 H93 mm, 0,9 kg)</b> |                 |        |            |     |      |        |      |        |           |
|  | 030641.5L02.3XX | white  |            | 23  | 2800 | 122    | 4000 | ≥80    | 0 ... +35 |
|  | 030641.5L04.3XX | white  |            | 30  | 3600 | 120    | 4000 | ≥80    | 0 ... +35 |
|  | 030643.5L02.3XX | black  |            | 23  | 2800 | 122    | 4000 | ≥80    | 0 ... +35 |
|  | 030643.5L04.3XX | black  |            | 30  | 3600 | 120    | 4000 | ≥80    | 0 ... +35 |

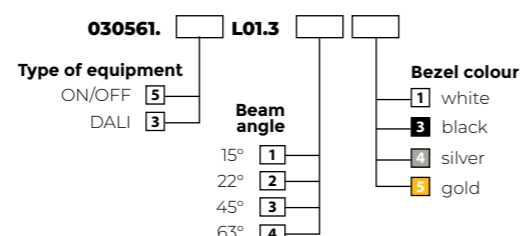



Decorative downlight luminaire, adapted for tool-free assembly, for suspended ceilings, with LED light sources. The luminaire in square version.

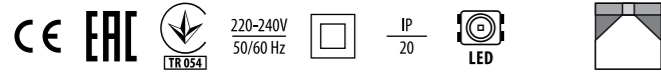

**TECHNICAL DATA** **Mounting:** in the ceiling, with mounting brackets (included)  
**Body:** high pressure die-cast aluminum, plastic  
**Colour:** white, black

**ELECTRICAL DATA** **Power supply efficiency:** 92%  
**Power:** 220-240V 50/60Hz  
**Includes light source:** yes  
**Type of equipment:** ON/OFF  
**Electrical connection:** max 2x1,5 mm<sup>2</sup> wire

**OPTICAL DATA** **Light distribution:** rotationally-symmetric  
**Way of lighting:** direct  
**Reflector:** polished faceted  
**ULOR / DLOR:** 0/100

**GENERAL DATA** **Lifetime (L80B10):** 60 000 h  
**Available on request:** DALI  
**Additional information:** safe power supply with low voltage SELV  
**SDCM:** 3  
**Warranty:** 5 years

**Application:** public utility facilities, delicatessen, supermarkets, shopping centers, offices, car showrooms, pathways, halls, boutiques, galleries, hotels, classrooms, corridors, flats

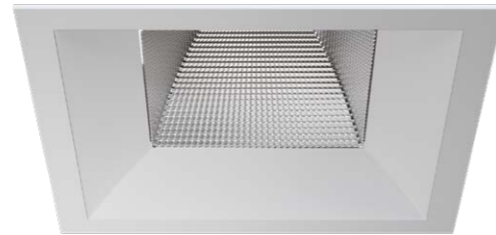

INTO S160

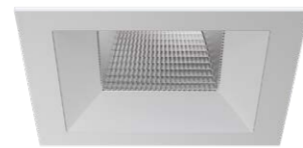

INTO S100

OTHER PICTURES



DIMENSIONAL DRAWING

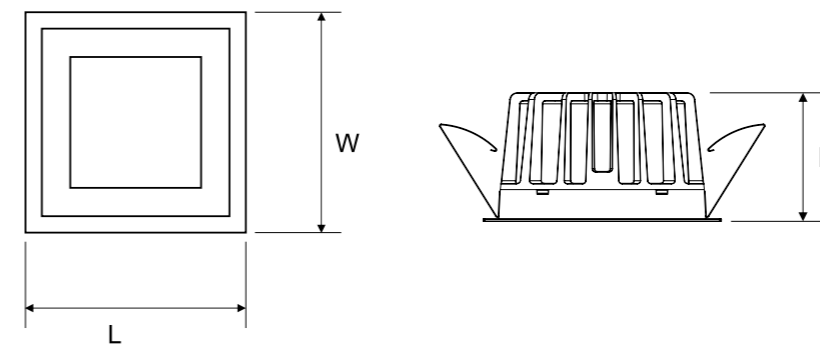

**Into S100**  
Mounting dimensions L90, W90

**Into S160**  
Mounting dimensions L150, W150

LIGHT BEAM CURVES

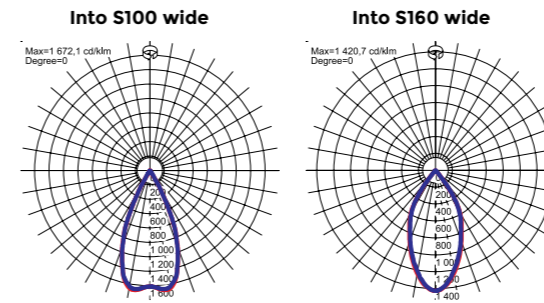

| Electrical number                           | Code            | Colour | Beam angle | (W) | (Lm) | (lm/W) | (K)  | CRI/Ra | (°C)      |
|---|-----------------|--------|------------|-----|------|--------|------|--------|-----------|
| <b>Into S100 (L100 W100 H60 mm, 0,4 kg)</b> |                 |        |            |     |      |        |      |        |           |
|   | 030581.5L01.33X | white  | 50°        | 14  | 1400 | 100    | 3000 | ≥80    | 0 ... +40 |
|   | 030581.5L02.33X | white  | 50°        | 14  | 1500 | 107    | 4000 | ≥80    | 0 ... +40 |
|   | 030581.5L03.33X | white  | 50°        | 20  | 1800 | 90     | 3000 | ≥80    | 0 ... +40 |
|   | 030581.5L04.33X | white  | 50°        | 20  | 1900 | 95     | 4000 | ≥80    | 0 ... +40 |
|   | 030583.5L01.33X | black  | 50°        | 14  | 1400 | 100    | 3000 | ≥80    | 0 ... +40 |
|   | 030583.5L02.33X | black  | 50°        | 14  | 1500 | 107    | 4000 | ≥80    | 0 ... +40 |
|   | 030583.5L03.33X | black  | 50°        | 20  | 1800 | 90     | 3000 | ≥80    | 0 ... +40 |
|   | 030583.5L04.33X | black  | 50°        | 20  | 1900 | 95     | 4000 | ≥80    | 0 ... +40 |
| <b>Into S160 (L160 W160 H80 mm, 0,9 kg)</b> |                 |        |            |     |      |        |      |        |           |
| 42 427 31                                   | 030591.5L02.331 | white  | 50°        | 22  | 2900 | 132    | 4000 | ≥80    | 0 ... +35 |
| 42 427 32                                   | 030591.5L04.331 | white  | 50°        | 30  | 3750 | 125    | 4000 | ≥80    | 0 ... +35 |
| 42 427 33                                   | 030593.5L02.333 | black  | 50°        | 22  | 2900 | 132    | 4000 | ≥80    | 0 ... +35 |
| 42 427 34                                   | 030593.5L04.333 | black  | 50°        | 30  | 3750 | 125    | 4000 | ≥80    | 0 ... +35 |

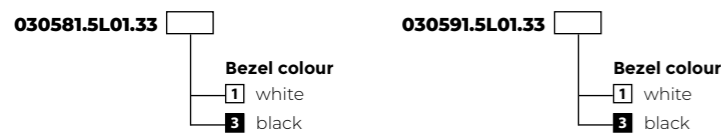

Also available in following colours

- Graphite (RAL 7016)
- Grey (RAL 7035)
- All RAL colours

StyloSoft is an exclusive surface mounted downlight in a stylish and durable aluminium housing. The luminaire has a deeply recessed light source with reflector optics for reduced glare and improved visual comfort. A luminaire which gives a comfortable and exclusive impression.

StyloSoft has a integrated LED and built-in dimmable LED driver. The luminaire is available in round or square shapes. The colour temperature is 2700K.

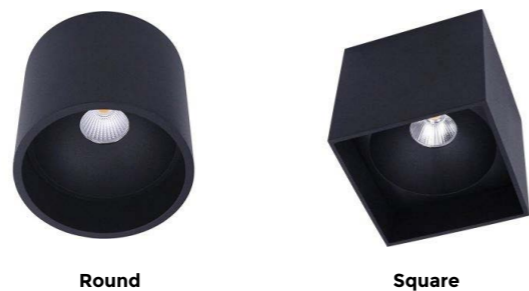

Round

Square

- TECHNICAL DATA** **Mounting:** surface mounting
- Body:** aluminium
- Colour:** black, white
- ELECTRICAL DATA** **Includes light source:** YES
- Power:** 230V 50-60Hz
- Type of equipment:** triac dimming
- OPTICAL DATA** **Light distribution:** symmetric
- Way of lighting:** direct
- GENERAL DATA** **Lifetime (L70B10):** 50 000 h
- SDCM:** 3
- Warranty:** 5 years

| Electrical number   | Code    | (IP) | (W) | (Lm) | (lm/W) | (K)  | CRI | Beam angle | Colour | Width/height/depth (mm) |
|---------------------|---------|------|-----|------|--------|------|-----|------------|--------|-------------------------|
| <b>StyloSoft R</b>  |         |      |     |      |        |      |     |            |        |                         |
| 41 263 02           | 3235730 | 23   | 7   | 800  | 114    | 2700 | 80  | 90°        | White  | 112/100                 |
| 41 263 03           | 3235731 | 23   | 7   | 800  | 114    | 2700 | 80  | 90°        | Black  | 112/100                 |
| <b>Stylosoft Sq</b> |         |      |     |      |        |      |     |            |        |                         |
| 41 263 04           | 3235735 | 23   | 7   | 800  | 114    | 2700 | 80  | 90°        | White  | 100/100/100             |
| 41 263 05           | 3235736 | 23   | 7   | 800  | 114    | 2700 | 80  | 90°        | Black  | 100/100/100             |

OTHER PICTURES



DIMENSIONAL DRAWING

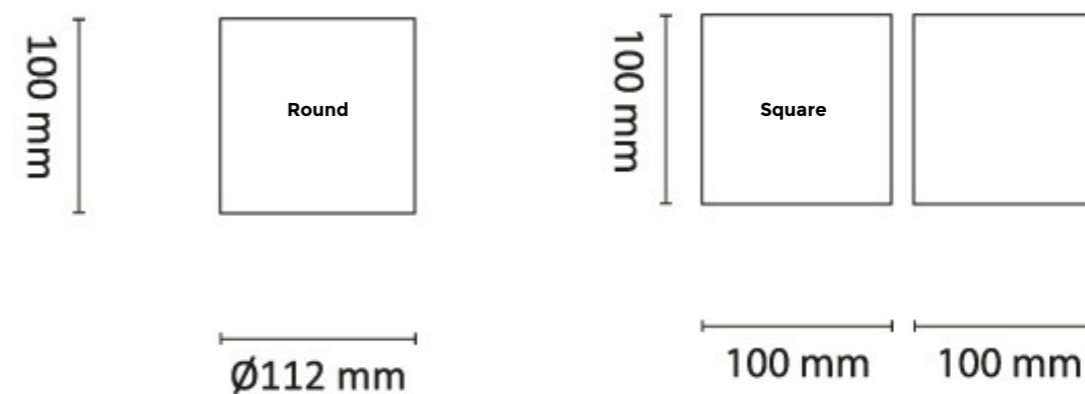

**Tilt - flexibility without limits with the new Tilt extra low-build downlight.** With Tilt, you can tilt the light in any direction, so you get the light where you want it. Elegant design with thinner flange which creates a nice transition between ceiling and downlight. An external dimmable LED driver are included, with pre-wiring between luminaire and LED driver. The connection in the LED driver is made by quick connectors with diverting capability and screw-less integrated cable strain relief. There is good connection space and extra terminal for the termination of earth conductor.

**Tilt** is equipped with a hi-spec CMD chip with Hi Ra/CRI colour rendering (>95) and a very low MacAdams colour-consistency (SDCM 2). Tilt has a long cable between the LED driver and the downlight with a quick connector. This solution makes it possible to separate the two parts during mounting, and there is also available a plugable DALI/1-10V/Pushdim driver to do a simple replacement of the original driver.

**Tilt Eco** use an SMD chip solution, with a lower Ra/CRI (>90) and a slightly higher colour deviation (SDCM 3). These lower values make a higher efficacy lumen/W. The Tilt Eco has a fixed cable between the LED driver and downlight, which makes it not possible in an easy way, to change to a DALI driver.

These products, both downlight and electronics, can be mounted covered by insulation mats, and they may both be used outdoors, 8W PrismaCOB LED lens optics. **Can be tilted 25° in all directions, 360°.** **Dimmable to very low level. IP44, Class II.**

- TECHNICAL DATA** Mounting: recessed  
Body: aluminium  
Colour: black, white
- ELECTRICAL DATA** Includes light source: YES  
Power: 230V 50-60Hz  
Type of equipment: Triac dimmable
- OPTICAL DATA** Light distribution: symmetric  
Way of lighting: direct
- GENERAL DATA** Lifetime (L70B10): 100 000 h  
SDCM: 2 (Tilt), 3 (Tilt Eco)  
Warranty: 5 years



Black



White

| Electrical number | Code    | (IP)  | (W) | (Lm) | (lm/W) | Beam angle | (K)  | CRI | Colour | Diameter/height (mm) |
|-------------------|---------|-------|-----|------|--------|------------|------|-----|--------|----------------------|
| <b>Tilt Eco</b>   |         |       |     |      |        |            |      |     |        |                      |
| 41 286 02         | 3236556 | 44/20 | 8   | 711  | 89     | 40°        | 3000 | 90  | White  | 92/36                |
| 41 620 21         | 3229360 | 44/20 | 8   | 711  | 89     | 40°        | 3000 | 90  | Black  | 92/36                |
| 41 620 22         | 3236557 | 44/20 | 8   | 740  | 93     | 40°        | 4000 | 90  | White  | 92/36                |
| 41 620 23         | 3229361 | 44/20 | 8   | 740  | 93     | 40°        | 4000 | 90  | Black  | 92/36                |
| <b>Tilt</b>       |         |       |     |      |        |            |      |     |        |                      |
| 41 015 04         | 3229433 | 44/20 | 8   | 600  | 75     | 40°        | 3000 | 95  | White  | 95/46                |
| 41 015 05         | 3229434 | 44/20 | 8   | 600  | 75     | 40°        | 3000 | 95  | Black  | 95/46                |
| 41 286 23         | 3229426 | 44/20 | 8   | 650  | 81     | 40°        | 4000 | 95  | White  | 95/46                |
| 41 286 24         | 3229427 | 44/20 | 8   | 650  | 81     | 40°        | 4000 | 95  | Black  | 95/46                |

OTHER PICTURES



DIMENSIONAL DRAWING

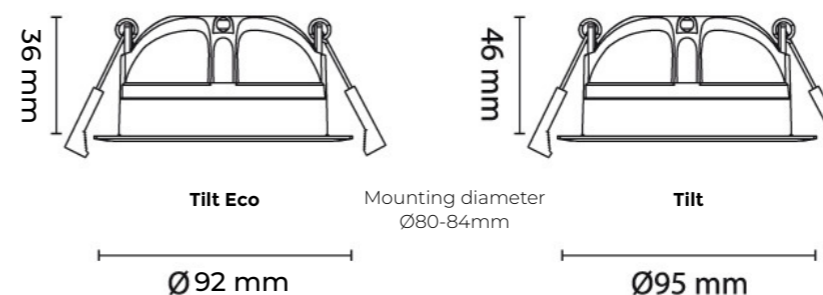

LIGHT BEAM CURVES

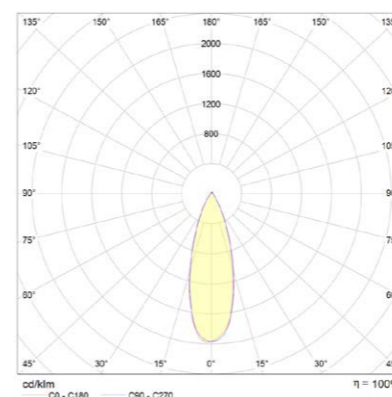

The downlights in the Half series all have lens optics for the most resemblance to halogen lamps and glare reduction. The colour rendering is very good with a high Ra value of Ra90+. A low recess height and a half-deep withdrawn LED gives the Half series an exclusive look in the ceiling.

Half comes complete with an external dimmable LED driver with pre-wiring between luminaire and LED driver. The connection in LED driver are made in quick connectors with diverting capability and screw-less integrated strain reliever. There is good connection space and extra terminal for the termination of earth conductor. This product, both downlight and electronics, can be mounted covered by insulation mats. Cut-out: 83-84mm. IP44 from underneath. Class II

- TECHNICAL DATA** **Mounting:** ceiling, recessed
- Body:** aluminium
- Colour:** black, white
- ELECTRICAL DATA** **Includes light source:** YES
- Power:** 230V 50-60Hz
- Type of equipment:** triac dimming
- OPTICAL DATA** **Light distribution:** symmetric 38°
- Way of lighting:** direct
- GENERAL DATA** **Lifetime (L70B10):** 50 000 h
- SDCM:** 3
- Warranty:** 5 years



Black



White

| Electrical number | Code    | (IP) | (W) | (Lm) | (lm/W) | (K)  | CRI | Colour | Diameter/depth (mm) |
|-------------------|---------|------|-----|------|--------|------|-----|--------|---------------------|
| 41 286 27         | 3229333 | 44   | 8   | 650  | 81     | 3000 | 93  | Black  | 95/34               |
| 41 286 28         | 3229334 | 44   | 8   | 650  | 81     | 3000 | 93  | White  | 95/34               |
| 41 620 24         | 3229358 | 44   | 8   | 730  | 91     | 4000 | 93  | Black  | 95/34               |
| 41 620 25         | 3229359 | 44   | 8   | 730  | 91     | 4000 | 93  | White  | 95/34               |

OTHER PICTURES



DIMENSIONAL DRAWING

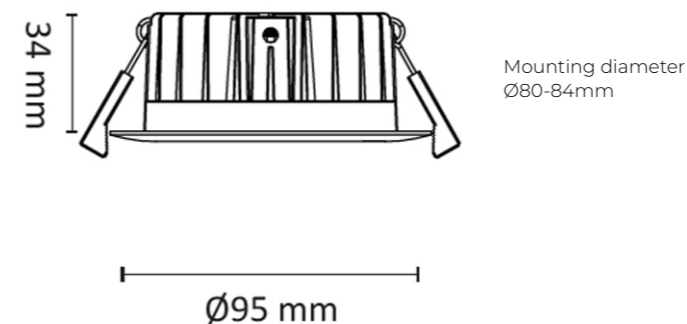

LIGHT BEAM CURVES

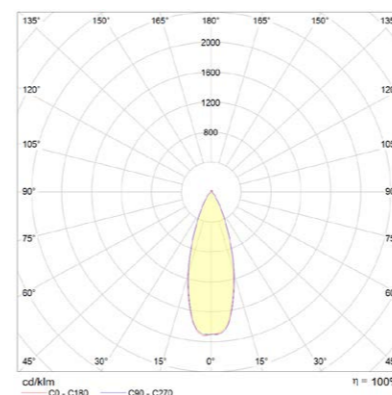





Hidden is a well designed recessed downlight, made with a very deep withdrawn lightsource. The steep angle of the lamp cup and very thin and narrow flange makes the impression of a trimless product - Hidden.

A high quality LED with very good color rendering (Ra), and a modern combined reflector with lens optics, providing low glare, high quality light.

The luminaire has very low build height and fits in 48 mm high downlight boxes. Hole dimensions 82-84 mm. The luminaire is dimmable to very low level by the newly developed flicker-free LED driver with pre-wiring between luminaire and LED driver. The Connection in LED driver are made in quick connectors with diverting capability and screw-less integrated strain reliever. Between the LED driver and luminaire there is an external quick connector for separating the luminaire and driver. This makes the downlight easy to mount and service. Hidden also comes in an asymmetric version with a fixed tilt of 34° inside. Class II, IP44 from underneath.

- TECHNICAL DATA** **Mounting:** ceiling, recessed
- Body:** aluminium
- Colour:** black, white
- ELECTRICAL DATA** **Includes light source:** YES
- Power:** 230V 50-60Hz
- Type of equipment:** triac dimming
- OPTICAL DATA** **Light distribution:** symmetric 34°
- Way of lighting:** direct
- GENERAL DATA** **Lifetime (L70B10):** 50 000 h
- SDCM:** 2
- Warranty:** 5 years



Black



White

| Electrical number | Code    | (IP) | (W) | (Lm) | (lm/W) | (K)  | CRI | Colour | Diameter/depth (mm) |
|-------------------|---------|------|-----|------|--------|------|-----|--------|---------------------|
| <b>Hidden</b>     |         |      |     |      |        |      |     |        |                     |
| 41 015 70         | 3236521 | 44   | 8   | 780  | 97,5   | 3000 | 95  | White  | 88/58               |
| 41 015 71         | 3236522 | 44   | 8   | 820  | 102,5  | 4000 | 95  | White  | 88/58               |
| 41 015 74         | 3236526 | 44   | 8   | 780  | 97,5   | 3000 | 95  | Black  | 88/58               |
| 41 015 75         | 3236527 | 44   | 8   | 820  | 102,5  | 4000 | 95  | Black  | 88/58               |

**OTHER PICTURES**



**DIMENSIONAL DRAWING**

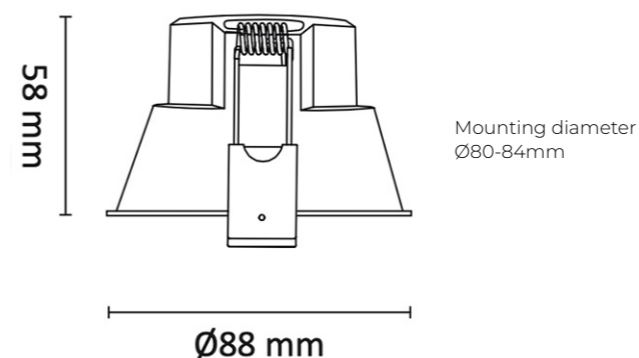

**LIGHT BEAM CURVES**

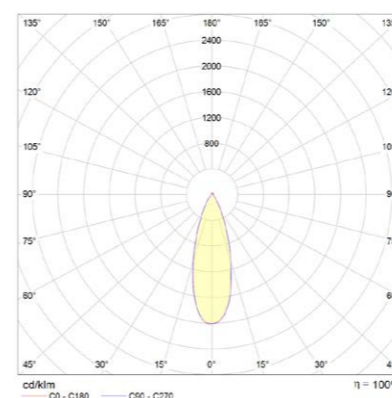

IP44 rated, CRI>90, adjustable, LED circular recessed triac-dimmable downlight

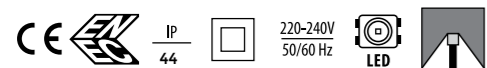

- CONSTRUCTION** **Mounting:** for recessed mounting  
**Body:** die-cast aluminium, adjustable  
**Reflector:** specular aluminium  
**Optic:** clear acrylic
- TECHNICAL DATA** **Driver:** separate, included  
**Dimming:** triac dimmable  
**Power factor:** >0.95  
**Electrical connection:** terminal block, 3 x 2 x 2.5mm<sup>2</sup>  
**Beam angle:** 36°
- GENERAL DATA** **Application:** meeting rooms, bathrooms, halls, living spaces  
**Operating temperature:** -20°C - +25°C  
**Lumen depreciation:** L70: 100,000 hours  
**SDCM:** <3  
**Warranty:** 5 years



| Electrical number    | Code           | W | lm  | lm/W | K    | CRI/Ra | Bezel colour |
|----------------------|----------------|---|-----|------|------|--------|--------------|
| <b>Burbank white</b> |                |   |     |      |      |        |              |
| 42 665 27            | NBU/6/G/930    | 6 | 599 | 97   | 3000 | ≥90    | White        |
| 42 665 29            | NBU/6/G/940    | 6 | 630 | 105  | 4000 | ≥90    | White        |
| <b>Burbank black</b> |                |   |     |      |      |        |              |
| 42 665 28            | NBU/6/BK/G/930 | 6 | 599 | 97   | 3000 | ≥90    | Black        |
| 42 665 30            | NBU/6/BK/G/940 | 6 | 630 | 105  | 4000 | ≥90    | Black        |

OTHER PICTURES



BURBANK white

BURBANK black

DIMENSIONAL DRAWING

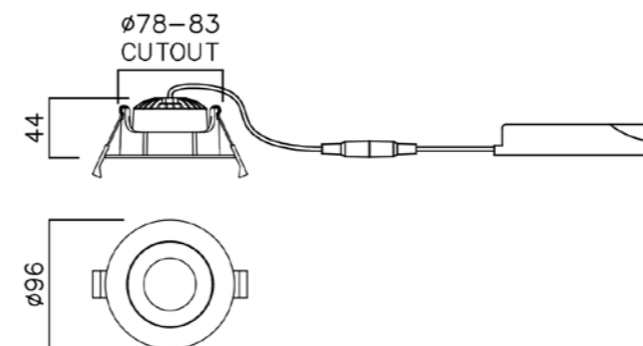

LIGHT BEAM CURVES

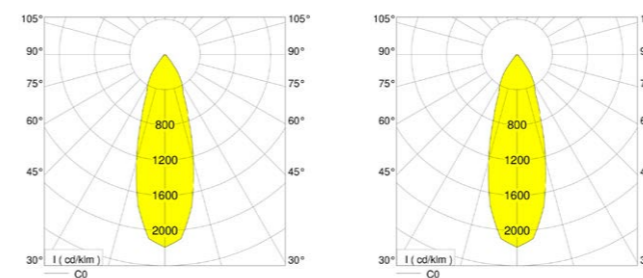

BURBANK 930

BURBANK 940



**TULSA**  
(page 46)

**LUGSTAR**  
(page 12)

Decorative downlight luminaire for suspended ceilings, with LED light sources.

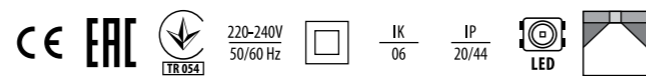

- TECHNICAL DATA** **Mounting:** in the ceiling, with mounting brackets (included)
- Body:** plastic
- Colour:** white
- Diffuser:** opal plexiglass (PLX)
- ELECTRICAL DATA** **Power supply efficiency:** 86%
- Power:** 220-240V 50/60Hz
- Includes light source:** yes
- Type of equipment:** ON/OFF, DALI
- Electrical connection:** max 2x1,5 mm<sup>2</sup> wire, loopable
- OPTICAL DATA** **Light distribution:** omnidirectional
- Way of lighting:** direct
- Reflector:** white, aluminum mat faceted
- GENERAL DATA** **Lifetime (L80B10):** 30 000 h
- Other remarks:** mounting in ceilings 8-25 mm thick
- SDCM:** 3
- Warranty:** 5 years
- Application:** shopping centers, halls, corridors, museums, galleries, exhibitions, offices, hotels, public utility facilities, flats



| Electrical number                         | Code         | Colour | Type of equipment | (W) | (Lm) | (lm/W) | (K)  | CRI/Ra | (°C)      |
|---|--------------|--------|-------------------|-----|------|--------|------|--------|-----------|
| <b>Lugstar Spot (W170 H90 mm, 0,4 kg)</b> |              |        |                   |     |      |        |      |        |           |
| 42 459 02                                 | 300031.00103 | white  | ON/OFF            | 13  | 1050 | 81     | 4000 | ≥80    | 0 ... +35 |
| 42 459 03                                 | 300031.00105 | white  | ON/OFF            | 20  | 1750 | 88     | 4000 | ≥80    | 0 ... +35 |

**Also available in following colours**

- Black (RAL 9005)
  - Grey (RAL 7035)
  - All RAL colours
- Reflector can be painted also

**OTHER PICTURES**



**DIMENSIONAL DRAWING**

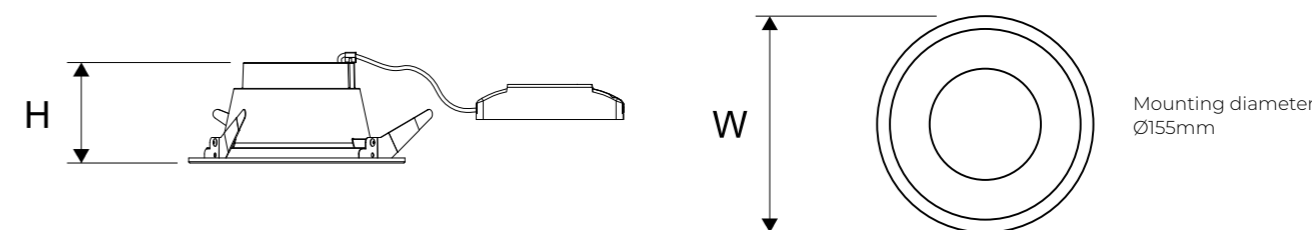

**LIGHT BEAM CURVES**

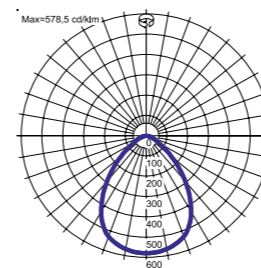

Lightbox is a series of exclusive surface mounted downlights in durable and stylish aluminium housings. The luminaire has a light source with the possibility to angle the light beam 25° in all directions. Lightbox comes in square design, complete with integrated dimmable LED driver. The luminaires has reflector optics with deep withdrawn light source for low glare and good visual comfort. Lightbox gives a comfortable and exclusive impression.

- TECHNICAL DATA** **Mounting:** surface mounting
- Body:** aluminium
- Colour:** black, white
- ELECTRICAL DATA** **Includes light source:** YES
- Power:** 230V 50-60Hz
- Type of equipment:** triac dimming
- OPTICAL DATA** **Light distribution:** symmetric 36°
- Way of lighting:** direct
- GENERAL DATA** **Lifetime (L70B10):** 50 000 h
- SDCM:** 3
- Warranty:** 5 years



Black

White

| Electrical number | Code    | (IP) | (W) | (Lm)  | (lm/W) | (K)  | CRI | Colour | Width/height/depth (mm) |
|-------------------|---------|------|-----|-------|--------|------|-----|--------|-------------------------|
| <b>Lightbox 1</b> |         |      |     |       |        |      |     |        |                         |
| 41 263 07         | 3235741 | 23   | 8   | 750   | 94     | 2700 | 90  | Black  | 95/105/95               |
| 41 263 06         | 3235740 | 23   | 8   | 750   | 94     | 2700 | 90  | White  | 95/105/95               |
| <b>Lightbox 2</b> |         |      |     |       |        |      |     |        |                         |
| 41 263 08         | 3235745 | 23   | 2x8 | 2x750 | 94     | 2700 | 90  | White  | 192/105/95              |
| 41 263 09         | 3235746 | 23   | 2x8 | 2x750 | 94     | 2700 | 90  | Black  | 192/105/95              |

OTHER PICTURES



e-number 41 263 09



e-number 41 263 08

DIMENSIONAL DRAWING

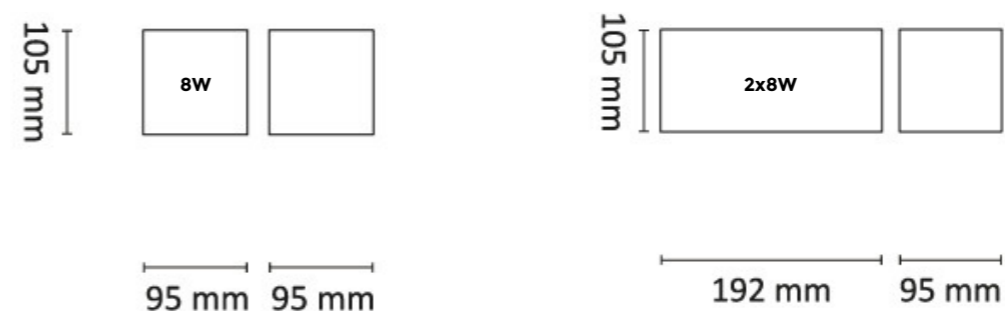

IP44 LED circular recessed triac-dimmable and colour selectable downlight

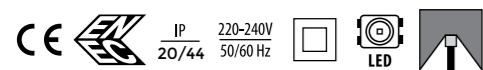

**CONSTRUCTION** Mounting: for recessed mounting  
Body: die-cast aluminium, white painted  
Optic: opal polycarbonate

**TECHNICAL DATA** Driver: separate, included  
Dimming: triac dimmable  
Power factor: >0.95  
Electrical connection: terminal block, 3 x 2 x 2.5mm<sup>2</sup>

**GENERAL DATA** Application: corridors, offices & general commercial use  
Operating temperature: -20°C - +25°C  
Lumen depreciation: L70: B10: 50,000 hours  
SDCM: <3  
Warranty: 5 years



| Electrical number     | Code                     | W    | lm   | lm/W | K          | CRI/Ra |
|-----------------------|--------------------------|------|------|------|------------|--------|
| <b>Harsted 100 mm</b> |                          |      |      |      |            |        |
| 42 665 07             | BB/NHR6/MD/CB3P/830-840  | 6.5  | 530  | 82   | 3000/4000K | ≥80    |
| <b>Harsted 140 mm</b> |                          |      |      |      |            |        |
| 42 665 08             | BB/NHR8/MD/CB3P/830-840  | 8.9  | 770  | 87   | 3000/4000K | ≥80    |
| <b>Harsted 170 mm</b> |                          |      |      |      |            |        |
| 42 665 09             | BB/NHR11/MD/CB3P/830-840 | 11.6 | 1050 | 91   | 3000/4000K | ≥80    |
| <b>Harsted 210 mm</b> |                          |      |      |      |            |        |
| 42 665 10             | BB/NHR14/MD/CB3P/830-840 | 13.8 | 1320 | 96   | 3000/4000K | ≥80    |

OTHER PICTURES



HARSTED is available in 4 sizes, 6, 8, 11 & 14W

DIMENSIONAL DRAWING

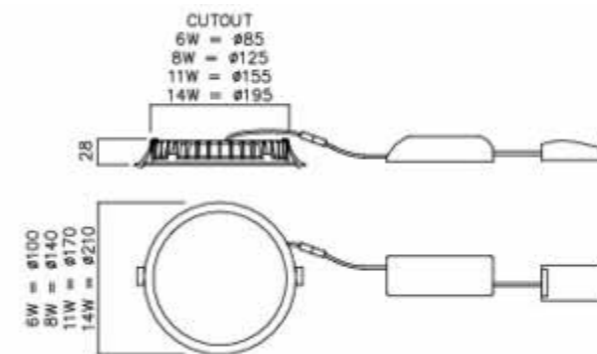

LIGHT BEAM CURVES

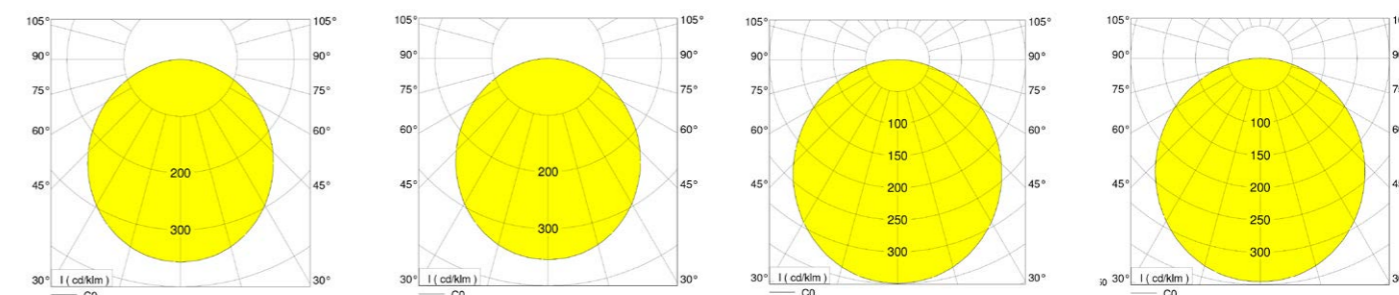

HARSTED 6W

HARSTED 8W

HARSTED 11W

HARSTED 14W



Edge-lit LED panel with UGR<19 option. Driver supplied separately.



**CONSTRUCTION** Body: steel, white painted RAL9016  
Bezel: aluminium, white painted RAL9016  
Structure: edge lit

**TECHNICAL DATA** Driver: purchased separately  
Dimming: as per driver  
Power factor: as per driver  
Electrical connection: as per driver

**GENERAL DATA** Application: offices, classrooms & general commercial use  
Operating temperature: -20°C - +25°C  
Lumen depreciation L90:B10:100,000  
SDCM: <3  
Warranty: 5 years



| Electrical number            | Code                | W         | lm        | lm/W | K    | CRI/Ra |
|------------------------------|---------------------|-----------|-----------|------|------|--------|
| <b>Tulsa opal</b>            |                     |           |           |      |      |        |
| 42 665 15                    | BB/NTU/O/66/830/ND  | 24.1/28.2 | 3395/4300 | 152  | 3000 | ≥80    |
| 42 665 16                    | BB/NTU/O/66/840/ND  | 24.1/28.2 | 3395/4300 | 152  | 4000 | ≥80    |
| <b>Tulsa micro prismatic</b> |                     |           |           |      |      |        |
| 42 665 17                    | BB/NTU/MP/66/830/ND | 24.1/28.2 | 3515/4405 | 157  | 3000 | ≥80    |
| 42 665 18                    | BB/NTU/MP/66/840/ND | 24.1/28.2 | 3515/4405 | 157  | 4000 | ≥80    |

**OTHER PICTURES**

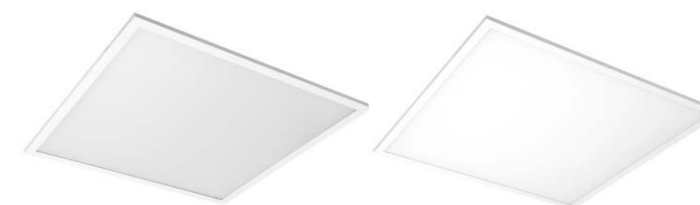

TULSA micro prismatic

TULSA opal

**DIMENSIONAL DRAWING**

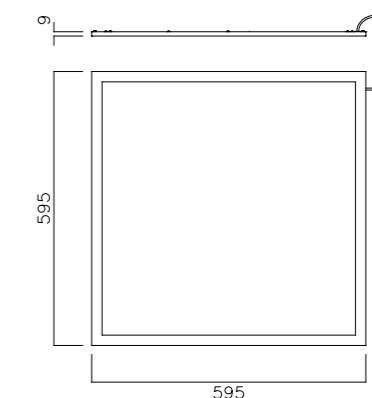

**LIGHT BEAM CURVES**

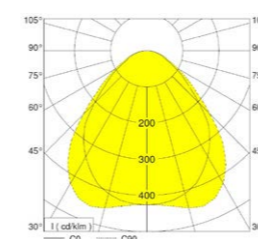

TULSA 24W MP 830

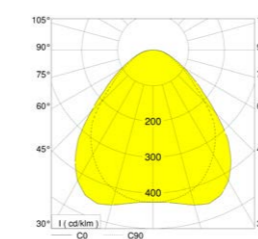

TULSA 24W MP 840

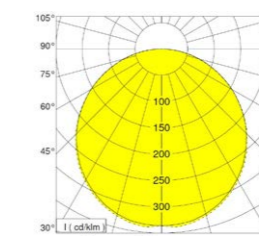

TULSA 24W O 830

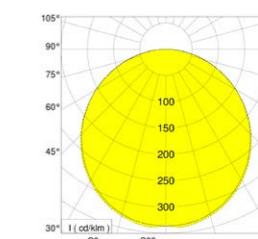

TULSA 24W O 840

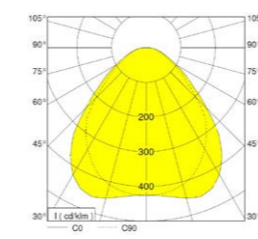

TULSA 28W MP 830

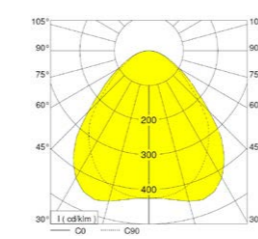

TULSA 28W MP 840

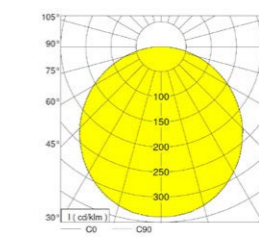

TULSA 28W O 830

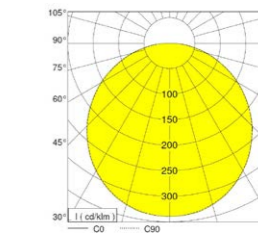

TULSA 28W O 840

**ACCESSORIES**



Surface-mounted frame  
42 665 04



Suspension  
42 665 35

**DRIVERS**



Driver Dali/SWD 24W  
40 665 06



Driver On/Off 24W  
40 665 10



Driver Dali/SWD 28W  
40 665 07



Driver On/Off 28W  
40 665 11



Back-lit LED panel



- CONSTRUCTION** Body: steel, white painted RAL9016  
Bezel: aluminium, white painted RAL9016  
Structure: back-lit
- TECHNICAL DATA** Driver: separate, included  
Dimming: DALI  
Power factor: >0,95  
Electrical connection: terminal block, 3 x 2 x 2.5mm<sup>2</sup>
- GENERAL DATA** Application: offices, classrooms & general commercial use  
Operating temperature: -20°C - +25°C  
Lumen depreciation: L70: B10: 50,000 hours  
SDCM: <5  
Warranty: 5 years



| Electrical number      | Code                 | Type of equipment | W  | lm   | lm/W | K    | CRI/Ra |
|------------------------|----------------------|-------------------|----|------|------|------|--------|
| <b>Opal</b>            |                      |                   |    |      |      |      |        |
| 42 665 23              | NFO/O/66/HO/840      | ON/OFF            | 40 | 4200 | 105  | 4000 | ≥80    |
| 42 556 24              | NFO/O/66/DD/HO/840   | DALI              | 40 | 4200 | 105  | 4000 | ≥80    |
| <b>Micro prismatic</b> |                      |                   |    |      |      |      |        |
| 42 665 25              | NFO/UGR/66/HO/840    | ON/OFF            | 40 | 4150 | 104  | 4000 | ≥80    |
| 42 665 26              | NFO/UGR/66/DD/HO/840 | DALI              | 40 | 4150 | 104  | 4000 | ≥80    |

OTHER PICTURES



FARGO is a back-lit panel which simplifies the internal structure

DIMENSIONAL DRAWING

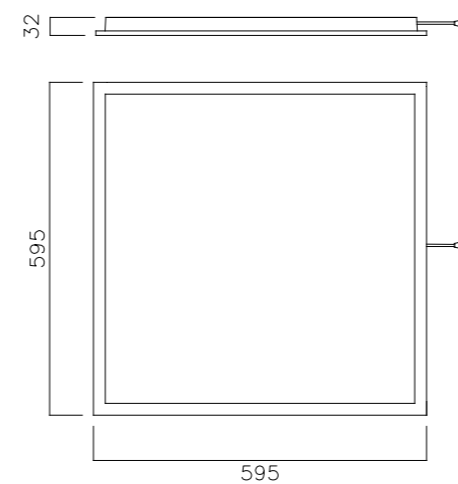

LIGHT BEAM CURVES

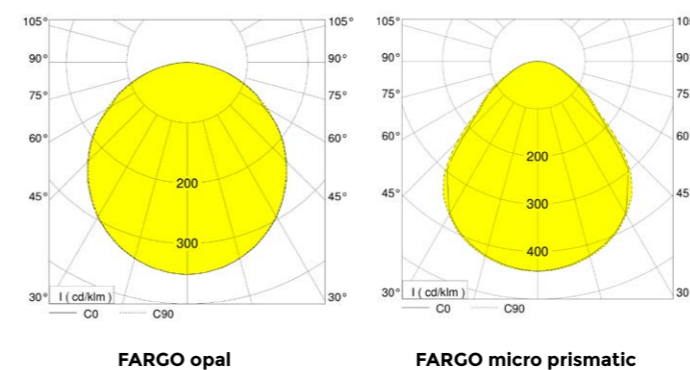



Modern recessed luminaire for modular suspended ceilings with LED light sources.



**TECHNICAL DATA** **Mounting:** directly in the ceiling construction  
**Body:** powder-painted steel sheet  
**Colour:** white

**ELECTRICAL DATA** **Power supply efficiency:** >90%  
**Power:** 220-240V 50/60Hz  
**Includes light source:** yes  
**Type of equipment:** ON/OFF  
**Electrical connection:** max 4x2,5 mm<sup>2</sup> wire

**OPTICAL DATA** **Light distribution:** symmetric  
**Way of lighting:** direct  
**Louver:** aluminum mat, matt white aluminum

**GENERAL DATA** **Lifetime (L80B10):** 50 000 h  
**Available on request:** DALI, EM 3h  
**SDCM:** 3  
**Warranty:** 5 years  
**Application:** offices, hospitals, laboratories, supermarkets, classrooms, auditorium



| Electrical number   | Code         | (W) | (Lm) | (lm/W) | (K)  | CRI/Ra | URG | (°C)      |
|---|--------------|-----|------|--------|------|--------|-----|-----------|
| <b>Office LB LED, louver: aluminum mat (L595 W595 H65 mm, 2,7 kg / 3,0 kg)</b>      |              |     |      |        |      |        |     |           |
| 42 427 39   | 300061.00117 | 29  | 3200 | 110    | 4000 | ≥80    | <17 | 0 ... +35 |
| 42 427 40   | 300061.00119 | 38  | 4300 | 113    | 4000 | ≥80    | <17 | 0 ... +35 |
| <b>Office PLUS LB LED, louver: aluminum mat (L595 W595 H65 mm, 3,0 kg / 3,4 kg)</b> |              |     |      |        |      |        |     |           |
| 42 427 41   | 300061.00203 | 38  | 4450 | 117    | 4000 | ≥80    | <17 | 0 ... +35 |
| 42 427 42   | 300061.00205 | 56  | 6350 | 113    | 4000 | ≥80    | <17 | 0 ... +35 |

Also available in following colours

- Black (RAL 9005)
- Graphite (RAL 7016)
- Grey (RAL 7035)
- All RAL colours

**OTHER PICTURES**



**DIMENSIONAL DRAWING**

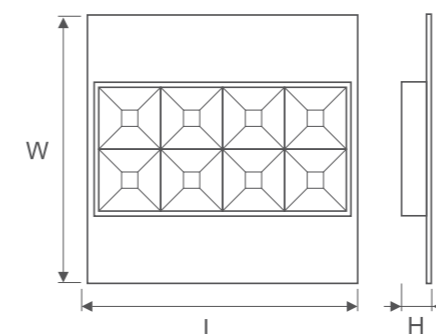

**LIGHT BEAM CURVES**

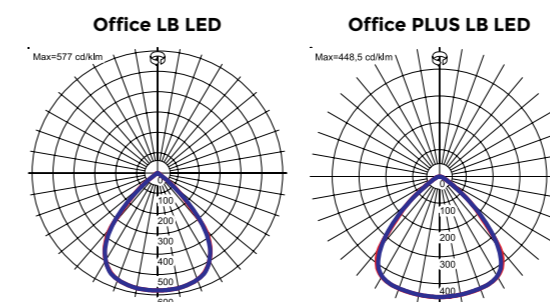

Modern direct-indirect light recessed luminaire for modular suspended ceilings featuring LED light sources.





- TECHNICAL DATA** **Mounting:** directly in the ceiling construction
- Body:** powder-painted steel sheet
- Colour:** white
- ELECTRICAL DATA** **Power supply efficiency:** >90%
- Power:** 220-240V 50/60Hz
- Includes light source:** yes
- Type of equipment:** ON/OFF
- Electrical connection:** max 3x2,5 mm<sup>2</sup> wire
- OPTICAL DATA** **Way of lighting:** indirect
- GENERAL DATA** **Lifetime (L80B10):** 50 000 h
- SDCM:** 3
- Available on request:** DALI
- Warranty:** 5 years
- Application:** auditorium, classrooms, museums, reception desks, restaurants, offices



| Electrical number                                 | Code            | (W) | (Lm) | (lm/W) | (K)  | CRI/Ra |
|---|-----------------|-----|------|--------|------|--------|
| <b>Soft Basic LED (L595 W595 H100 mm, 5,5 kg)</b> |                 |     |      |        |      |        |
| 42 427 35   | 050081.5L01.311 | 56  | 3200 | 57     | 3000 | ≥80    |
| 42 427 36   | 050081.5L02.311 | 56  | 3300 | 59     | 4000 | ≥80    |
| 42 427 37   | 050081.5L03.311 | 74  | 3900 | 53     | 3000 | ≥80    |
| 42 427 38   | 050081.5L04.311 | 74  | 4050 | 55     | 4000 | ≥80    |

**Also available in following colours**

-  Black (RAL 9005)
-  Graphite (RAL 7016)
-  Grey (RAL 7035)

**OTHER PICTURES**



**DIMENSIONAL DRAWING**

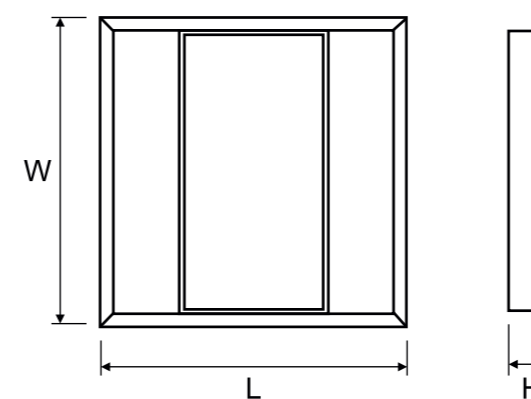

**LIGHT BEAM CURVES**

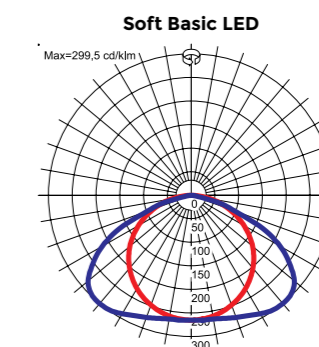

**ACCESSORIES**



Mounting frame for plasterboard ceilings 595x595 (mounting hole 615x615)  
**150210.00605**

**PROJECTS**



**Coty**  
Athens, Greece



Modern luminaire for modular ceilings for LED light sources.

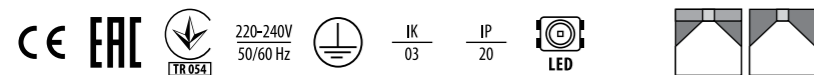

- TECHNICAL DATA**  
**Mounting:** directly in the ceiling construction on wire suspension (on request), with mounting brackets (on request)  
**Body:** powder-painted steel sheet  
**Colour:** white  
**Diffuser:** opal plexiglass (PLX)
- ELECTRICAL DATA**  
**Power supply efficiency:** >90%  
**Power:** 220-240V 50/60Hz  
**Includes light source:** yes  
**Type of equipment:** ON/OFF, DALI/Switch dim  
**Electrical connection:** max 3x1,5 mm<sup>2</sup> wire, max 5x1,5 mm<sup>2</sup> wire
- OPTICAL DATA**  
**Light distribution:** symmetric  
**Way of lighting:** direct  
**Louver:** aluminum mat
- GENERAL DATA**  
**Lifetime (L80B10):** 100 000 h  
**Operating temperature range:** 0 °C ... +40 °C  
**Additional information:** RAL 9003 matte  
**SDCM:** 3  
**Warranty:** 5 years  
**Application:** offices, classrooms, auditorium



| Electrical number   | Code            | Type of equipment | (W) | (Lm) | (lm/W) | (K)  | CRI/Ra |
|---|-----------------|-------------------|-----|------|--------|------|--------|
| <b>Office Flow (L1168/L1468 W142 H48 mm, 5,8 kg / 6,1 kg)</b> |                 |                   |     |      |        |      |        |
| 42 838 02   | 060351.5L01.211 | ED                | 40  | 4200 | 105    | 4000 | ≥80    |
| 42 838 03   | 060351.5L02.212 | ED                | 51  | 5200 | 102    | 4000 | ≥80    |
| 42 838 04   | 060351.3L01.211 | DALI/Switch dim   | 40  | 4200 | 105    | 4000 | ≥80    |
| 42 838 05   | 060351.3L02.212 | DALI/Switch dim   | 51  | 5200 | 102    | 4000 | ≥80    |

OTHER PICTURES



DIMENSIONAL DRAWING

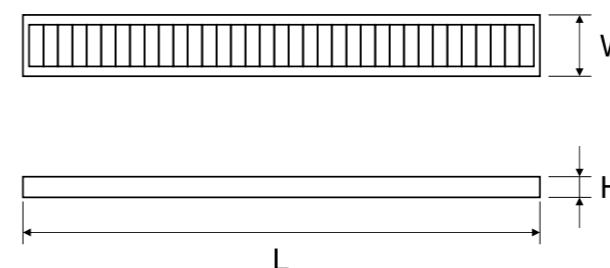

LIGHT BEAM CURVES

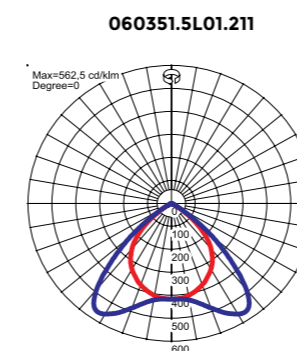

ACCESSORIES



**150231.01077**  
**e-number 42 838 07**  
 Mounting frame for recessed mounting of OFFICE FLOW LED 1195x145 (frame size: 1200x150)

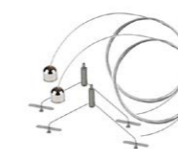

**150230.01079**  
**e-number 42 838 06**  
 Y-type suspension - set (2 pcs)



Suspended decorative luminaire for LED light sources; aluminum profile available in various colors, equipped with an efficient lighting system, optimized for indoor use.

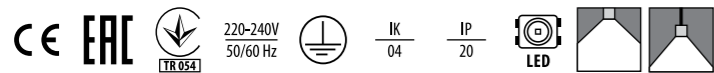

**TECHNICAL DATA**  
**Mounting:** suspended, on wire suspension (on request)  
**Body:** aluminum profile  
**Colour:** anode C-0, white, black  
**Diffuser:** opal matt (PMMA), microprismatic diffuser (MPRM)

**ELECTRICAL DATA**  
**Power supply efficiency:** >87%  
**Power:** 220-240V 50/60Hz  
**Includes light source:** yes  
**Type of equipment:** ON/OFF, DALI

**OPTICAL DATA**  
**Electrical connection:** luminaire equipped with 3x0,75 mm<sup>2</sup> wire with a length of 1.7 m (I class), luminaire equipped with 5x0,75 mm<sup>2</sup> wire with a length of 1.7 m (I class)  
**Light distribution:** omnidirectional  
**Way of lighting:** direct  
**Reflector:** white  
**ULOR / DLOR:** 0/100

**GENERAL DATA**  
**Lifetime (L80B10):** 100 000 h  
**Lifetime (L90B10):** 50 000 h  
**SDCM:** 3  
**Warranty:** 5 years  
**Application:** offices, hotels, reception desks, galleries, auditorium, boutiques, museums

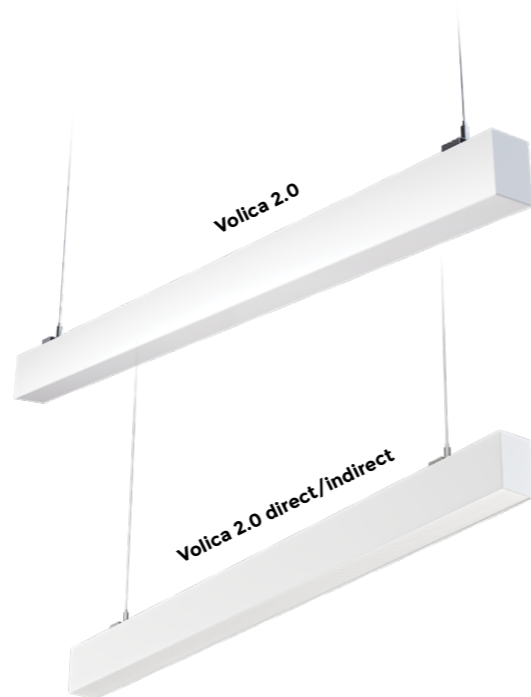

| Electrical number  | Code            | Length (mm) | (W) | (Lm) | (lm/W) | (K)  | CRI/Ra | (°C)      |
|--|-----------------|-------------|-----|------|--------|------|--------|-----------|
| <b>Opal diffuser - LOW - recommended for use in ceilings up to 3m high (L606/L1206/L1506/L2406 W60 H80 mm, 2,6-6,4 kg)</b> |                 |             |     |      |        |      |        |           |
|  | 010481.5L02.111 | 606         | 14  | 1750 | 125    | 4000 | ≥80    | 0 ... +35 |
|  | 010481.5L04.112 | 1206        | 28  | 3550 | 127    | 4000 | ≥80    | 0 ... +35 |
|  | 010481.5L06.113 | 1506        | 35  | 4400 | 126    | 4000 | ≥80    | 0 ... +35 |
|  | 010481.5L08.114 | 2406        | 56  | 7050 | 126    | 4000 | ≥80    | 0 ... +35 |
| <b>MPRM diffuser - LOW - recommended for use in ceilings up to 3m high (L606/L1206/L1506 W60 H80 mm, 2,6-4,5 kg)</b>       |                 |             |     |      |        |      |        |           |
|  | 010481.5L02.121 | 606         | 14  | 1850 | 132    | 4000 | ≥80    | 0 ... +35 |
|  | 010481.5L04.122 | 1206        | 28  | 3700 | 132    | 4000 | ≥80    | 0 ... +35 |
|  | 010481.5L06.123 | 1506        | 35  | 4650 | 133    | 4000 | ≥80    | 0 ... +35 |
|  | 010481.5L08.124 | 2406        | 56  | 7400 | 132    | 4000 | ≥80    | 0 ... +35 |
| <b>Opal direct - indirect (L1206/L1506/L2406 W60 H90 mm, 3,4 kg / 4,1 kg / 6,3 kg)</b>                                     |                 |             |     |      |        |      |        |           |
|  | 01051X.XL01.122 | 1206        | 32  | 4350 | 136    | 3000 | >80    | 0 ... +35 |
|  | 01051X.XL02.122 | 1206        | 32  | 4600 | 144    | 4000 | >80    | 0 ... +35 |
|  | 01051X.XL03.123 | 1506        | 40  | 5450 | 136    | 3000 | >80    | 0 ... +35 |
|  | 01051X.XL04.123 | 1506        | 40  | 5800 | 145    | 4000 | >80    | 0 ... +35 |
|  | 01051X.XL05.124 | 2406        | 64  | 8700 | 136    | 3000 | >80    | 0 ... +35 |
|  | 01051X.XL06.124 | 2406        | 64  | 9250 | 145    | 4000 | >80    | 0 ... +35 |

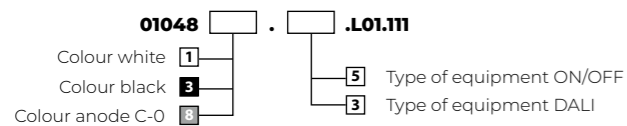

**Also available in following colours**

- Graphite (RAL 7016)
- Grey (RAL 7035)
- All RAL colours

**DIFFERENT MODELS/ALSO AVAILABLE**



**DIMENSIONAL DRAWING**

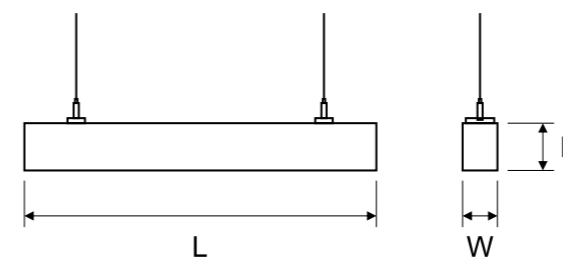

**LIGHT BEAM CURVES**

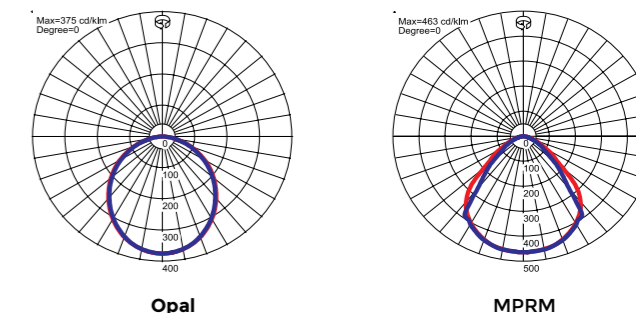

**ACCESSORIES**



150030.01050  
VOLICA 2.0 LED susp mechanical connector 90°



150060.00062  
Suspension hanger MINI



150061.00063  
150062.00064  
Mechanical round suspension



150061.00066  
150062.00067  
Mechanical round suspension with supply connector



Decorative system luminaire for LED light sources; aluminum profile available in various colors, equipped with an efficient lighting system, optimized for indoor use. The luminaire is available in surface-mounted or suspended version, depending on the purchased accessories.

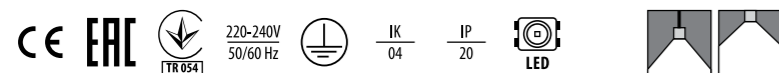

**TECHNICAL DATA** **Mounting:** suspended, on wire suspension (on request), surface mounted  
**Body:** aluminum profile  
**Colour:** anode C-0, white, black  
**Diffuser:** opal matt (PMMA), microprismatic diffuser (MPRM)

**ELECTRICAL DATA** **Power supply efficiency:** >87%  
**Power:** 220-240V 50/60Hz  
**Includes light source:** yes  
**Type of equipment:** ON/OFF, DALI  
**Electrical connection:** max 3x2,5 mm<sup>2</sup> wire, max 5x2,5 mm<sup>2</sup> wire

**OPTICAL DATA** **Light distribution:** omnidirectional  
**Way of lighting:** direct  
**Reflector:** white

**GENERAL DATA** **Lifetime (L80B10):** 100 000 h  
**Lifetime (L90B10):** 50 000 h  
**Warranty:** 5 years  
**Application:** offices, hotels, reception desks, galleries, auditorium, boutiques, museums

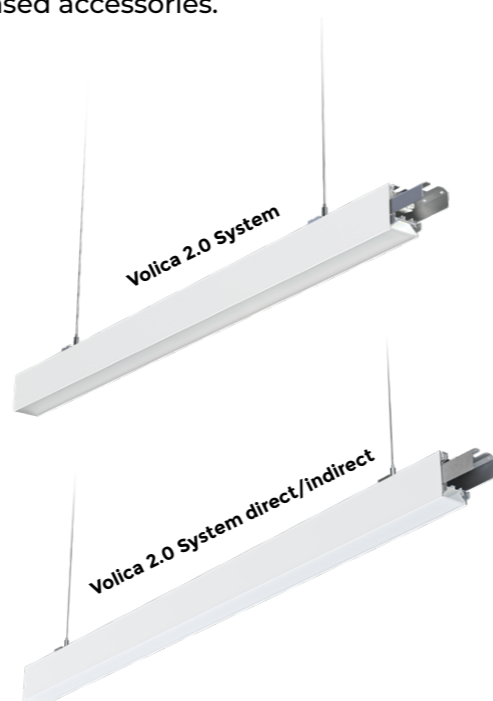

**DIFFERENT MODELS/ALSO AVAILABLE**

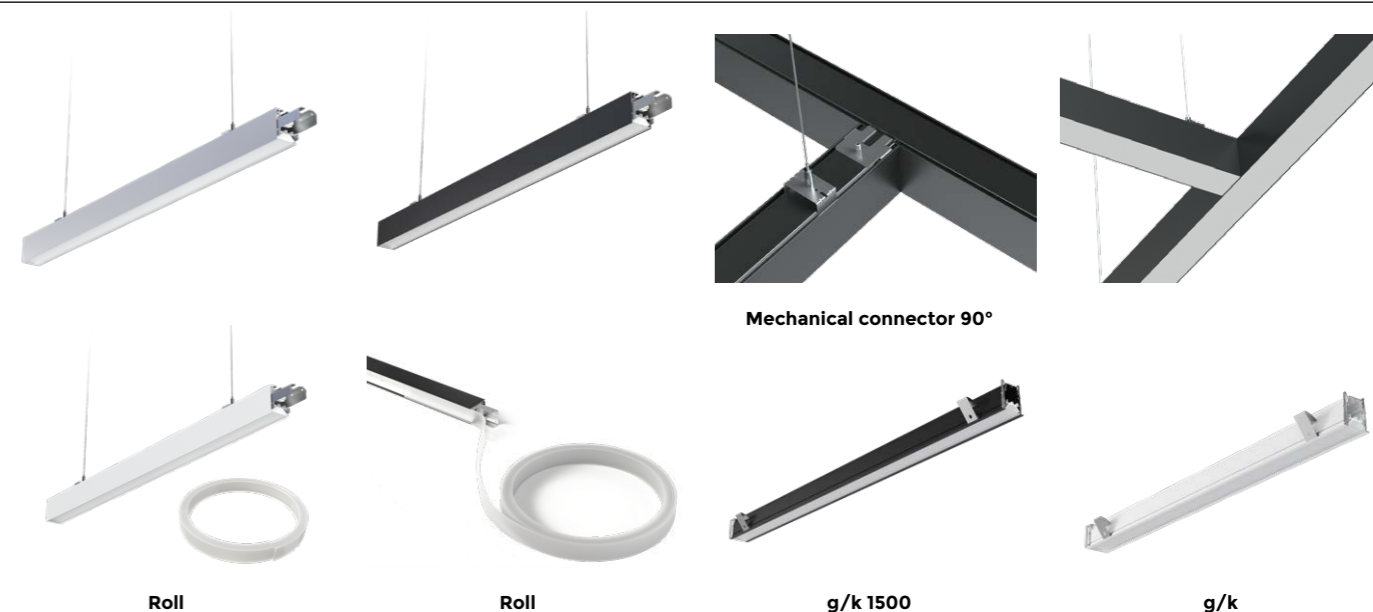

| Electrical number  | Code            | Length (mm) | (W) | (Lm) | (lm/W) | (K)  | CRI/Ra | (°C)      |
|--|-----------------|-------------|-----|------|--------|------|--------|-----------|
| <b>Opal diffuser - LOW - recommended for use in ceilings up to 3m high (L600/L1200/L1500/L2400 W60 H80 mm, 2,6-6,4 kg)</b> |                 |             |     |      |        |      |        |           |
|  | 010501.5L02.111 | 600         | 14  | 1750 | 125    | 4000 | ≥80    | 0 ... +35 |
|  | 010501.5L04.112 | 1200        | 28  | 3550 | 127    | 4000 | ≥80    | 0 ... +35 |
|  | 010501.5L06.113 | 1500        | 35  | 4400 | 126    | 4000 | ≥80    | 0 ... +35 |
|  | 010501.5L08.114 | 2400        | 56  | 7050 | 126    | 4000 | ≥80    | 0 ... +35 |
| <b>MPRM diffuser - LOW - recommended for use in ceilings up to 3m high (L600/L1200/L1500 W60 H80 mm, 2,6-4,5 kg)</b>       |                 |             |     |      |        |      |        |           |
|  | 010501.5L02.121 | 600         | 14  | 1850 | 132    | 4000 | ≥80    | 0 ... +35 |
|  | 010501.5L04.122 | 1200        | 28  | 3700 | 132    | 4000 | ≥80    | 0 ... +35 |
|  | 010501.5L06.123 | 1500        | 35  | 4650 | 133    | 4000 | ≥80    | 0 ... +35 |
|  | 010501.5L08.124 | 2400        | 56  | 7400 | 132    | 4000 | ≥80    | 0 ... +35 |
| <b>Direct - indirect (L1200/L1500/L2400 W60 H90 mm, 3,4 kg / 4,1 kg / 6,3 kg)</b>  |                 |             |     |      |        |      |        |           |
|  | 01052X.XL01.122 | 1200        | 32  | 4350 | 136    | 3000 | >80    | 0 ... +35 |
|  | 01052X.XL02.122 | 1200        | 32  | 4600 | 144    | 4000 | >80    | 0 ... +35 |
|  | 01052X.XL03.123 | 1500        | 40  | 5450 | 136    | 3000 | >80    | 0 ... +35 |
|  | 01052X.XL04.123 | 1500        | 40  | 5800 | 145    | 4000 | >80    | 0 ... +35 |
|  | 01052X.XL05.124 | 2400        | 64  | 8700 | 136    | 3000 | >80    | 0 ... +35 |
|  | 01052X.XL06.124 | 2400        | 64  | 9250 | 145    | 4000 | >80    | 0 ... +35 |

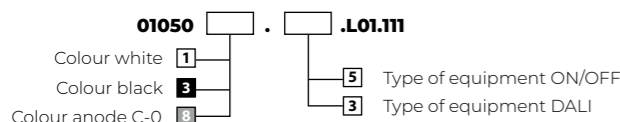

**Also available in following colours**

- Graphite (RAL 7016)
- Grey (RAL 7035)
- All RAL colours

**DIMENSIONAL DRAWING**

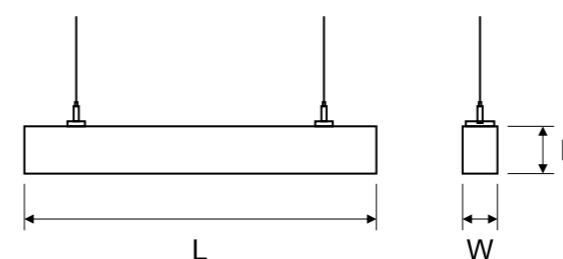

**LIGHT BEAM CURVES**

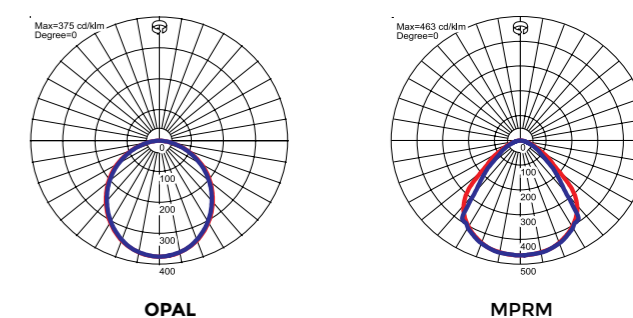

**ACCESSORIES**

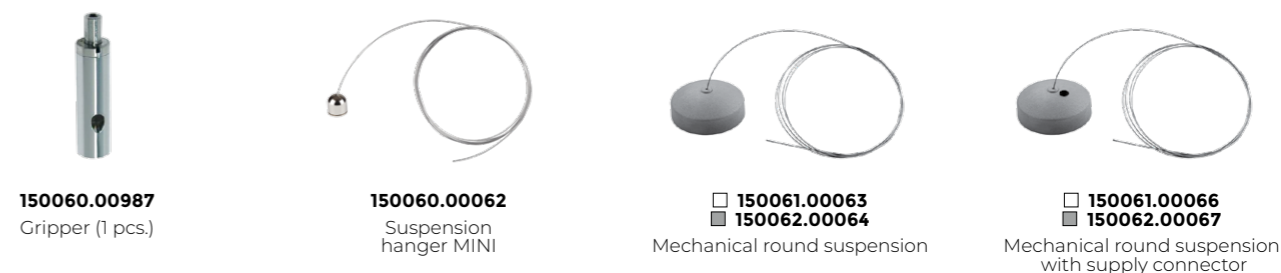

REXEL

REXEL

LUOTETTAVAA  
SÄHKÖTUKI  
- yhdessä jo

OMAM

Toteutetaan  
työmaalle ta  
- sinne, missä sähkö



www.rexel.fi



REXEL

ABB ABB

MITKÄ OLVAT TEE-SE-ITSE-MIENEN  
VIIMEISET SANAT?  
- Ei lassa mitään sähkömistä tarvikkeita

Prismian Group

Ettei nyt vaan sattuis mitään.



Turvallisuuden on varauduttava.  
Mieluiten laajin ja paras valinta on Laajakuulan  
kassatella. Täällä on Prismian laatuilla.

Prismian

Draka

Schneider Electric Life Is On Schneider Electric Life Is On Schneider Electric Life Is On



Decorative suspended luminaire, with LED light sources.

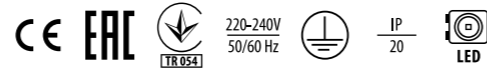

- TECHNICAL DATA**  
**Mounting:** on wire suspension (included)  
**Body:** aluminum profile  
**Colour:** white, black  
**Diffuser:** microprismatic diffuser (MPRM), microprismatic diffuser (MPRM) with lamella
- ELECTRICAL DATA**  
**Power supply efficiency:** >95%  
**Electrical connection:** luminaire equipped with 3x0,75 mm<sup>2</sup> wire with a length of 1.7 m (I class)  
**Power:** 220-240V 50/60Hz  
**Includes light source:** yes  
**Type of equipment:** ON/OFF  
**Electrical connection:** max 3x2,5 mm<sup>2</sup> wire, max 5x2,5 mm<sup>2</sup> wire
- OPTICAL DATA**  
**Light distribution:** very wide (>80°)  
**Way of lighting:** direct, direct-indirect  
**Type of optic:** diffuser, lamp diffuser with lamellar louvre  
**ULOR / DLOR:** 0/100, 57/43, 55/45, 60/40, 65/35
- GENERAL DATA**  
**Lifetime (L80B10):** 60 000 h  
**Other remarks:** the direct-indirect version lights up and down, UGR <19 for version with lamella  
**SDCM:** 3  
**Available on request:** DALI  
**Warranty:** 5 years  
**Application:** offices, boutiques, exhibitions, galleries, open-space areas, reception desks, conference rooms



OTHER PICTURES



DIMENSIONAL DRAWING

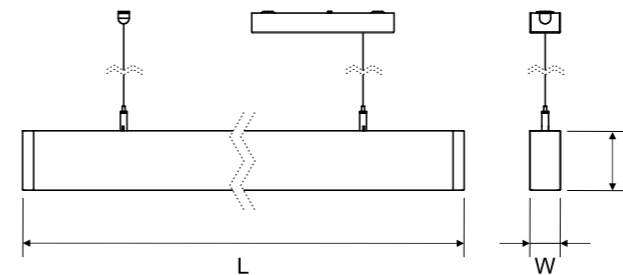

LIGHT BEAM CURVES

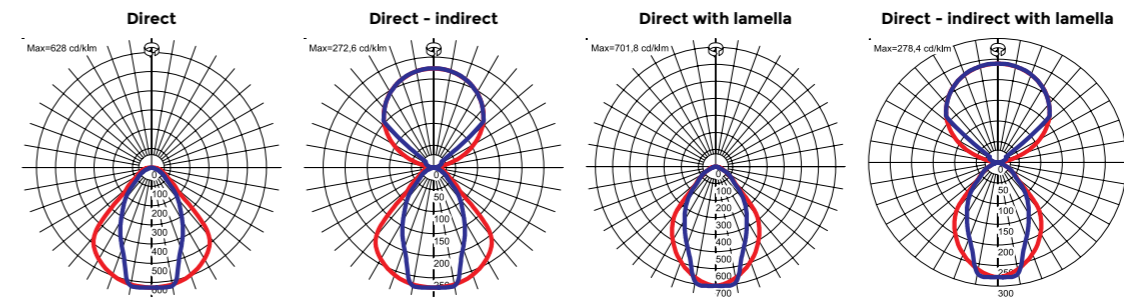

| Electrical number  | Code            | Colour | (W) | (Lm) | (lm/W) | (K)  | CRI/Ra | ULOR / DLOR | (°C)      |
|--|-----------------|--------|-----|------|--------|------|--------|-------------|-----------|
| <b>Direct (L1030 W40 H80 mm, 3,0 kg)</b>                         |                 |        |     |      |        |      |        |             |           |
| 42 459 86  | 010441.5L02.101 | white  | 30  | 2800 | 93     | 4000 | >80    | 0/100       | 0 ... +45 |
| 42 459 87  | 010443.5L02.101 | black  | 30  | 2500 | 83     | 4000 | >80    | 0/100       | 0 ... +45 |
| <b>Direct with lamella (L1030 W40 H80 mm, 3,0 kg)</b>            |                 |        |     |      |        |      |        |             |           |
| 42 459 88  | 010441.5L02.111 | white  | 30  | 2350 | 78     | 4000 | >80    | 0/100       | 0 ... +45 |
| 42 459 89  | 010443.5L02.131 | black  | 30  | 1650 | 55     | 4000 | >80    | 0/100       | 0 ... +45 |
| <b>Direct - indirect (L1030 W40 H80 mm, 3,0 kg)</b>              |                 |        |     |      |        |      |        |             |           |
| 42 459 90  | 010441.5L02.102 | white  | 57  | 6450 | 113    | 4000 | >80    | 57/43       | 0 ... +40 |
| 42 459 91  | 010443.5L02.102 | black  | 57  | 5550 | 97     | 4000 | >80    | 57/43       | 0 ... +40 |
| <b>Direct - indirect with lamella (L1030 W40 H80 mm, 3,0 kg)</b> |                 |        |     |      |        |      |        |             |           |
| 42 459 92  | 010441.5L02.112 | white  | 57  | 6050 | 106    | 4000 | >80    | 60/40       | 0 ... +40 |
| 42 459 93  | 010443.5L02.132 | black  | 57  | 4700 | 82     | 4000 | >80    | 60/40       | 0 ... +40 |

010441. .L01.101  
 Type of equipment ON/OFF  
 Type of equipment DALI

Also available in following colours  
 Graphite (RAL 7016)  
 Grey (RAL 7035)  
 All RAL colours



Decorative pendant luminaire.

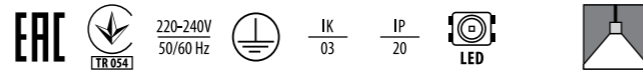

**TECHNICAL DATA** **Mounting:** suspended, on wire suspension (included), surface mounting  
**Body:** formed aluminum profile, plastic, steel sheet  
**Colour:** white, black  
**Diffuser:** opal plexiglass (PLX), microprismatic diffuser (MPRM)

**ELECTRICAL DATA** **Power supply efficiency:** >90%  
**Power:** 220-240V 50/60Hz  
**Includes light source:** yes  
**Type of equipment:** ON/OFF  
**Electrical connection:** max 3x0,75 mm<sup>2</sup> wire

**OPTICAL DATA** **Light distribution:** symmetric  
**Way of lighting:** direct  
**Type of optic:** diffuser  
**ULOR / DLOR:** 0/100

**GENERAL DATA** **Lifetime (L80B10):** 100 000 h  
**Operating temperature range:** 0°C ... +35°C  
**Available on request:** luminaire in other sizes  
**SDCM:** 3  
**Available on request:** DALI, 3000K  
**Warranty:** 5 years  
**Application:** offices, conference rooms, reception desks, shopping centers, car showrooms, boutiques

| Electrical number                 | Code            | Colour | Type of equipment | Beam angle | (W) | (Lm)  | (lm/W) | (K)  | CRI/Ra | Additional info | Diffuser |
|-----------------------------------|-----------------|--------|-------------------|------------|-----|-------|--------|------|--------|-----------------|----------|
| <b>Ø500 (W500 H80 mm, 3,0 kg)</b> |                 |        |                   |            |     |       |        |      |        |                 |          |
| 42 427 14                         | 200263.5L04.221 | black  | ON/OFF            | >80°       | 47  | 5000  | 106    | 4000 | 80     | surface         | OPAL     |
| 42 459 73                         | 200263.5L02.121 | black  | ON/OFF            | >80°       | 28  | 2900  | 104    | 4000 | 80     | suspended       | OPAL     |
| 42 459 74                         | 200263.5L04.121 | black  | ON/OFF            | >80°       | 47  | 5000  | 106    | 4000 | 80     | suspended       | OPAL     |
| <b>Ø700 (W700 H80 mm, 5,0 kg)</b> |                 |        |                   |            |     |       |        |      |        |                 |          |
| 42 427 15                         | 200261.5L08.232 | white  | ON/OFF            | >80°       | 75  | 9900  | 132    | 4000 | 80     | surface         | MPRM     |
| 42 427 17                         | 200261.5L08.131 | white  | ON/OFF            | >80°       | 75  | 7600  | 101    | 4000 | 80     | suspended       | OPAL     |
| 42 459 75                         | 200263.5L06.131 | black  | ON/OFF            | >80°       | 33  | 3800  | 115    | 4000 | 80     | suspended       | OPAL     |
| 42 459 76                         | 200263.5L08.131 | black  | ON/OFF            | >80°       | 70  | 7600  | 109    | 4000 | 80     | suspended       | OPAL     |
| <b>Ø900 (W900 H80 mm, 9,0 kg)</b> |                 |        |                   |            |     |       |        |      |        |                 |          |
| 42 427 16                         | 200263.5L12.242 | black  | ON/OFF            | >80°       | 83  | 12500 | 151    | 4000 | 80     | surface         | MPRM     |
| 42 427 18                         | 200261.5L12.142 | white  | ON/OFF            | >80°       | 83  | 12500 | 151    | 4000 | 80     | suspended       | MPRM     |
| 42 459 77                         | 200263.5L10.141 | black  | ON/OFF            | >80°       | 50  | 6200  | 124    | 4000 | 80     | suspended       | OPAL     |
| 42 459 78                         | 200263.5L12.141 | black  | ON/OFF            | >80°       | 83  | 10000 | 120    | 4000 | 80     | suspended       | OPAL     |

Also available in following colours

- Graphite (RAL 7016)
- Grey (RAL 7035)
- All RAL colours

OTHER PICTURES



DIMENSIONAL DRAWING

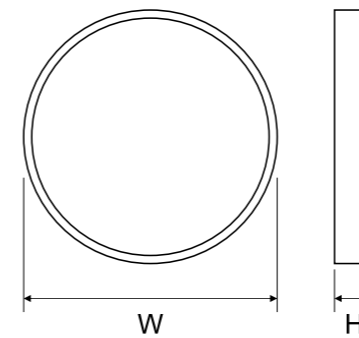

LIGHT BEAM CURVES

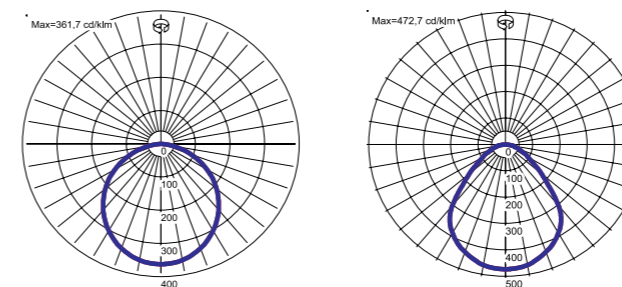

Aluminium framed luminaire for public facilities and markets. Wide range of optics and mounting options gives a good possibility for different kind of solutions. Led-module can be replaced.

- TECHNICAL DATA**  
**Mounting:** ceiling, wall, rail and suspended  
**Body:** aluminum profile  
**Colour:** gray, white on request  
**Diffuser:** micro prismatic (MP) & satin opal (SO) PMMA acrylic  
**Through wiring:** 2 x 5 x 2,5mm<sup>2</sup>
- ELECTRICAL DATA**  
**Power:** 230V 50Hz  
**Includes light source:** yes  
**Type of equipment:** ON/OFF
- OPTICAL DATA**  
**Light distribution:** symmetric  
**Way of lighting:** direct
- GENERAL DATA**  
**Lifetime (L80B50):** 100 000h  
**Available on request:** Dali or Dali/SWD, connection cables  
**SDCM:** 3  
**Warranty:** 5 years  
**Application:** public facilities and supermarkets



| Electrical number | (IP) | (W) | (Lm)  | (lm/W) | (K)  | Diffuser | CRI/Ra | C10/C16 | Length/width/height (mm) | Weight (kg) |
|-------------------|------|-----|-------|--------|------|----------|--------|---------|--------------------------|-------------|
| <b>BB 7080</b>    |      |     |       |        |      |          |        |         |                          |             |
| 43 625 00         | 44   | 28  | 3360  | 120    | 4000 | MP       | >80    | 23/39   | 1140/80/70               | 4           |
| 43 625 01         | 44   | 28  | 4030  | 144    | 4000 | SO       | >80    | 23/39   | 1140/80/70               | 4           |
| 43 625 02         | 44   | 35  | 4200  | 120    | 4000 | MP       | >80    | 23/39   | 1140/80/70               | 4           |
| 43 625 03         | 44   | 35  | 5040  | 144    | 4000 | SO       | >80    | 23/39   | 1140/80/70               | 4           |
| 43 625 04         | 44   | 45  | 5400  | 120    | 4000 | MP       | >80    | 23/39   | 1140/80/70               | 4           |
| 43 625 05         | 44   | 45  | 6480  | 144    | 4000 | SO       | >80    | 23/39   | 1140/80/70               | 4           |
| 43 625 06         | 44   | 56  | 6480  | 120    | 4000 | MP       | >80    | 23/39   | 1420/80/70               | 5           |
| 43 625 07         | 44   | 56  | 8060  | 144    | 4000 | SO       | >80    | 23/39   | 1420/80/70               | 5           |
| 43 625 08         | 44   | 69  | 8280  | 120    | 4000 | MP       | >80    | 23/39   | 1420/80/70               | 5           |
| 43 625 09         | 44   | 69  | 9930  | 144    | 4000 | SO       | >80    | 23/39   | 1420/80/70               | 5           |
| 43 625 10         | 44   | 75  | 11000 | 146    | 4000 | MP       | >80    | 12/28   | 1700/80/70               | 6           |
| 43 625 11         | 44   | 75  | 12000 | 160    | 4000 | SO       | >80    | 12/28   | 1700/80/70               | 6           |
| 43 625 12         | 44   | 92  | 13000 | 141    | 4000 | MP       | >80    | 12/28   | 2260/80/70               | 9           |
| 43 625 13         | 44   | 92  | 13900 | 151    | 4000 | SO       | >80    | 12/28   | 2260/80/70               | 9           |

**OTHER PICTURES**



Connection cables

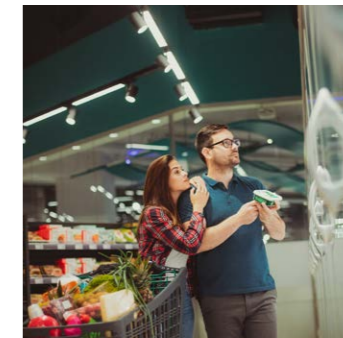

**DIMENSIONAL DRAWING**

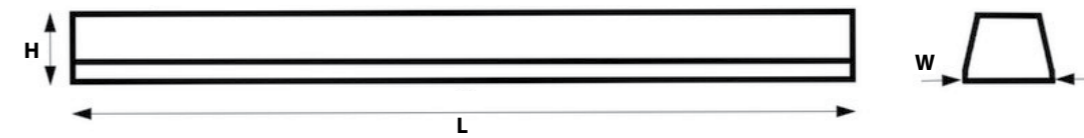

**LIGHT BEAM CURVES**

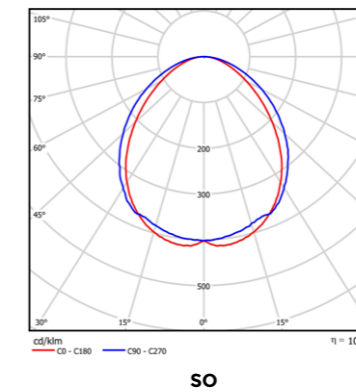
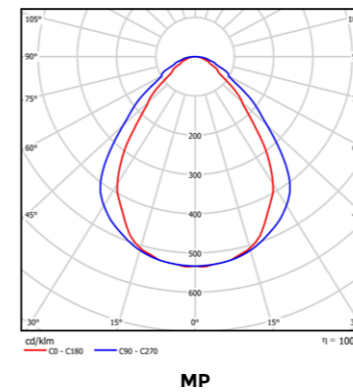



Modern projector for LED light sources.

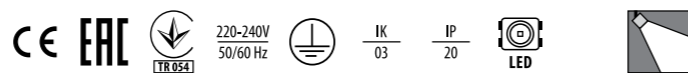

- TECHNICAL DATA** **Mounting:** in 3-phase track  
**Body:** high pressure die-cast aluminum  
**Colour:** white, black  
**Diffuser:** polycarbonate
- ELECTRICAL DATA** **Power supply efficiency:** >80%  
**Power:** 220-240V 50/60Hz  
**Includes light source:** yes  
**Type of equipment:** ON/OFF  
**Electrical connection:** in 3-phase track
- OPTICAL DATA** **Light distribution:** circular  
**Way of lighting:** direct  
**Reflector:** plastic polished
- GENERAL DATA** **Lifetime (L80B10):** 100 000 h  
**Operating temperature range:** 0°C ... +35°C  
**Additional information:** safe supply of the LED module with low SELV voltage  
**Available on request:** Dali  
**SDCM:** 3  
**Warranty:** 5 years  
**Application:** boutiques, delicatessen, jeweler, exhibitions, exhibitions, shopping centers, galleries, museums



| Electrical number  | Code            | (W) | (Lm) | (lm/W) | (K)  | CRI/Ra | (°C)      |
|--|-----------------|-----|------|--------|------|--------|-----------|
| <b>HI-CRI (L207 W87 H147 mm, 0,8 kg)</b>   |                 |     |      |        |      |        |           |
| 42 427 27  | 020281.5L11.303 | 26  | 2150 | 83     | 3000 | 90     | 0 ... +35 |
| 42 427 28  | 020283.5L11.303 | 26  | 2150 | 83     | 3000 | 90     | 0 ... +35 |
| 42 427 29  | 020281.5L12.302 | 26  | 2400 | 92     | 4000 | 90     | 0 ... +35 |
| 42 427 30  | 020283.5L12.302 | 26  | 2400 | 92     | 4000 | 90     | 0 ... +35 |
| <b>STANDARD (L170/185/207 W63/74/87 H118/135/147 mm, 0,4 kg / 0,6 kg / 0,8 kg)</b> |                 |     |      |        |      |        |           |
|  | 02028X.5L01.10X | 10  | 950  | 95     | 3000 | 80     | 0 ... +35 |
|  | 02028X.5L02.10X | 10  | 1000 | 100    | 4000 | 80     | 0 ... +35 |
|  | 02028X.5L03.20X | 19  | 2000 | 105    | 3000 | 80     | 0 ... +35 |
|  | 02028X.5L04.20X | 19  | 2100 | 111    | 4000 | 80     | 0 ... +35 |
|  | 02028X.5L05.30X | 26  | 2700 | 104    | 3000 | 80     | 0 ... +35 |
|  | 02028X.5L06.30X | 26  | 2850 | 110    | 4000 | 80     | 0 ... +35 |

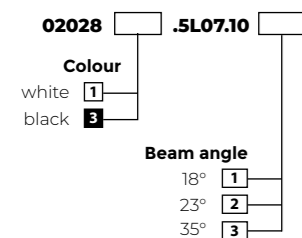

**Also available in following colours**  
 ■ Graphite (RAL 7016)  
 ■ Grey (RAL 7035)

**OTHER PICTURES**



**DIMENSIONAL DRAWING**

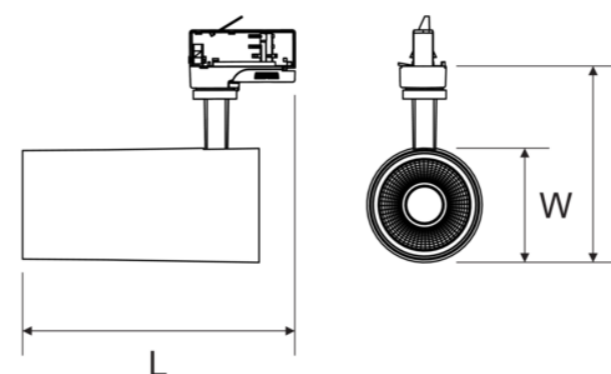

**LIGHT BEAM CURVES**

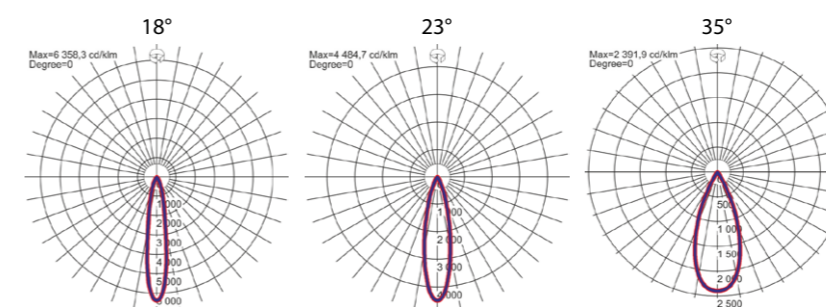



Sonic Arm spotlights with arm mount, cast aluminium for outdoor or indoor use. Excellent as signage or façade lights. Sonic Arm comes in two sizes, Mini comes with fixed 13W LED module. Medium has fixed 38W LED module. All variants have a luminaire head that can be twisted and angled, with a symmetrical slide. Variants have the possibility to switch reflectors for other beam angles. The Sonic series is specially treated for outdoor use. Material: Die-cast aluminium. Class I – IP65.

Also available in 4000K colour temperature.

- TECHNICAL DATA** Mounting: wall  
Body: high pressure die-cast aluminium  
Colour: graphite
- ELECTRICAL DATA** Includes light source: YES  
Power: 230V 50-60Hz  
Type of equipment: ON/OFF
- OPTICAL DATA** Light distribution: symmetric  
Way of lighting: direct
- GENERAL DATA** Lifetime (L70B10): 50 000 h  
SDCM: 3  
Warranty: 5 years



| Electrical number | Code            | (IP) | (W) | (Lm) | (lm/W) | Beam angle | (K)  | CRI |
|-------------------|-----------------|------|-----|------|--------|------------|------|-----|
| <b>Sonic Arm</b>  |                 |      |     |      |        |            |      |     |
| 45 174 13         | 5932-7-3-901-02 | 65   | 13  | 1380 | 106    | 42°        | 3000 | 80  |
| 45 154 31         | 3109454         | 65   | 13  | 1350 | 104    | 25°        | 3000 | 80  |
| 45 154 32         | 3109456         | 65   | 38  | 3575 | 94     | 19°        | 3000 | 80  |
| 45 154 63         | 3109457         | 65   | 38  | 3575 | 94     | 43°        | 3000 | 80  |

Also available in following colours

- Black (RAL 9005)
- Graphite (RAL 7016)
- Dark Grey (RAL 7037)
- Aluminium Silver (RAL 9006)
- White (RAL 9010)

OTHER PICTURES



DIMENSIONAL DRAWING

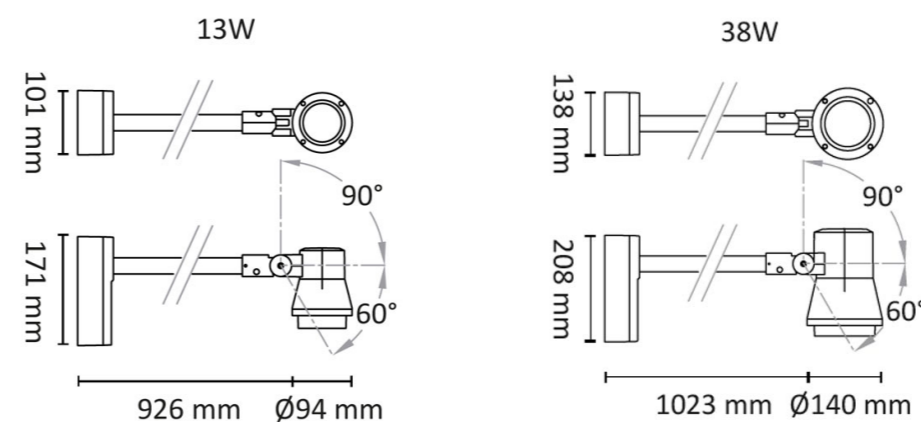

LIGHT BEAM CURVES

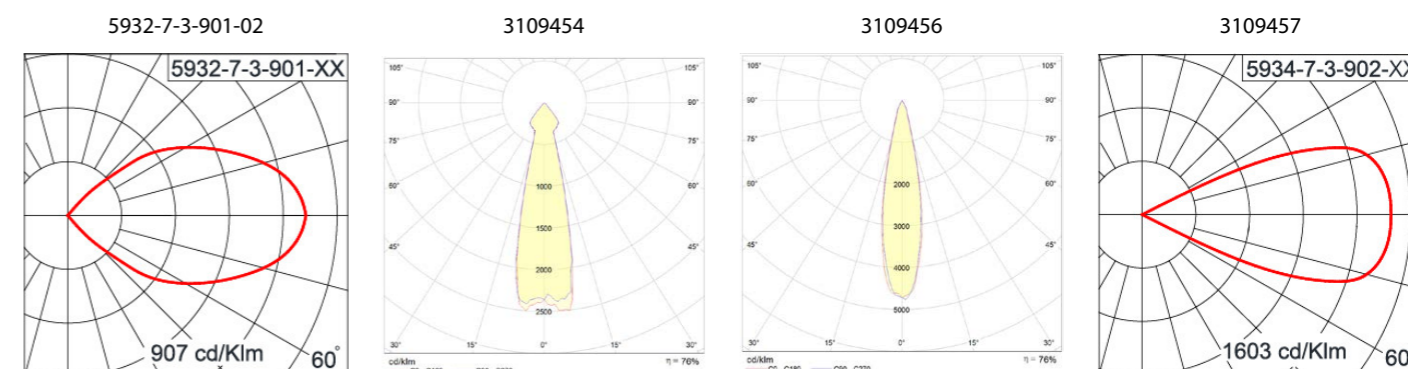



Sleeper is a bed-head wall lamp with flexible arm and integrated 4W LED. A perfect reading light next to the bed. Concentrated shielded light which not disturb others. The Sleeper is dimmable with integrated touch dimmer. The light color is 3000K.

- TECHNICAL DATA** Mounting: wall
- Body:** aluminium
- Colour:** black, white
- ELECTRICAL DATA** Includes light source: YES
- Power:** 230V 50-60Hz
- Type of equipment:** dimmable
- OPTICAL DATA** Light distribution: symmetric
- Way of lighting:** direct
- GENERAL DATA** Lifetime (L70B10): 50 000 h
- SDCM:** 3
- Warranty:** 5 years



| Electrical number | Code    | (IP) | (W) | (Lm) | (lm/W) | (K)  | CRI | Colour | Width/height/depth (mm) |
|-------------------|---------|------|-----|------|--------|------|-----|--------|-------------------------|
| <b>Sleeper</b>    |         |      |     |      |        |      |     |        |                         |
| 41 263 00         | 3235775 | 20   | 4   | 200  | 50     | 3000 | 80  | Black  | 50/100/430              |
| 41 263 01         | 3235776 | 20   | 4   | 200  | 50     | 3000 | 80  | White  | 50/100/430              |

OTHER PICTURES



DIMENSIONAL DRAWING

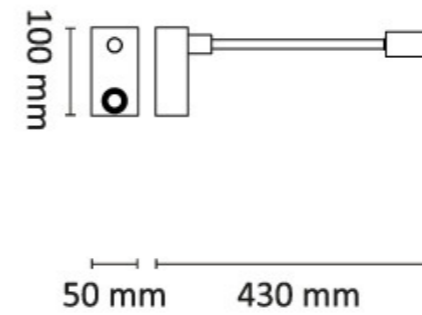

Plafond is a high quality indoor luminaire for wall or ceiling mounting. Product family consists of 3 different sizes and both ON/OFF and Radar versions. Plafond is mainly used in corridors, staircases and public facilities.

- TECHNICAL DATA** **Mounting:** surface mounting
- Body:** polycarbonate
- Colour:** white
- Diffuser:** opal
- ELECTRICAL DATA** **Includes light source:** YES
- Type of equipment:** ON/OFF, Radar
- Electrical connection:** ON/OFF 3x2,5mm<sup>2</sup>, radar 4x2,5mm<sup>2</sup>
- OPTICAL DATA** **Light distribution:** symmetric
- Way of lighting:** direct
- GENERAL DATA** **Lifetime (L70B50):** 50 000 h
- SDCM:** 6
- Warranty:** 5 years



| Electrical number                  | (W) | (Lm)      | (lm/W)  | (K)       | (IP) | (IK) | CRI/Ra | (°C)       | Diameter/height |
|------------------------------------|-----|-----------|---------|-----------|------|------|--------|------------|-----------------|
| <b>Plafond (0,43 kg / 0,73 kg)</b> |     |           |         |           |      |      |        |            |                 |
| 41 620 14                          | 9   | 700/750   | 78/83   | 3000/4000 | 44   | 10   | 80     | 0...+25 °C | 260/70          |
| 41 620 15                          | 12  | 1050/1100 | 88/92   | 3000/4000 | 44   | 10   | 80     | 0...+25 °C | 350/76          |
| 41 620 16                          | 12  | 1050/1100 | 88/92   | 3000/4000 | 44   | 10   | 80     | 0...+25 °C | 350/76          |
| <b>Plafond radar (1,1 kg)</b>      |     |           |         |           |      |      |        |            |                 |
| 41 620 17                          | 18  | 1800/1900 | 100/106 | 3000/4000 | 44   | 10   | 80     | 0...+25 °C | 400/95          |
| 41 620 18                          | 18  | 1800/1900 | 100/106 | 3000/4000 | 44   | 10   | 80     | 0...+25 °C | 400/95          |

**OTHER PICTURES**



**DIMENSIONAL DRAWING**

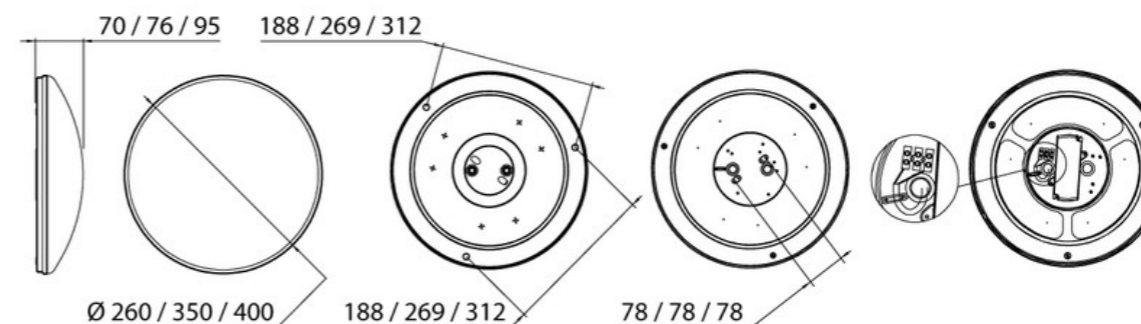

**LIGHT BEAM CURVES**

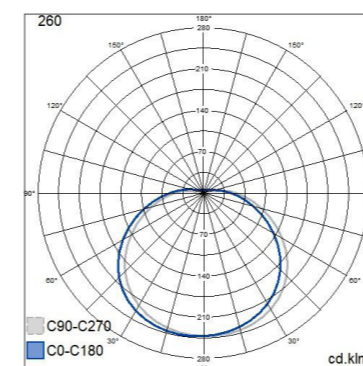

IP54 slim LED circular bulkhead, colour selectable with optional micro-wave sensor fitted internally

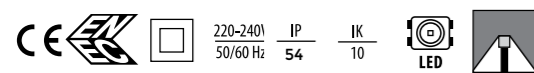

**CONSTRUCTION** **Mounting:** for surface mounting, wall or ceiling  
**Body:** polycarbonate, white RAL9016  
**Diffuser:** opal polycarbonate

**TECHNICAL DATA** **Driver:** integral, included  
**Dimming:** MW sensor has corridor dimming function 20-100%  
**Power factor:** >0.95  
**Sensor:** optional micro-wave sensor fitted under diffuser

**GENERAL DATA** **Electrical connection:** terminal block, 2 x 2 x 1.5mm<sup>2</sup>  
**Application:** corridors, toilets & changing rooms  
**Operating temperature:** -20°C - +25°C  
**Lumen depreciation:** L70: B50: 100,000 hours  
**SDCM:** <3  
**Warranty:** 5 years



| Electrical number | Code                    | W  | lm   | lm/W | K               | CRI/Ra | Sensor |
|-------------------|-------------------------|----|------|------|-----------------|--------|--------|
| <b>Rockford</b>   |                         |    |      |      |                 |        |        |
| 42 665 31         | BB/NRK12/830-840-857    | 12 | 1710 | 144  | 3000/4000/5700K | ≥80    | No     |
| 42 665 32         | BB/NRK12/MW/830-840-857 | 12 | 1710 | 144  | 3000/4000/5700K | ≥80    | Yes    |

**OTHER PICTURES**



ROCKFORD CCT switch



ROCKFORD back

**DIMENSIONAL DRAWING**

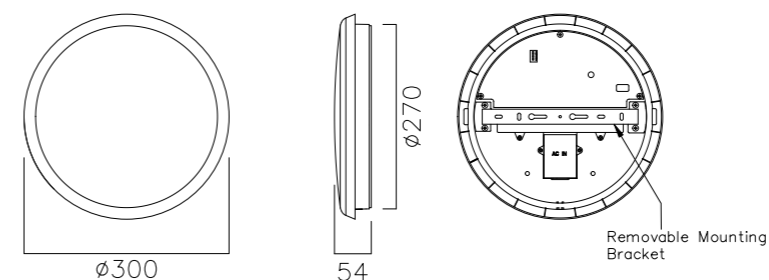

**LIGHT BEAM CURVES**

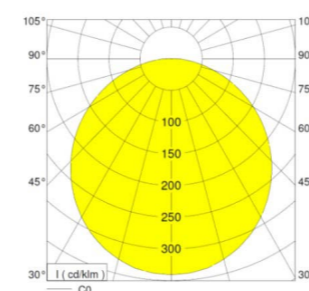

ROCKFORD 12W

Workpoint is planned mainly for kitchen and utility room worktops. Before installing colourtemperature can be chosen between 3000K and 4000K. It can be installed to a surface or 45 degree angle.

- TECHNICAL DATA** **Mounting:** surface mounting
- Body:** aluminium
- Colour:** white
- Diffuser:** opal
- ELECTRICAL DATA** **Includes light source:** YES
- Type of equipment:** ON/OFF
- Electrical connection:** 4x2,5mm<sup>2</sup>
- OPTICAL DATA** **Light distribution:** symmetric
- Way of lighting:** direct
- GENERAL DATA** **Lifetime (L70B50):** 50 000 h
- SDCM:** 5
- Warranty:** 5 years



| Electrical number                    | (IP) | (W) | (Lm) | (lm/W) | (K)       | CRI/Ra | (°C)        | Measurements L/W/H (mm) |
|--------------------------------------|------|-----|------|--------|-----------|--------|-------------|-------------------------|
| <b>Workpoint (0,46 kg / 0,65 kg)</b> |      |     |      |        |           |        |             |                         |
| 41 620 19                            | 44   | 8   | 850  | 106    | 3000/4000 | 80     | +5...+25 °C | 550/74/44               |
| 41 620 20                            | 44   | 11  | 1000 | 91     | 3000/4000 | 80     | +5...+25 °C | 750/74/44               |

OTHER PICTURES



DIMENSIONAL DRAWING

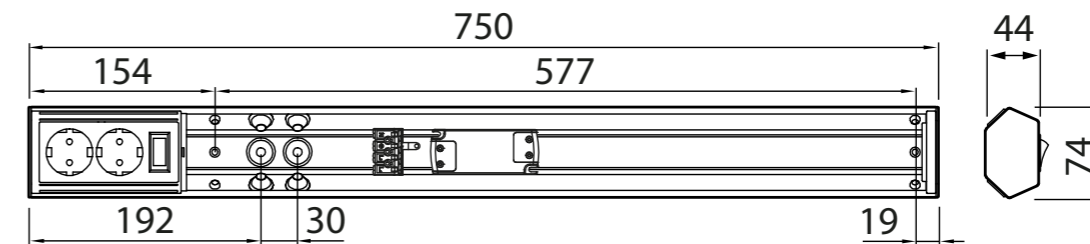
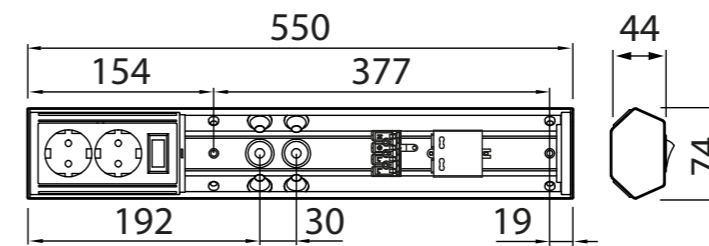

Nice Eco is a classic bathroom luminaire. The LED chips are spread on a separate interchangeable module that can be easily disassembled with simple locks and quick coupling. This provides easy installation and easy service in case of later replacement.

Nice Eco comes in two different models, with outlet (separate connections) or with PIR sensor (6 meter detection range and 10 mins delayed shut down).

- TECHNICAL DATA**  
Mounting: wall, surface  
Body: polycarbonate  
Colour: white  
Diffuser: opal
- ELECTRICAL DATA**  
Includes light source: YES  
Power: 230V 50-60Hz  
Type of equipment: ON/OFF, PIR
- OPTICAL DATA**  
Light distribution: symmetric  
Way of lighting: direct
- GENERAL DATA**  
Lifetime (L70B10): 50 000 h  
SDCM: 3  
Warranty: 5 years



| Electrical number | Code    | Sockets | (IP) | (W) | (Lm) | (lm/W) | (K)  | CRI/Ra | Length/height/Depth (mm) |
|-------------------|---------|---------|------|-----|------|--------|------|--------|--------------------------|
| <b>ON/OFF</b>     |         |         |      |     |      |        |      |        |                          |
|                   | 3305895 | 2       | 44   | 7   | 550  | 79     | 3000 | 80     | 678/60/81                |
| 41 015 12         | 3305896 | 1       | 44   | 7   | 550  | 79     | 3000 | 80     | 588/60/81                |
| <b>PIR</b>        |         |         |      |     |      |        |      |        |                          |
| 41 015 13         | 3305897 | 0       | 44   | 7   | 550  | 79     | 3000 | 80     | 588/60/90                |

**OTHER PICTURES**

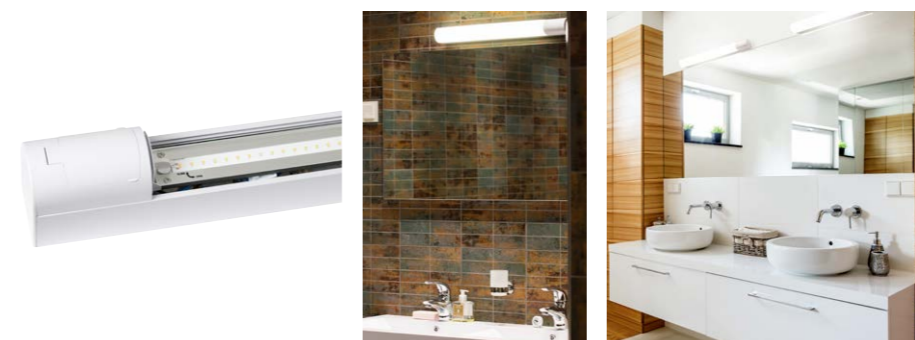

**DIMENSIONAL DRAWING**

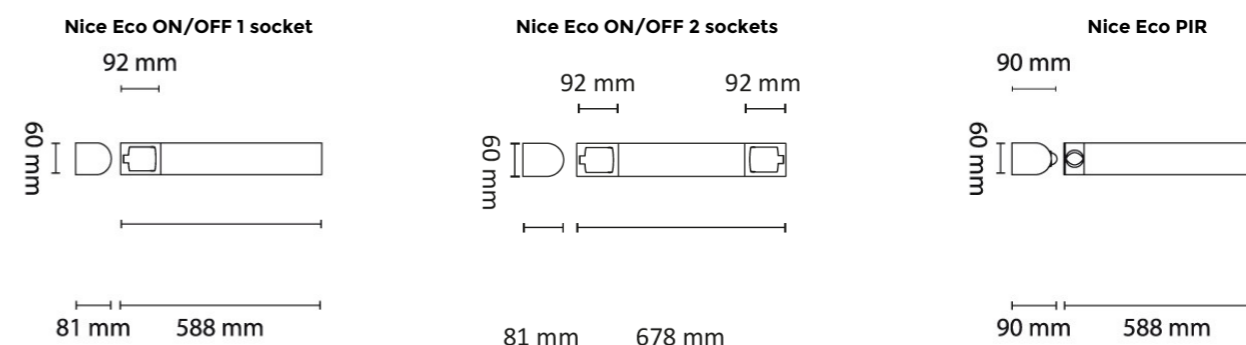

**LIGHT BEAM CURVES**

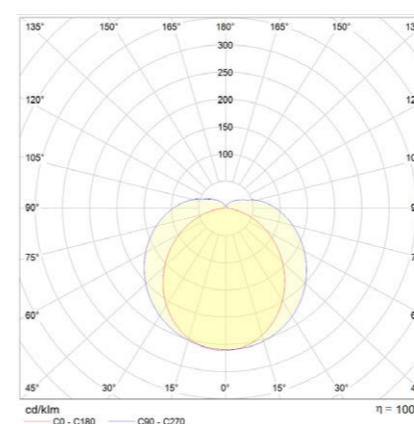



**STRIP**  
(page 96)



**POWERSTRIP**  
(page 100)



High-quality LED light strip suitable for professional use.

The LED light strip with adhesive tape is suitable and designed for indoor and outdoor installations. Easy to install and mainly used in decks, terraces, railings, staircases and bathrooms. The 3m supply wires at both ends of the LED strip makes installation easier.

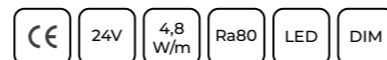

The Strip Driver is a dimmable power supply with a TRIAC controller. Also suitable for renovation projects with a two-conductor system.

With the aluminum profile, you complete the installation and the profile also acts as a cooling surface for the most efficient LED light strips. The profile comes with an opal protection strip, 4 end pieces and 4 fasteners. The profile can be cut into two parts, so that the brackets for both profiles can be found in the package.

| Electrical number                   | Code          | (IP) | (W)    | (Lm)       | (lm/W)  | (K)   | CRI/Ra | (°C)         |
|-------------------------------------|---------------|------|--------|------------|---------|-------|--------|--------------|
| <b>Strip IP20 (L8 H2 mm, 5m)</b>    |               |      |        |            |         |       |        |              |
| 41 620 01                           | 6438524000024 | IP20 | 4,8W/m | 350 lm / m | 72,9 lm | 3000K | Ra80   | -20...+50 °C |
| 41 620 00                           | 6438524000017 | IP20 | 4,8W/m | 380 lm / m | 79,1 lm | 4000K | Ra80   | -20...+50 °C |
| <b>Strip IP67 (L10 H4,8 mm, 5m)</b> |               |      |        |            |         |       |        |              |
| 41 620 03                           | 6438524000048 | IP67 | 4,8W/m | 350 lm / m | 72,9 lm | 3000K | Ra80   | -20...+50 °C |
| 41 620 02                           | 6438524000031 | IP67 | 4,8W/m | 380 lm / m | 79,1 lm | 4000K | Ra80   | -20...+50 °C |

OTHER PICTURES

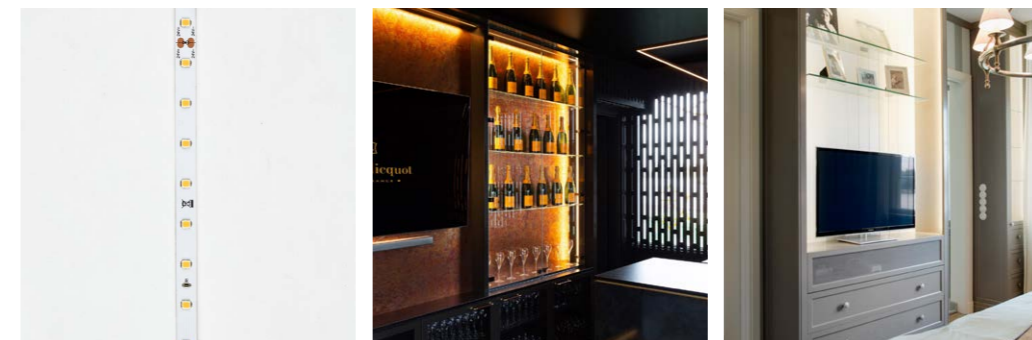

DIMENSIONAL DRAWING

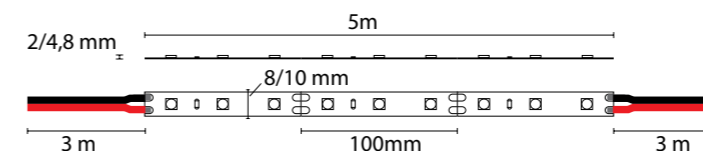

ACCESSORIES



Strip Driver 25W 24V Dim  
**40 993 01**



Strip Driver 36W 24V on-off  
**40 993 03**



Strip Profile 16x16x2500 Angle  
**41 620 10**



Strip Profile 16x06x2500 Recess  
**41 620 11**



Strip Profile 16x07x2500 Surface  
**41 620 12**

UltraStrip is a premium high-quality and efficient LED light strip that is especially suitable for general lighting. The LED light strip must be mounted on an aluminum profile that cools it and thus remains long-lasting. 3-meter supply wires at both ends of the LED strip makes installation easier.

The Strip Driver is a dimmable power supply with a TRIAC controller. Also suitable for renovation projects with a two-conductor system.

With the aluminum profile, you complete the installation and the profile also acts as a cooling surface for the most efficient LED light strips. The profile comes with an opal protection strip, 4 end pieces and 4 fasteners. The profile can be cut into two parts, so that the brackets for both profiles can be found in the package.

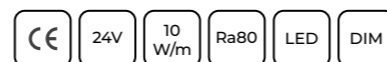

| Electrical number                         | Code          | (IP) | (W)   | (Lm)        | (lm/W) | (K)    | CRI/Ra | (°C)         |
|---|---------------|------|-------|-------------|--------|--------|--------|--------------|
| <b>UltraStrip IP20 (L8 H2 mm, 5 m)</b>    |               |      |       |             |        |        |        |              |
| 41 620 05                                 | 6438524000062 | IP20 | 10W/m | 1150 lm / m | 115 lm | 3000 K | Ra80   | -20...+50 °C |
| 41 620 04                                 | 6438524000055 | IP20 | 10W/m | 1180 lm / m | 118 lm | 4000 K | Ra80   | -20...+50 °C |
| <b>UltraStrip IP67 (L10 H4,8 mm, 5 m)</b> |               |      |       |             |        |        |        |              |
| 41 620 07                                 | 6438524000086 | IP67 | 10W/m | 1150 lm / m | 115 lm | 3000 K | Ra80   | -20...+50 °C |
| 41 620 06                                 | 6438524000079 | IP67 | 10W/m | 1180 lm / m | 118 lm | 4000 K | Ra80   | -20...+50 °C |

**OTHER PICTURES**

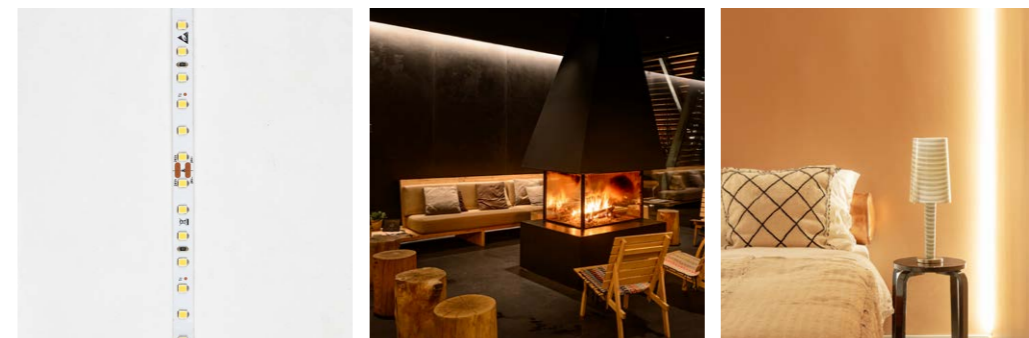

**DIMENSIONAL DRAWING**

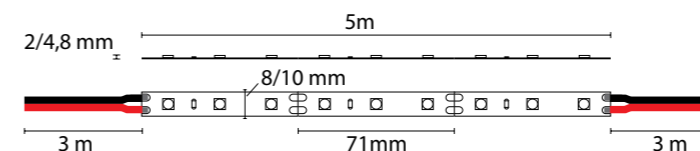

**ACCESSORIES**



The PowerStrip is an LED light strip with excellent efficiency, which is well suited for kitchen spaces, for example. 3-meter supply wires at both ends of the LED strip makes installation easier.

The Strip Driver is a dimmable power supply with a TRIAC controller. Also suitable for renovation projects with a two-conductor system.

With the aluminum profile, you complete the installation and the profile also acts as a cooling surface for the most efficient LED light strips. The profile comes with an opal protection strip, 4 end pieces and 4 fasteners. The profile can be cut into two parts, so that the brackets for both profiles can be found in the package.

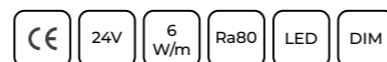

| Electrical number                    | Code          | (IP) | (W)  | (Lm)       | (lm/W) | (K)    | CRI/Ra | (°C)         |
|--------------------------------------|---------------|------|------|------------|--------|--------|--------|--------------|
| <b>PowerStrip 3K (L8 H2 mm, 5 m)</b> |               |      |      |            |        |        |        |              |
| 41 620 09                            | 6438524000109 | IP20 | 6W/m | 830 lm / m | 138 lm | 3000 K | Ra80   | -20...+50 °C |
| <b>PowerStrip 4K (L8 H2 mm, 5 m)</b> |               |      |      |            |        |        |        |              |
| 41 620 08                            | 6438524000093 | IP20 | 6W/m | 850 lm / m | 141 lm | 4000 K | Ra80   | -20...+50 °C |

**OTHER PICTURES**



**DIMENSIONAL DRAWING**

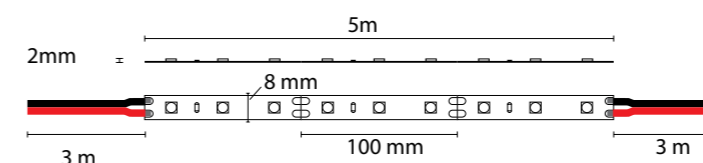

**ACCESSORIES**



Strip Driver 50W 24V Dim  
**40 993 02**



Strip Driver 36W 24V on-off  
**40 993 03**



Strip Profile 16x16x2500 Angle  
**41 620 10**



Strip Profile 16x06x2500 Recess  
**41 620 11**



Strip Profile 16x07x2500 Surface  
**41 620 12**



**ULTRASTRIP**  
(page 98)

Fiber is a high-quality premium fiber light series for sauna ceilings and benches. The fiber light set has a 10W LED projector suitable for retrofitting with dimming. Includes a heater lens.

CE 10W LED DIM IP54

**Fibre Length**  
2 x 2,5m / 1,5mm  
3 x 3,0m / 1,5mm  
2 x 3,5m / 1,5mm  
1 x 4,0m / 3,0mm + lens for stove fiber



OTHER PICTURES

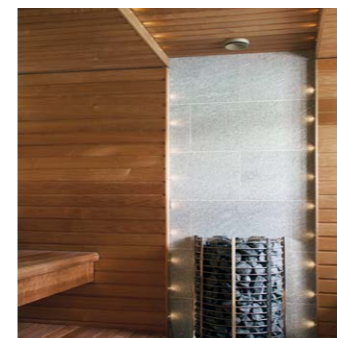

| Electrical number  | Code          | (IP) | (W) | (K)    | (°C)          |
|--------------------|---------------|------|-----|--------|---------------|
| <b>Strip Fibre</b> |               |      |     |        |               |
| 41 620 13          | 6438524000161 | IP55 | 10W | 3000 K | -30...+180 °C |

DIMENSIONAL DRAWING

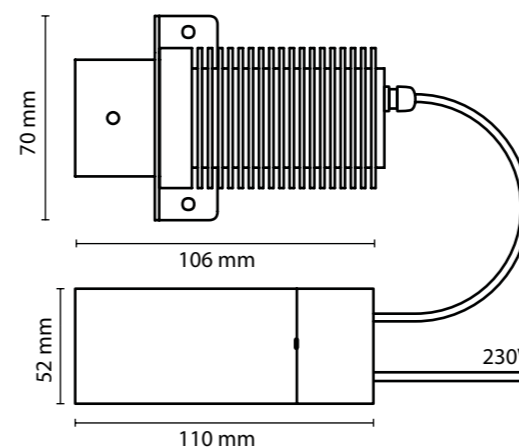

Modern recessed luminaire for modular suspended ceilings for LED light sources.



- TECHNICAL DATA**  
**Mounting:** directly in the ceiling construction  
**Body:** powder-painted steel sheet  
**Colour:** white  
**Diffuser:** lamella and glass/opal plexiglass (PLX)
- ELECTRICAL DATA**  
**Power supply efficiency:** >90%  
**Power:** 220-240V 50/60Hz  
**Includes light source:** yes  
**Type of equipment:** ON/OFF, DALI  
**Electrical connection:** luminaire equipped with 3x1 mm<sup>2</sup> wire with a length of 80 cm
- OPTICAL DATA**  
**Light distribution:** symmetric  
**Way of lighting:** direct  
**Louver:** aluminum mat
- GENERAL DATA**  
**Lifetime (L80B10):** 50 000 h  
**Operating temperature range:** 0°C ... +35°C  
**SDCM:** 3  
**Warranty:** 5 years  
**Application:** hospitals, laboratories, clinics

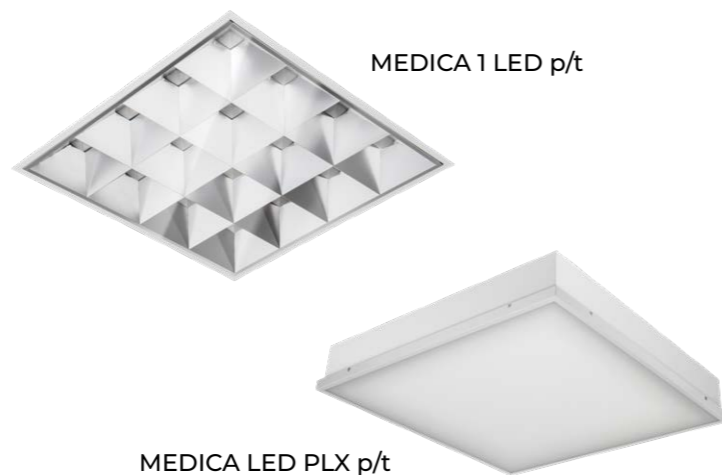

MEDICA LED PLX p/t

| Electrical number                                     | Code            | (W) | (Lm) | (lm/W) | (K)  | CRI/Ra |
|---|-----------------|-----|------|--------|------|--------|
| <b>MEDICA 1 LED p/t (L595 W595 H110 mm, 8,0 kg)</b>   |                 |     |      |        |      |        |
| 42 459 09   | 070101.5L02.312 | 39  | 3900 | 100    | 4000 | ≥80    |
| 42 459 10   | 070101.5L04.312 | 58  | 5450 | 94     | 4000 | ≥80    |
| <b>MEDICA LED PLX p/t (L595 W595 H110 mm, 8,0 kg)</b> |                 |     |      |        |      |        |
| 42 459 05   | 070111.5L02.311 | 43  | 4700 | 109    | 4000 | ≥80    |
| 42 459 06   | 070111.5L04.311 | 71  | 9050 | 127    | 4000 | ≥80    |

OTHER PICTURES



Medica 1 LED p/t

LIGHT BEAM CURVES

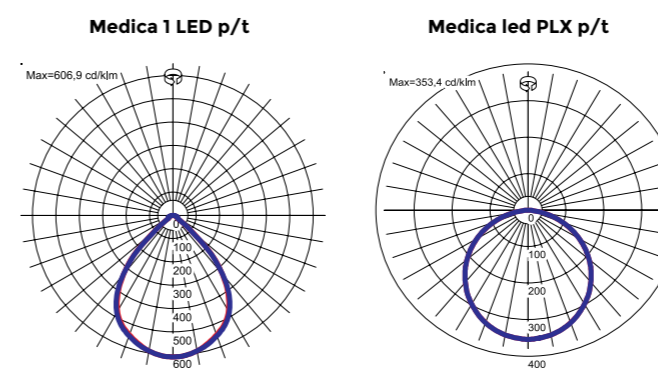

DIMENSIONAL DRAWING

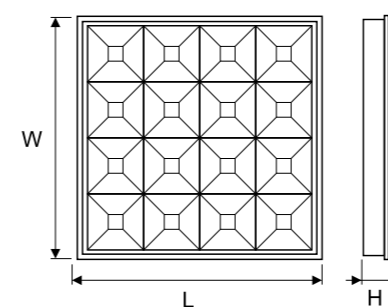

PROJECTS



LHL Hospital  
Oslo, Norway

Specialized bactericidal and virucidal luminaire with T8 light sources (included).  
Surface mounted luminaire, emitting UV-C radiation with a wavelength of 253.7 nm.

- TECHNICAL DATA** **Mounting:** directly in the ceiling construction  
**Body:** powder-painted steel sheet  
**Colour:** white  
**Diffuser:** glass
- ELECTRICAL DATA** **Power supply efficiency:** >90%  
**Power:** 220-240V 50/60Hz  
**Includes light source:** yes  
**Type of equipment:** ON/OFF
- OPTICAL DATA** **Electrical connection:** luminaire equipped with 3x1 mm<sup>2</sup> wire with a length of 80 cm  
**Light distribution:** symmetric  
**Way of lighting:** direct  
**Louver:** aluminum mat
- GENERAL DATA** **Lifetime (L80B10):** 50 000 h  
**Operating temperature range:** 0°C ... +35°C  
**Warranty:** 5 years  
**Application:** hospitals, laboratories, clinics

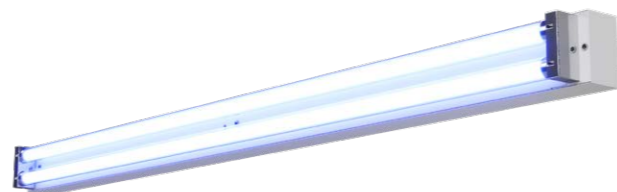
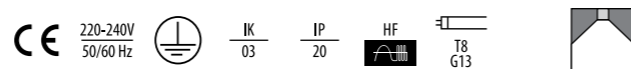

| Electrical number   | Code | Number of UV-C lamps | Type of radiant tube (W) | Luminaire power (W) | Decontamination area (m <sup>2</sup> )* max. | Decontamination time (hh:mm) | (h)  |
|---|------|----------------------|--------------------------|---------------------|--|------------------------------|------|
| <b>With light source operating time counter (L940/1250 W50 H88 mm, 1,7 kg / 2,4 kg)</b>                             |      |                      |                          |                     |  |                              |      |
| 170011.1021.201   |      | 1                    | 30                       | 33                  | 12   | 3:10                         | 8000 |
| 170011.1031.201   |      | 1                    | 36                       | 40                  | 15   | 2:43                         | 8000 |
| 170011.1051.201   |      | 2                    | 30                       | 66                  | 18   | 3:02                         | 8000 |
| 170011.1061.201   |      | 2                    | 36                       | 79                  | 22   | 2:33                         | 8000 |
| <b>With light source operating time counter and remote control (L940/1250 W50 H88 mm, 1,7 kg / 2,1 kg / 2,4 kg)</b> |      |                      |                          |                     |  |                              |      |
| 170011.1021.203   |      | 1                    | 30                       | 35                  | 12   | 3:10                         | 8000 |
| 170011.1031.203   |      | 1                    | 36                       | 41                  | 15   | 2:43                         | 8000 |
| 170011.1051.203   |      | 2                    | 30                       | 68                  | 18   | 3:02                         | 8000 |
| 170011.1061.203   |      | 2                    | 36                       | 81                  | 22   | 2:33                         | 8000 |
| <b>Standard (L940/1250 W50 H88 mm, 1,6 kg / 2,0 kg / 2,3 kg)</b>  |      |                      |                          |                     |  |                              |      |
| 170011.1021.200   |      | 1                    | 30                       | 33                  | 12   | 3:10                         | 8000 |
| 170011.1031.200   |      | 1                    | 36                       | 40                  | 15   | 2:43                         | 8000 |
| 170011.1051.200   |      | 2                    | 30                       | 66                  | 18   | 3:02                         | 8000 |
| 170011.1061.200   |      | 2                    | 36                       | 79                  | 22   | 2:33                         | 8000 |

Also available in following colours

- Black (RAL 9005)
- Grey (RAL 7035)

**OTHER PICTURES**



**LIGHT BEAM CURVES**

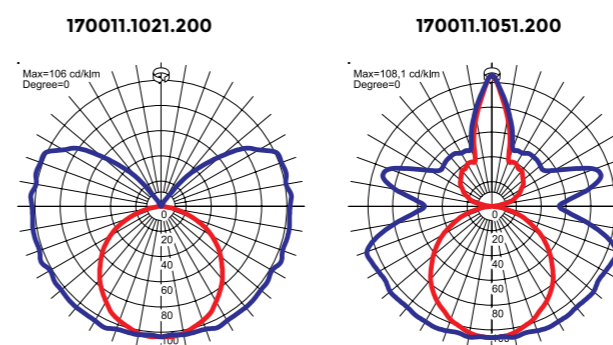

**DIMENSIONAL DRAWING**

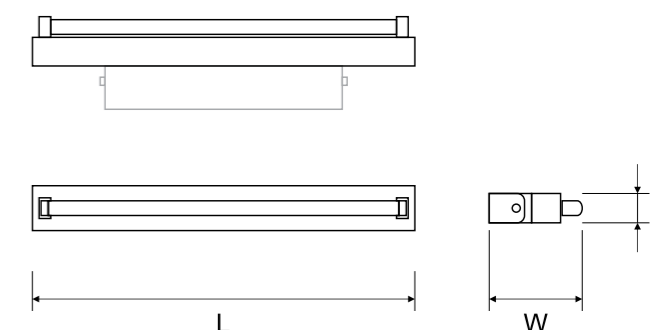

**ACCESSORIES**

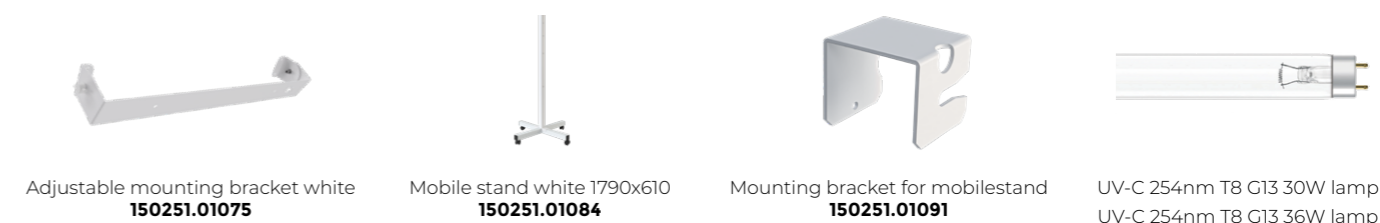

- Protective grille 1x900 white **150251.01085**
- Protective grille 1x1200 white **150251.01086**
- Protective grille 2x900 white **150251.01098**
- Protective grille 2x1200 white **150251.01099**

Specialized bactericidal and virucidal luminaire with T8 light sources (included).  
Surface mounted luminaire, emitting UV-C radiation with a wavelength of 253.7 nm.

**TECHNICAL DATA** **Mounting:** surface mounted  
**Body:** powder-painted steel sheet; reflector: aluminum  
**Colour:** white

**ELECTRICAL DATA** **Power supply efficiency:** >90%  
**Power:** 220-240V 50/60Hz  
**Includes light source:** yes  
**Type of equipment:** remote control  
**Electrical connection:** max 3x1,5 mm<sup>2</sup> wire  
**Light distribution:** asymmetric, symmetric  
**Way of lighting:** direct  
**Type of optic:** reflector  
**Reflector:** aluminum polished

**OPTICAL DATA**

**GENERAL DATA** **Operating temperature range:** 0 °C ... +35 °C  
**Additional information:** \*maximum decontamination area for 90%; up to 99% - the exposure time should be extended 2 times; at 99.9% - the exposure time should be extended 3 times  
**Other remarks:** recommended mounting height of the luminaire from 2.1 m to 2.5 m.  
**Warranty:** 2 years  
**Application:** hospitals, laboratories, clinics, pharmacy, pharmaceutical and cosmetics industry, hotels, schools, kindergartens, nurseries, service companies, production facilities, means of transport

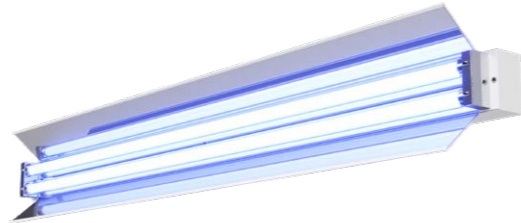
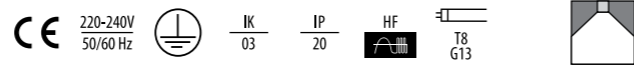

**OTHER PICTURES**



**LIGHT BEAM CURVES**

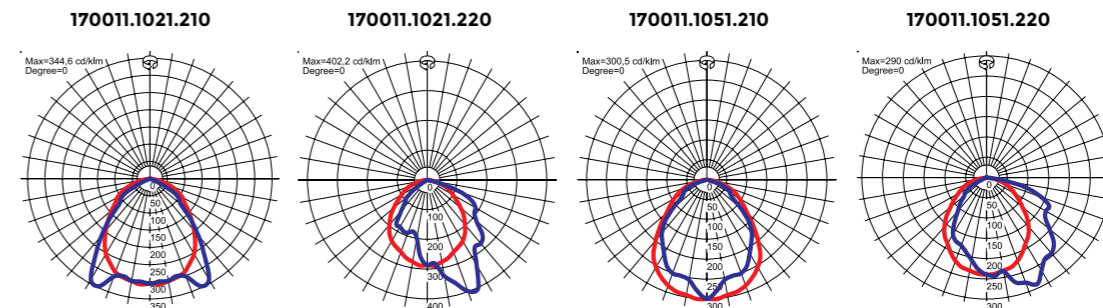

| Electrical number  | Code            | Number of UV-C lamps | Type of radiant tube (W) | Luminaire power (W) | Decontamination area (m <sup>2</sup> )* max. | Decontamination time (hh:mm) | (h)  |
|--|-----------------|----------------------|--------------------------|---------------------|--|------------------------------|------|
| <b>ASYMMETRICAL with light source operating time counter (L0/W0/H0 mm, 0,0 kg)</b> |                 |                      |                          |                     |  |                              |      |
|  | 170011.1021.221 | 1                    | 30                       | 33                  | 12   | 0:59                         | 8000 |
|  | 170011.1031.221 | 1                    | 36                       | 40                  | 15   | 0:51                         | 8000 |
|  | 170011.1051.221 | 2                    | 30                       | 66                  | 18   | 0:56                         | 8000 |
|  | 170011.1061.221 | 2                    | 36                       | 79                  | 22   | 0:47                         | 8000 |
| <b>ASYMMETRICAL (L0/W0/H0 mm, 0,0 kg)</b>  |                 |                      |                          |                     |  |                              |      |
|  | 170011.1021.220 | 1                    | 30                       | 33                  | 12   | 00:59                        | 8000 |
|  | 170011.1031.220 | 1                    | 36                       | 40                  | 15   | 00:51                        | 8000 |
|  | 170011.1051.220 | 2                    | 30                       | 66                  | 18   | 00:56                        | 8000 |
|  | 170011.1061.220 | 2                    | 36                       | 79                  | 22   | 00:47                        | 8000 |
| <b>SYMMETRICAL with light source operating time counter (L0/W0/H0 mm, 0,0 kg)</b>  |                 |                      |                          |                     |  |                              |      |
|  | 170011.1021.211 | 1                    | 30                       | 33                  | 12   | 00:59                        | 8000 |
|  | 170011.1031.211 | 1                    | 36                       | 40                  | 15   | 00:51                        | 8000 |
|  | 170011.1051.211 | 2                    | 30                       | 66                  | 18   | 00:56                        | 8000 |
|  | 170011.1061.211 | 2                    | 36                       | 79                  | 22   | 00:47                        | 8000 |
| <b>SYMMETRICAL (L0/W0/H0 mm, 0,0 kg)</b>   |                 |                      |                          |                     |  |                              |      |
|  | 170011.1021.210 | 1                    | 30                       | 33                  | 12   | 00:59                        | 8000 |
|  | 170011.1031.210 | 1                    | 36                       | 40                  | 15   | 00:51                        | 8000 |
|  | 170011.1051.210 | 2                    | 30                       | 66                  | 18   | 00:56                        | 8000 |
|  | 170011.1061.210 | 2                    | 36                       | 79                  | 22   | 00:47                        | 8000 |

Also available in following colours

- Black (RAL 9005)
- Grey (RAL 7035)

**ACCESSORIES**

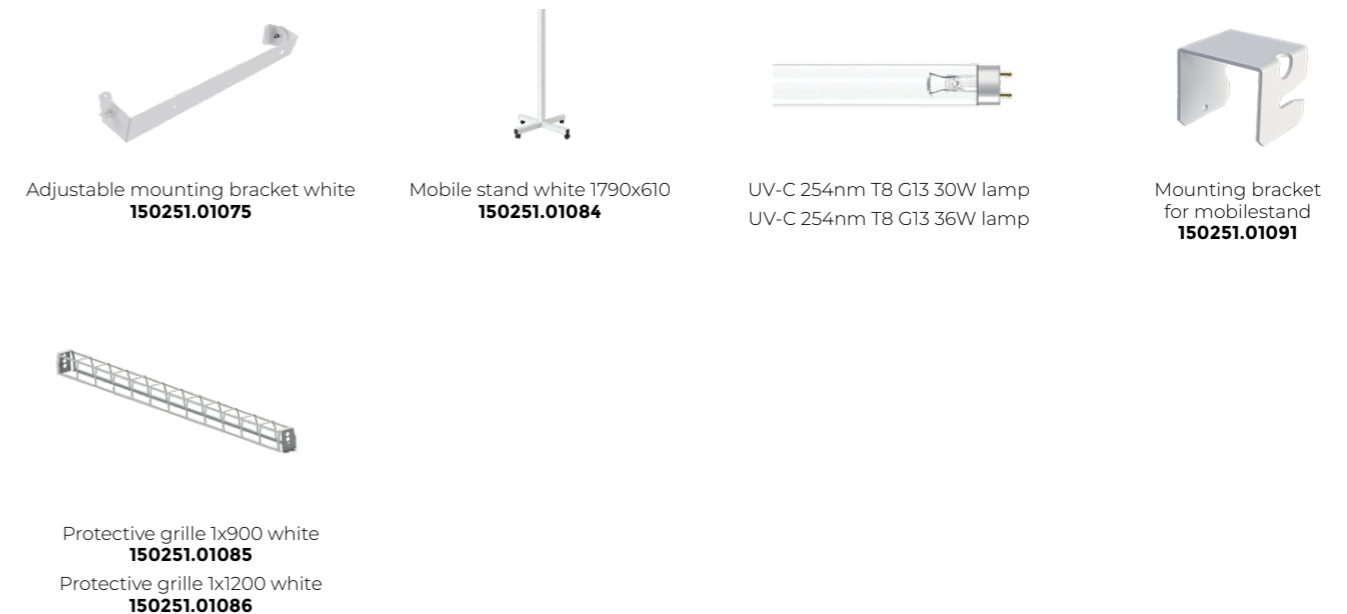

Protective grille 1x900 white  
**150251.01085**  
Protective grille 1x1200 white  
**150251.01086**





**CLEVELAND**  
(page 144)

**FARGO**  
(page 48)

The UV-C flow-through luminaire is a solution created for sterilization of rooms where people live. Specialized bactericidal and virucidal luminaire with T8 light sources (included). The luminaire can be surface-mounted or stand-mounted in a mobile version. It emits UV-C radiation at 253.7 nm. Forced air circulation and safe shielding of the emitted UV-C light ensure that the luminaire can be used in the presence of people indoors.

- TECHNICAL DATA** **Mounting:** surface mounted, with mounting brackets (included)  
**Body:** stainless steel sheet (inox), powder-coated steel sheet (white)  
**Colour:** inox, white
- ELECTRICAL DATA** **Power:** 220-240V 50/60Hz  
**Includes light source:** yes  
**Type of equipment:** remote control  
**Electrical connection:** 3-core 1.8 m long cord with UNISCHUKO connector
- OPTICAL DATA** **Way of lighting:** indirect
- GENERAL DATA** **Operating temperature range:** 0°C ... +35°C  
**Additional information:** recommended mounting height of the luminaire from 2.1 m to 2.5 m. Luminaire efficiency: 40m3/h  
**Other remarks:** \*maximum decontamination area for a room of 3m height; \*\*number of airflow cycles per day for a room of 3m height  
**Warranty:** 2 years  
**Application:** hospitals, laboratories, clinics, pharmacy, pharmaceutical and cosmetics industry, hotels, schools, kindergartens, nurseries, service companies, production facilities, means of transport



| Electrical number   | Code            | Colour | Number of UV-C lamps | Type of radiant tube (W) | Luminaire power (W) | Max. room volume (m³) | Decontamination area (m²)* max. | Number of airflow cycles per day** | (h)  |
|---|-----------------|--------|----------------------|--------------------------|---------------------|-----------------------|---------------------------------|------------------------------------|------|
| <b>With light source operating time counter (L1495/1795 W150 H100 D1:150, 12,5 kg / 12,6 kg / 15 kg / 15,2 kg)</b>  |                 |        |                      |                          |                     |                       |                                 |                                    |      |
| 42 427 43   | 170020.1021.610 | inox   | 2                    | 30                       | 68                  | 50                    | 17                              | 19                                 | 8000 |
| 42 427 44   | 170021.1021.610 | white  | 2                    | 30                       | 68                  | 50                    | 17                              | 19                                 | 8000 |
| 42 427 45   | 170020.1071.610 | inox   | 3                    | 30                       | 100                 | 75                    | 25                              | 13                                 | 8000 |
| 42 427 46   | 170021.1071.610 | white  | 3                    | 30                       | 100                 | 75                    | 25                              | 13                                 | 8000 |
| 42 427 47   | 170020.1051.610 | inox   | 2                    | 36                       | 76                  | 60                    | 20                              | 16                                 | 8000 |
| 42 427 48   | 170021.1051.610 | white  | 2                    | 36                       | 76                  | 60                    | 20                              | 16                                 | 8000 |
| 42 427 49   | 170020.1061.610 | inox   | 3                    | 36                       | 110                 | 90                    | 30                              | 11                                 | 8000 |
| 42 427 50   | 170021.1061.610 | white  | 3                    | 36                       | 110                 | 90                    | 30                              | 11                                 | 8000 |
| <b>With light source operating time counter and remote control (L1495/1795 W150 H100 D1:150, 12,6 kg - 16,2 kg)</b> |                 |        |                      |                          |                     |                       |                                 |                                    |      |
|   | 170020.1021.611 | inox   | 2                    | 30                       | 68                  | 50                    | 17                              | 19                                 | 8000 |
|   | 170021.1021.611 | white  | 2                    | 30                       | 68                  | 50                    | 17                              | 19                                 | 8000 |
|   | 170020.1071.611 | inox   | 3                    | 30                       | 100                 | 75                    | 25                              | 13                                 | 8000 |
|   | 170021.1071.611 | white  | 3                    | 30                       | 100                 | 75                    | 25                              | 13                                 | 8000 |
|   | 170020.1051.611 | inox   | 2                    | 36                       | 76                  | 60                    | 20                              | 16                                 | 8000 |
|   | 170021.1051.611 | white  | 2                    | 36                       | 76                  | 60                    | 20                              | 16                                 | 8000 |
|   | 170020.1061.611 | inox   | 3                    | 36                       | 110                 | 90                    | 30                              | 11                                 | 8000 |
|   | 170021.1061.611 | white  | 3                    | 36                       | 110                 | 90                    | 30                              | 11                                 | 8000 |

Also available in following colours  
 ■ Black (RAL 9005)  
 ■ Grey (RAL 7035)

OTHER PICTURES



DIMENSIONAL DRAWING

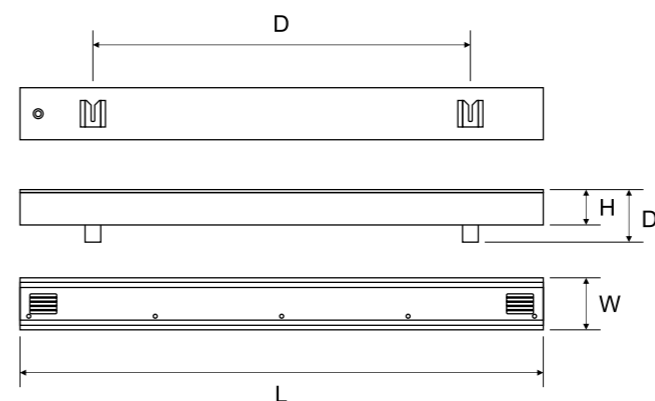

ACCESSORIES



Sponge filter 5 pcs  
150250.01108



Mobile stand white 1790x610  
150251.01084

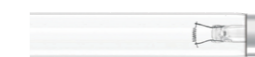

UV-C 254nm T8 G13 30W lamp  
UV-C 254nm T8 G13 36W lamp

The dual-function UV-C lamp is a solution designed to sterilize rooms and surfaces. The specialist bacterio- and virucidal luminaire with the T8 light source (included) has been designed for surface-mounting or stand-mounting in a mobile version. It emits UV-C radiation at 253.7 nm. Luminaire in FLOW mode thanks to the safe shielding of emitted UV-C light ensures that the luminaire can be used in the presence of people indoors. Additionally equipped with an external radiator enabling additional DIRECT function, i.e. decontamination of the surface after leaving the sterilized room by humans and animals.

- TECHNICAL DATA** **Mounting:** surface mounted, with mounting brackets (included)  
**Body:** stainless steel sheet (inox), powder-coated steel sheet (white)  
**Colour:** white, inox
- ELECTRICAL DATA** **Power:** 220-240V 50/60Hz  
**Includes light source:** yes  
**Type of equipment:** remote control  
**Electrical connection:** 3-core 1.8 m long cord with UNISCHUKO connector
- OPTICAL DATA** **Light distribution:** asymmetric  
**Way of lighting:** direct-indirect  
**Type of optic:** connection between closed and external radiant tube heater
- GENERAL DATA** **Operating temperature range:** 0 °C ... +35 °C  
**Available on request:** mobile stand  
**Additional information:** recommended mounting height of the luminaire from 2.1 m to 2.5 m. Luminaire efficiency: 40m3/h  
**Other remarks:** \*maximum decontamination area for a room of 3m height; \*\*number of airflow cycles per day for a room of 3m height  
**Warranty:** 2 years  
**Application:** hospitals, laboratories, clinics, pharmacy, pharmaceutical and cosmetics industry, hotels, schools, kindergartens, nurseries, service companies, production facilities, means of transport



**OTHER PICTURES**



**DIMENSIONAL DRAWING**

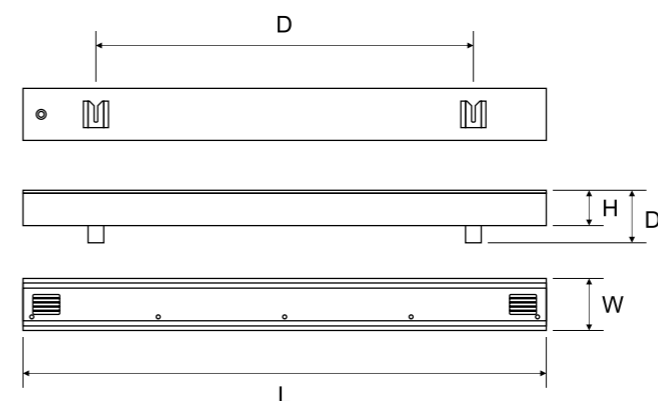

**ACCESSORIES**



Sponge filter 5 pcs  
**150250.01108**



Mobile stand white 1790x610  
**150251.01084**

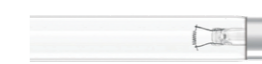

UV-C 254nm T8 G13 30W lamp  
UV-C 254nm T8 G13 36W lamp



Protective grille 1x900 white  
**150251.01085**  
Protective grille 1x1200 white  
**150251.01086**

| Electrical number   | Code | Colour | Number of UV-C lamps | Type of radiant tube (W) | Luminaire power (W) | Max. room volume (m³) | Decontamination area (m²)* max. | Number of airflow cycles per day** | (h)  |
|---|------|--------|----------------------|--------------------------|---------------------|-----------------------|---------------------------------|------------------------------------|------|
| <b>With light source operating time counter (L1495/1795 W210 H100 D1:210, 12,4 kg / 13,2 kg / 14 kg)</b>                    |      |        |                      |                          |                     |                       |                                 |                                    |      |
| 170031.1021.610   |      | white  | 3                    | 30                       | 102                 | 50                    | 17                              | 19                                 | 8000 |
| 170030.1021.610   |      | inox   | 3                    | 30                       | 102                 | 50                    | 17                              | 19                                 | 8000 |
| 170031.1071.610   |      | white  | 3                    | 36                       | 110                 | 60                    | 20                              | 16                                 | 8000 |
| 170030.1071.610   |      | inox   | 3                    | 36                       | 110                 | 60                    | 20                              | 16                                 | 8000 |
| <b>With light source operating time counter and remote control (L1495/1795 W210 H100 D1:210, 12,4 kg / 13,2 kg / 14 kg)</b> |      |        |                      |                          |                     |                       |                                 |                                    |      |
| 170031.1021.611   |      | white  | 3                    | 30                       | 102                 | 50                    | 17                              | 19                                 | 8000 |
| 170030.1021.611   |      | inox   | 3                    | 30                       | 102                 | 50                    | 17                              | 19                                 | 8000 |
| 170031.1071.611   |      | white  | 3                    | 36                       | 110                 | 60                    | 20                              | 16                                 | 8000 |
| 170030.1071.611   |      | inox   | 3                    | 36                       | 110                 | 60                    | 20                              | 16                                 | 8000 |

**Also available in following colours**

- Black (RAL 9005)
- Grey (RAL 7035)

**LIGHT BEAM CURVES**

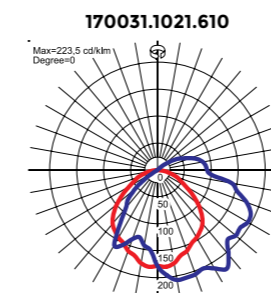



**ULTRASTRIP**  
(page 98)



**ULTRASTRIP**  
(page 98)

Decorative suspended luminaire with LED light sources.



**TECHNICAL DATA** **Mounting:** suspended, on wire suspension (included)  
**Body:** top quality aluminum  
**Colour:** white, silver  
**Power supply efficiency:** >90%

**ELECTRICAL DATA** **Power:** 220-240V 50/60Hz  
**Includes light source:** yes  
**Type of equipment:** ON/OFF, DALI  
**Electrical connection:** max 3x0,75 mm<sup>2</sup> wire, max 5x0,75 mm<sup>2</sup> wire

**OPTICAL DATA** **Way of lighting:** direct  
**Reflector:** polished



**GENERAL DATA** **ULOR / DLOR:** 0/100  
**Lifetime (L80B10):** 100 000 h  
**SDCM:** 3  
**Warranty:** 5 years  
**Application:** offices, conference rooms, reception desks, shopping centers, galleries, boutiques, museums



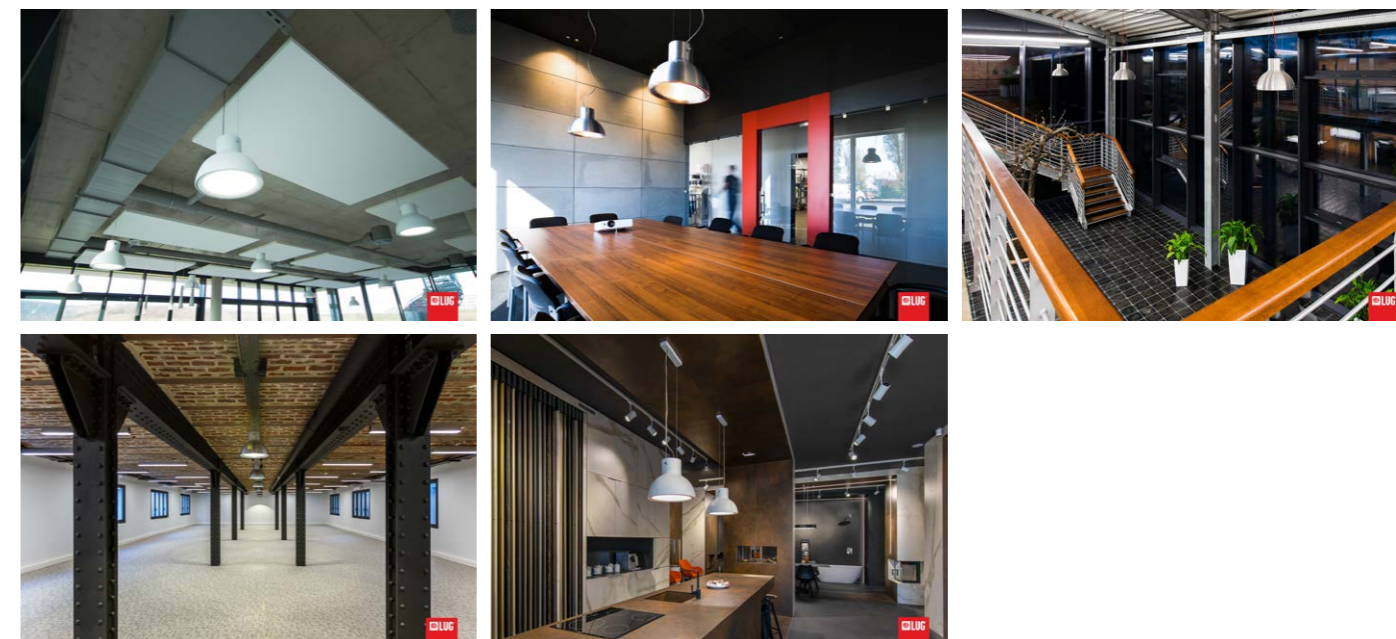

OTHER PICTURES



| Electrical number                  | Code            | Type of equipment | Colour | (W) | (Lm) | (lm/W) | (K)  | CRI/Ra |
|------------------------------------|-----------------|-------------------|--------|-----|------|--------|------|--------|
| <b>White (L403 H312 mm, 4 kg)</b>  |                 |                   |        |     |      |        |      |        |
| 42 427 19                          | 200111.5L02.110 | ON/OFF            | white  | 23  | 2700 | 117    | 4000 | ≥80    |
| 42 427 20                          | 200111.5L04.110 | ON/OFF            | white  | 41  | 4500 | 110    | 4000 | ≥80    |
| 42 427 21                          | 200111.3L02.110 | DALI              | white  | 23  | 2700 | 117    | 4000 | ≥80    |
| 42 427 22                          | 200111.3L04.110 | DALI              | white  | 41  | 4500 | 110    | 4000 | ≥80    |
| <b>Silver (L403 H312 mm, 4 kg)</b> |                 |                   |        |     |      |        |      |        |
|                                    | 200116.3L01.110 | DALI              | silver | 23  | 2450 | 107    | 3000 | ≥80    |
|                                    | 200116.3L02.110 | DALI              | silver | 23  | 2600 | 113    | 4000 | ≥80    |
|                                    | 200116.3L03.110 | DALI              | silver | 41  | 4100 | 100    | 3000 | ≥80    |
|                                    | 200116.3L04.110 | DALI              | silver | 41  | 4300 | 105    | 4000 | ≥80    |

200202.  .L01.111  
 Type of equipment ON/OFF  
 Type of equipment DALI

**Also available in following colours**  
 Black (RAL 9005)  
 Grey (RAL 7035)  
 All RAL colours

DIMENSIONAL DRAWING

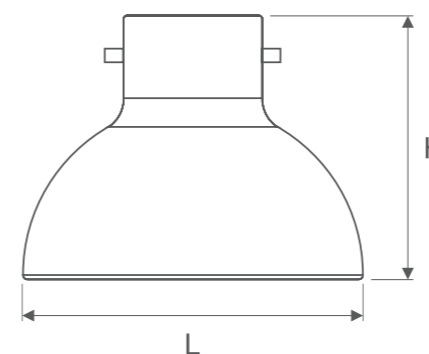

BALLED downlight is an exciting luminaire and a stunning alternative to standard recessed downlights. The light can be tilted and adjusted in any direction by turning the luminaire housing. BALLED has a small and thin flange against the ceiling which creates a nice transition between the roof and the luminaire. The Fresnel lens-optics combined with deeply drawn light source, provides reduced glare and a smoother and more elegant light beam. Warm white light of 2700K and a very good Ra(CRI) >90, for correct color rendering. The LED driver has a connection box with integrated strain relief, and it is prepared for loop-wiring, For easy installation, the cable between the driver and the luminaire is equipped with a quick-connector. Dimmable (Triac dimming) to very low level.

**TECHNICAL DATA** **Mounting:** semi recessed mounting  
**Body:** aluminium  
**Colour:** black, white, copper

**ELECTRICAL DATA** **Includes light source:** YES  
**Power:** 230V 50-60Hz  
**Type of equipment:** triac dimming

**OPTICAL DATA** **Light distribution:** symmetric  
**Way of lighting:** direct

**GENERAL DATA** **Lifetime (L70B50):** 50 000 h  
**SDCM:** 3  
**Warranty:** 5 years



Black

White

Copper

| Electrical number       | Code    | (IP) | (W) | (Lm) | (lm/W) | (K)  | CRI/Ra | Beam angle | Colour | Diameter/height (mm) |
|-------------------------|---------|------|-----|------|--------|------|--------|------------|--------|----------------------|
| <b>Balled Downlight</b> |         |      |     |      |        |      |        |            |        |                      |
| 42 427 04               | 3235700 | 20   | 13  | 680  | 52     | 2700 | 90     | 40         | White  | 113/125              |
| 42 427 05               | 3235701 | 20   | 13  | 680  | 52     | 2700 | 90     | 40         | Black  | 113/125              |
| 42 427 06               | 3235702 | 20   | 13  | 680  | 52     | 2700 | 90     | 40         | Copper | 113/125              |

**OTHER PICTURES**



**DIMENSIONAL DRAWING**

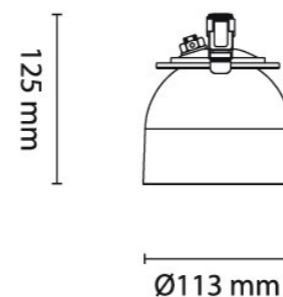

BALLED pedant is an elegant luminaire in the same design-family as the Balled downlight. The rounded shape and the glare free light makes the Balled fit into every interior. a BALLED comes with at circular shaped mounting box which covers the ceiling-installation box. The Fresnel lens-optics combined with deeply drawn light source, provides reduced glare and a smoother and more elegant light beam. Warm white light of 2700K and a very good Ra(CRI) >90, for correct color rendering. Dimmable (Triac dimming) to very low level.

**TECHNICAL DATA** Mounting: pedant mounting with surface box  
Body: aluminium  
Colour: black, white, copper

**ELECTRICAL DATA** Includes light source: YES  
Power: 230V 50-60Hz  
Type of equipment: triac dimming

**OPTICAL DATA** Light distribution: symmetric  
Way of lighting: direct

**GENERAL DATA** Lifetime (L70B50): 50 000 h  
SDCM: 3  
Warranty: 5 years



Black

White

Copper

| Electrical number      | Code    | (IP) | (W) | (Lm) | (lm/W) | (K)  | CRI/Ra | Beam angle | Colour | Diameter/height (mm) | Cable length (mm) |
|------------------------|---------|------|-----|------|--------|------|--------|------------|--------|----------------------|-------------------|
| <b>Balled Pendulum</b> |         |      |     |      |        |      |        |            |        |                      |                   |
| 42 427 07              | 3235710 | 20   | 13  | 680  | 52     | 2700 | 90     | 40         | White  | 113/95               | 3000              |
| 42 427 08              | 3235711 | 20   | 13  | 680  | 52     | 2700 | 90     | 40         | Black  | 113/95               | 3000              |
| 42 427 09              | 3235712 | 20   | 13  | 680  | 52     | 2700 | 90     | 40         | Copper | 113/95               | 3000              |

OTHER PICTURES

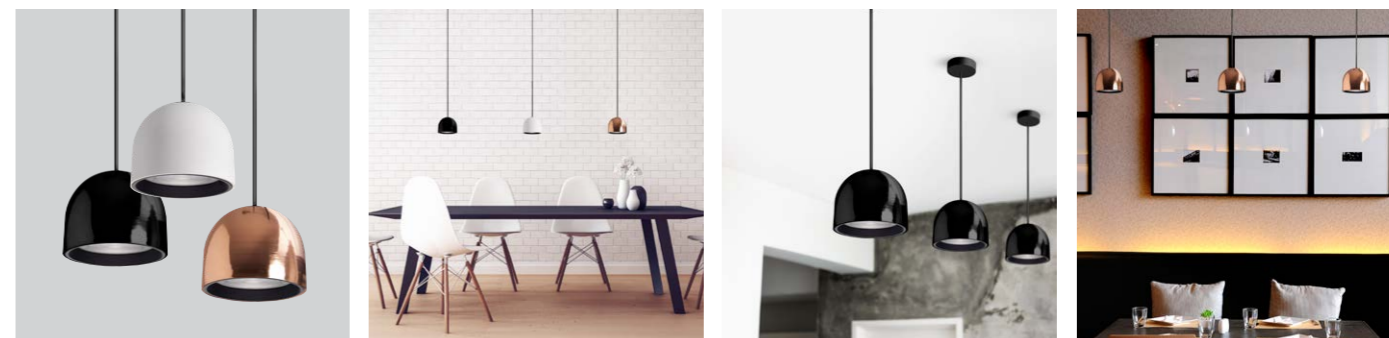

DIMENSIONAL DRAWING

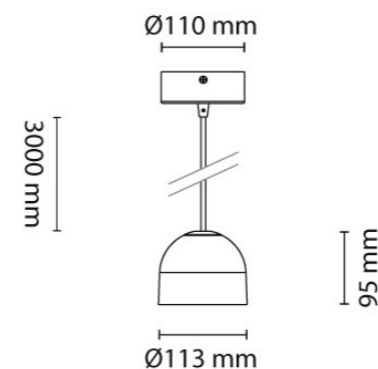



**TILT**  
(page 26)

**BALLED PENDULUM**  
(page 124)



Suspended decorative luminaire with LED light sources. The luminaire consists of 4 cubes, appearing in 2 colors with a different surface finish.

**TECHNICAL DATA** **Mounting:** suspended, on wire suspension (included)  
**Body:** plastic  
**Colour:** dark gray, black  
**Diffuser:** opal plexiglass (PLX)

**ELECTRICAL DATA** **Power supply efficiency:** 84%  
**Power:** 220-240V 50/60Hz  
**Includes light source:** yes  
**Type of equipment:** ON/OFF, DALI

**OPTICAL DATA** **Electrical connection:** max 3x0,75 mm<sup>2</sup> wire, max 5x0,75 mm<sup>2</sup> wire  
**Light distribution:** rotationally-symmetric  
**Way of lighting:** direct

**GENERAL DATA** **Lifetime (L70B50):** 65 000 h  
**Lifetime (L80B10):** 40 000 h  
**Lifetime (TM21 L90B10):** 20 000 h  
**SDCM:** 3  
**Warranty:** 5 years  
**Application:** offices, conference rooms, reception desks, shopping centers, car showrooms, boutiques, airports

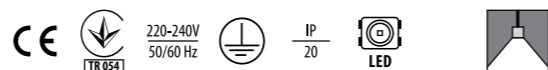

Available in different combinations

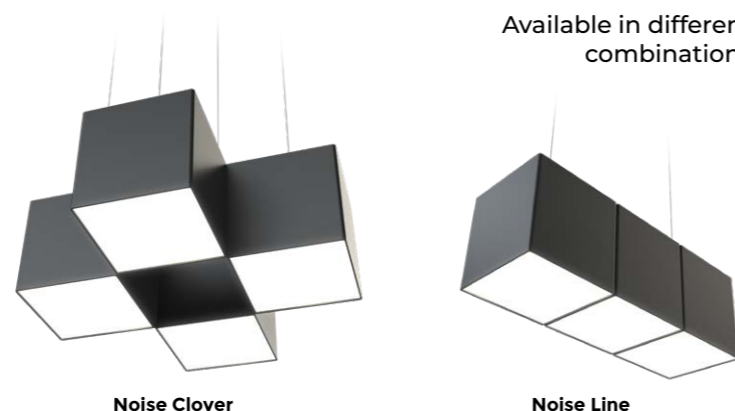

Noise Clover

Noise Line

| Electrical number                               | Code            | Colour | Surface finish | Type of equipment | (W) | (Lm) | (lm/W) | (K)  | CRI/Ra | (°C)      |
|---|-----------------|--------|----------------|-------------------|-----|------|--------|------|--------|-----------|
| <b>Noise Line (L140 W408 H140 mm, 3,6 kg)</b>   |                 |        |                |                   |     |      |        |      |        |           |
| 42 427 23                                       | 200163.5L02.111 | black  | matt           | ON/OFF            | 13  | 1000 | 77     | 4000 | 80     | 0 ... +35 |
| 42 427 24                                       | 200163.3L02.111 | black  | matt           | DALI              | 13  | 1000 | 77     | 4000 | 80     | 0 ... +35 |
| 42 427 25                                       | 200169.5L02.111 | grey   | matt           | ON/OFF            | 13  | 1000 | 77     | 4000 | 80     | 0 ... +35 |
| 42 427 26                                       | 200169.3L02.111 | grey   | matt           | DALI              | 13  | 1000 | 77     | 4000 | 80     | 0 ... +35 |
| <b>Noise Clover (L408 W408 H140 mm, 3,6 kg)</b> |                 |        |                |                   |     |      |        |      |        |           |
|   | 200203.XL01.122 | black  | gloss          |                   | 17  | 1400 | 82     | 3000 | 80     | 0 ... +35 |
|   | 200203.XL02.122 | black  | gloss          |                   | 17  | 1400 | 82     | 4000 | 80     | 0 ... +35 |

200202. .L01.111  
 Type of equipment ON/OFF  
 Type of equipment DALI

Also available in following colours  
 Graphite (RAL 7016)  
 White (RAL 9010)  
 All RAL colours

OTHER COMBINATIONS

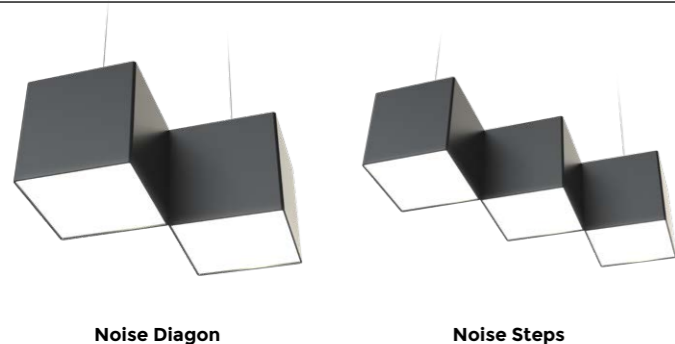

Noise Diagon

Noise Steps

OTHER PICTURES



Dark gray matt

Black matt

Black gloss

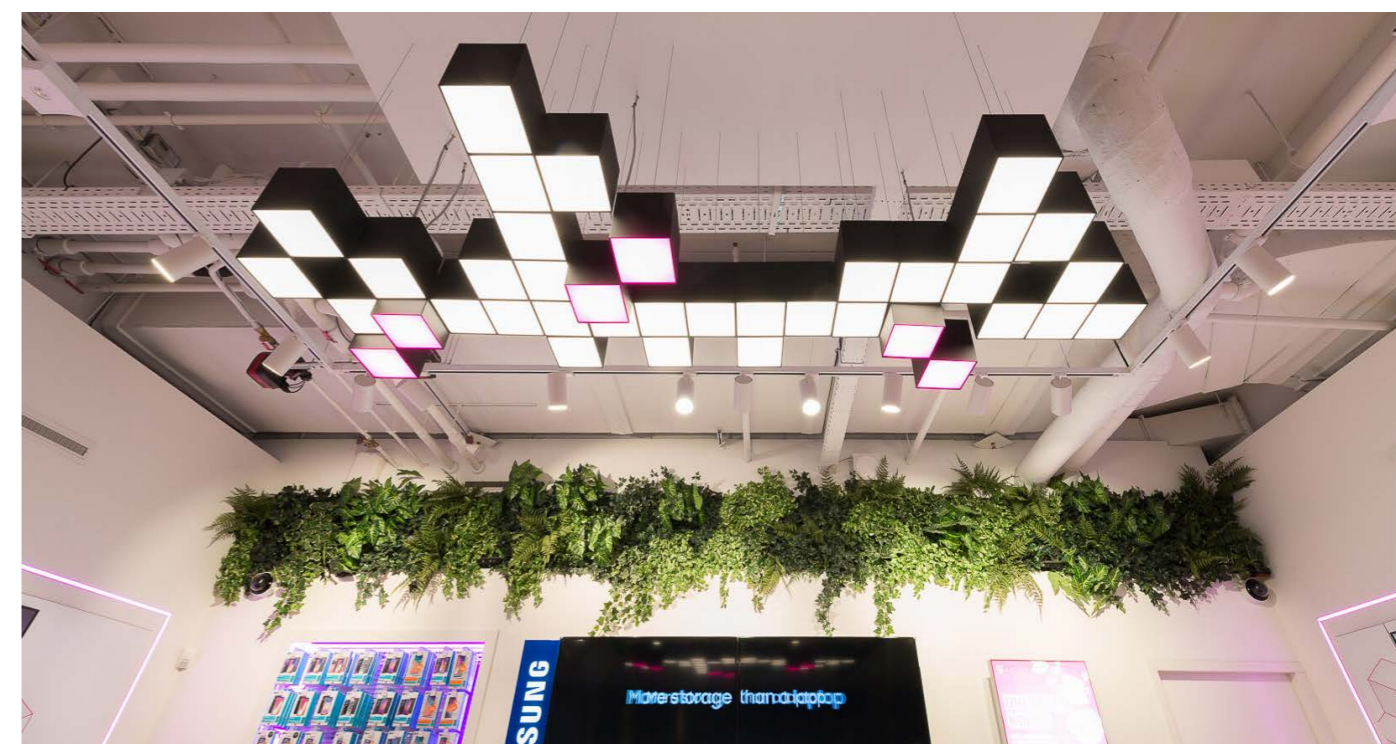

DIMENSIONAL DRAWING

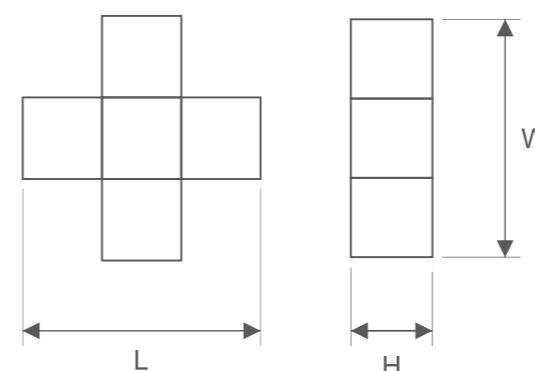

Lithium drop-blade exit sign with up, down, left/right arrow sing. 3h lithium battery.

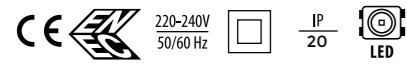

- CONSTRUCTION** Mounting: ceiling mounted, optional bracket for wall mounting available  
**Body:** white polycarbonate  
**Blade:** clear acrylic  
**Signs:** supplied with complete set of ISO signs (up, down, left/right)
- TECHNICAL DATA** **Driver:** included, integral  
**Dimming:** not available  
**Power factor:** >.95  
**Electrical connection:** 4-pole terminal block  
**Mode of operation:** maintained  
**Battery duration:** 3 hours
- GENERAL DATA** **Battery type:** lithium iron phosphate (LiFePO<sub>4</sub>)  
**Application:** emergency signage for exit routes  
**Operating temperature:** 0°C - +25°C  
**Lumen depreciation:** L80: B10: 50,000 hours  
**SDCM:** N/A  
**Warranty:** 5 years



**DIMENSIONAL DRAWING**

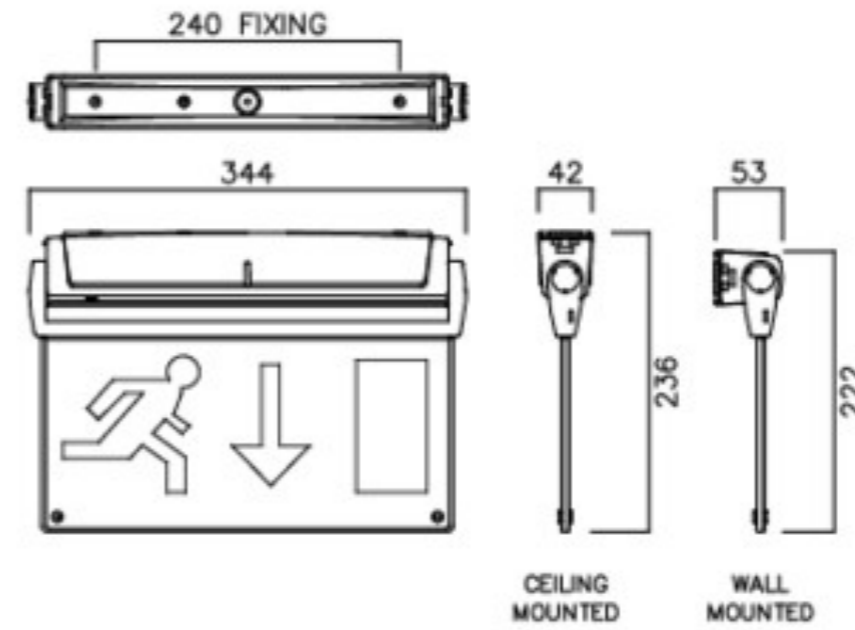

| Electrical number | Code       | (W) | Distance (m) | Width/height (mm) |
|-------------------|------------|-----|--------------|-------------------|
| Arlington Pro     |            |     |              |                   |
| 42 665 34         | NAL/M3/ISO | 2   | 30           | 344/236           |

IP65 lithium LED emergency bulkhead

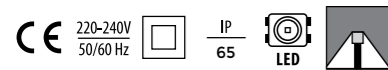

- CONSTRUCTION** **Mounting:** ceiling or wall mounted
- Body:** white polycarbonate
- Cover:** clear polycarbonate
- Signs:** supplied with a set of 4 ISO signs
- TECHNICAL DATA** **Driver:** included, integral
- Dimming:** not available
- Power factor:** N/A
- Electrical connection:** 4 x 2 x 2.5mm<sup>2</sup> terminal block
- Mode of operation:** M3/NM3 as installed
- Battery duration:** 3 hours
- Battery type:** lithium iron phosphate (LiFePO<sub>4</sub>)
- GENERAL DATA** **Application:** emergency lighting and signage for exit routes
- Operating temperature:** 0°C - +25°C
- Lumen depreciation:** L80: B10: 50,000 hours
- SDCM:** N/A
- Warranty:** 5 years



DIMENSIONAL DRAWING

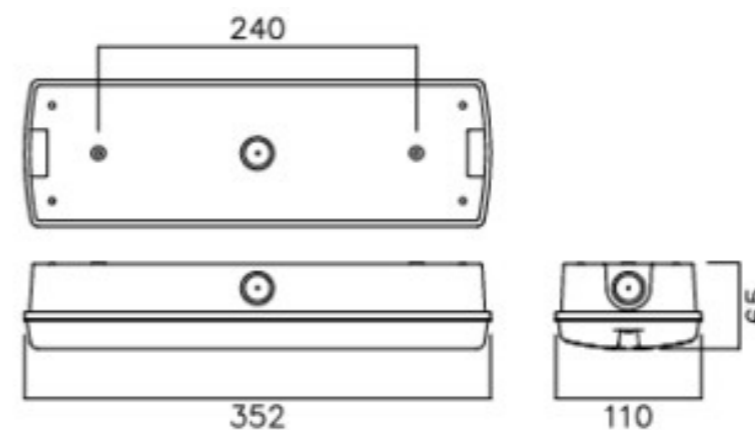

LIGHT BEAM CURVES

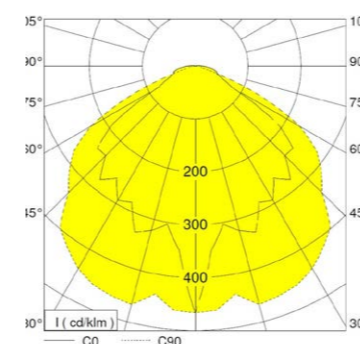

NEBRASKA

| Electrical number | Code                     | W   | lm                       | lm/W | Distance (m) | K    | CRI/Ra |
|-------------------|--------------------------|-----|--------------------------|------|--------------|------|--------|
| <b>Nebraska</b>   |                          |     |                          |      |              |      |        |
| 42 665 33         | NNE/2/LED/M3/LITH/ISO/V3 | 3.5 | 175(mains) 115 (battery) | 49   | 20           | 6650 | ≥80    |

Low structure Universal IP44 luminaire is mainly used for hallways, corridors, office buildings and in industrial facilities. It has 3 different lengths and colour temperature can be chosen between 3000K and 4000K.

- TECHNICAL DATA** **Mounting:** surface mounting
- Body:** steal
- Colour:** white
- Diffuser:** opal
- ELECTRICAL DATA** **Includes light source:** YES
- Type of equipment:** ON/OFF
- Electrical connection:** 5x2,5mm<sup>2</sup>, loopable
- OPTICAL DATA** **Light distribution:** symmetric
- Way of lighting:** direct
- GENERAL DATA** **Lifetime (L80B50):** 50 000 h
- SDCM:** 3
- Warranty:** 5 years



| Electrical number                           | (IP) | (W) | (Lm)      | (lm/W) | (K)       | CRI/Ra | (°C)       | Measurements L/W/H (mm) |
|---|------|-----|-----------|--------|-----------|--------|------------|-------------------------|
| <b>Universal (1,2 kg / 2,2 kg / 2,6 kg)</b> |      |     |           |        |           |        |            |                         |
| 43 625 26                                   | 44   | 25  | 2380/2500 | 95/100 | 3000/4000 | 80     | 0...+25 °C | 600/143/44,5            |
| 43 625 27                                   | 44   | 45  | 4280/4500 | 95/100 | 3000/4000 | 80     | 0...+25 °C | 1200/143/44,5           |
| 43 625 28                                   | 44   | 60  | 5700/6000 | 95/100 | 3000/4000 | 80     | 0...+25 °C | 1500/143/44,5           |

**OTHER PICTURES**



**DIMENSIONAL DRAWING**

43 625 26 Universal IP44 25W 3/4K

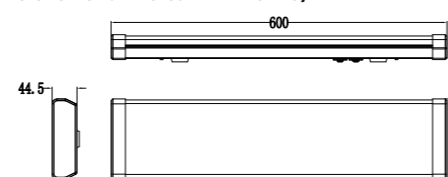

43 625 27 Universal IP44 45W 3/4K

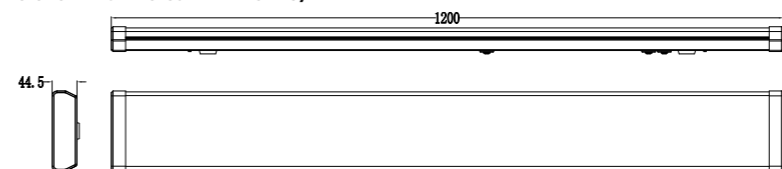

43 625 28 Universal IP44 60W 3/4K

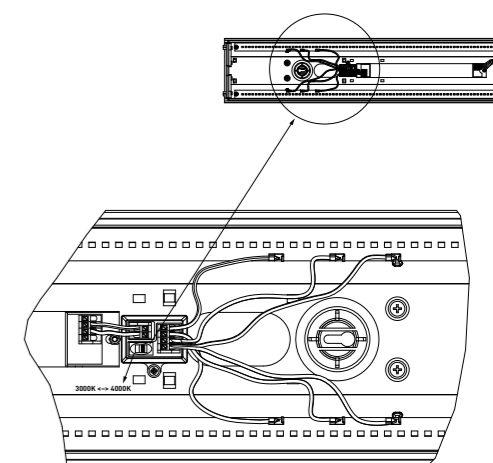
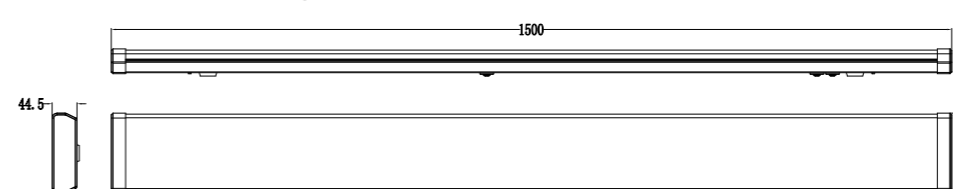

**LIGHT BEAM CURVES**

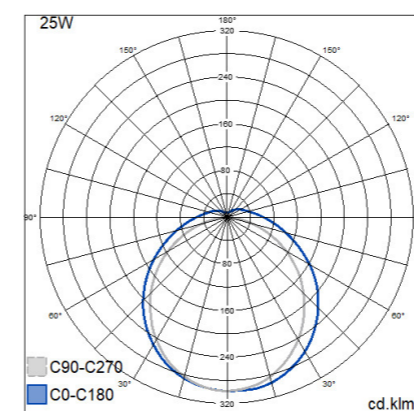



IP44 surface mounted LED linear fitting

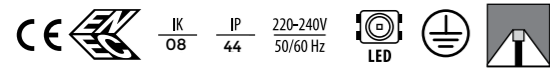

**CONSTRUCTION** Body: steel, white painted, RAL9016  
End-caps: moulded white polycarbonate  
Diffuser: opal polycarbonate

**TECHNICAL DATA** Driver: included, integral  
Dimming: DALI available as listed  
Power factor: >.95  
Electrical connection: 2.5mm<sup>2</sup> loop-in / loop-out

**GENERAL DATA** Application: corridors, offices, classrooms & general commercial use  
Operating temperature: -20°C - +25°C  
Lumen depreciation: L90: B10: 100,000 hours  
SDCM: <3  
Warranty: 5 years



| Electrical number      | Code               | W  | lm   | lm/W | Type of equipment | K          | CRI/Ra |
|------------------------|--------------------|----|------|------|-------------------|------------|--------|
| <b>Cornell 600 mm</b>  |                    |    |      |      |                   |            |        |
| 43 440 30              | BB/NCR20/O/830-840 | 20 | 2330 | 117  | ON/OFF            | 3000/4000K | ≥80    |
| 43 440 36              | NCR20/O/DA/830-840 | 20 | 2330 | 117  | DALI              | 3000/4000K | ≥80    |
| 43 440 31              | NCR20/O/MW/830-840 | 20 | 2330 | 117  | RADAR             | 3000/4000K | ≥80    |
| <b>Cornell 1200 mm</b> |                    |    |      |      |                   |            |        |
| 43 440 32              | BB/NCR40/O/830-840 | 40 | 4795 | 120  | ON/OFF            | 3000/4000K | ≥80    |
| 43 440 37              | NCR40/O/DA/830-840 | 40 | 4795 | 120  | DALI              | 3000/4000K | ≥80    |
| 43 440 33              | NCR40/O/MW/830-840 | 40 | 4795 | 120  | RADAR             | 3000/4000K | ≥80    |
| <b>Cornell 1500 mm</b> |                    |    |      |      |                   |            |        |
| 43 440 34              | BB/NCR50/O/830-840 | 50 | 6000 | 120  | ON/OFF            | 3000/4000K | ≥80    |
| 43 440 38              | NCR50/O/DA/830-840 | 50 | 6000 | 120  | DALI              | 3000/4000K | ≥80    |
| 43 440 35              | NCR50/O/MW/830-840 | 50 | 6000 | 120  | RADAR             | 3000/4000K | ≥80    |

OTHER PICTURES



DIMENSIONAL DRAWING

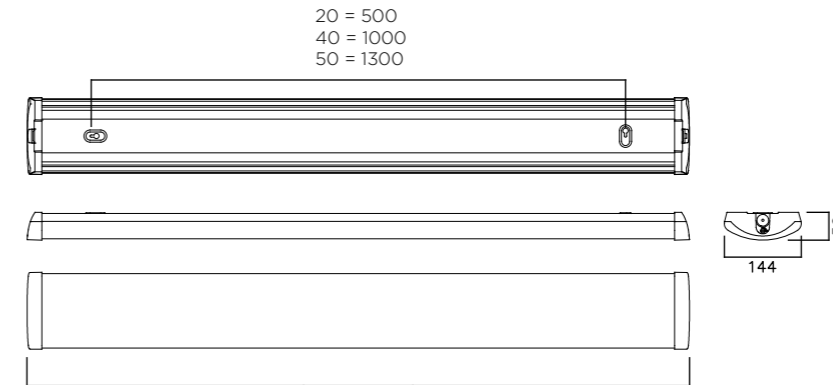

LIGHT BEAM CURVES

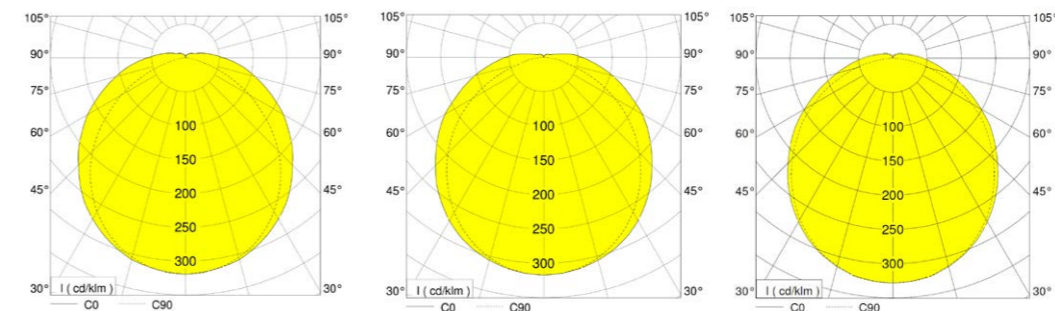

CORNELL 20W

CORNELL 40W

CORNELL 50W



IP66 non-corrosive LED linear fitting with dimming options

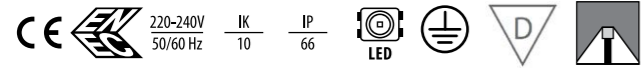

**CONSTRUCTION** **Mounting:** for surface or suspended mounting  
**Body:** grey polycarbonate  
**Cover:** opal polycarbonate  
**Clips:** grade 316 stainless steel  
**Driver:** included, integral  
**Dimming:** digital dimming available as listed  
**Power factor:** >.95  
**Electrical connection:** 2.5mm<sup>2</sup> loop-in / loop-out  
**Wiring:** through-wired, 5-pole  
**Application:** industry, workshops, warehouses & changing rooms  
**Operating temperature:** -20°C - +25°C  
**Lumen depreciation:** L80: B10: 100,000 hours  
**SDCM:** <3  
**Warranty:** 5 years



| Electrical number        | Code               | W  | lm   | lm/W | Type of equipment | K    | CRI/Ra |
|--------------------------|--------------------|----|------|------|-------------------|------|--------|
| <b>Greenland 1200 mm</b> |                    |    |      |      |                   |      |        |
| 43 440 00                | BB/NGN2X4/TW5P/840 | 45 | 6370 | 140  | ON/OFF            | 4000 | ≥80    |
| 43 440 02                | NGN2X4/TW5P/DD/840 | 45 | 6370 | 140  | DALI              | 4000 | ≥80    |
| <b>Greenland 1500 mm</b> |                    |    |      |      |                   |      |        |
| 43 440 01                | BB/NGN2X5/TW5P/840 | 73 | 9865 | 135  | ON/OFF            | 4000 | ≥80    |
| 43 440 03                | NGN2X5/TW5P/DD/840 | 73 | 9865 | 135  | DALI              | 4000 | ≥80    |

**OTHER PICTURES**



**DIMENSIONAL DRAWING**

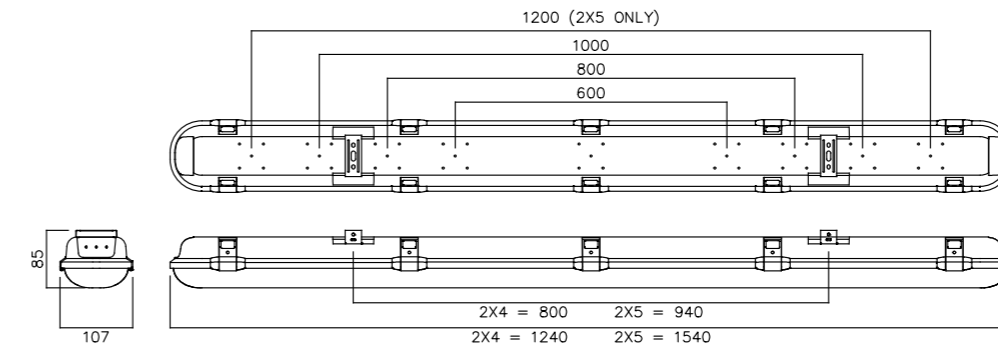

**LIGHT BEAM CURVES**

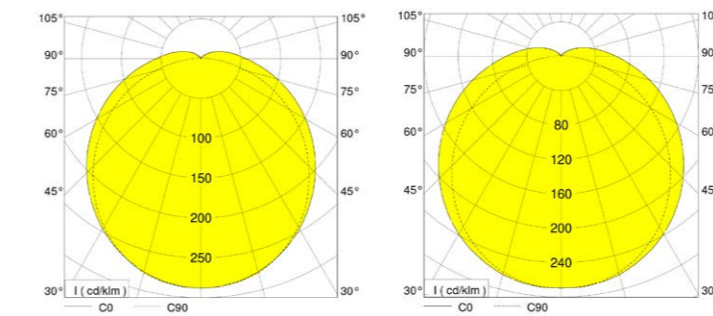

Greenland NGN2x4

Greenland NGN2x5



IP65 LED linear non-corrosive fitting

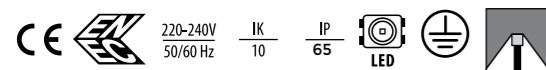

**CONSTRUCTION** **Mounting:** for surface or suspended mounting  
**Body:** grey polycarbonate  
**Cover:** opal polycarbonate  
**Clips:** grade 316 stainless steel

**TECHNICAL DATA** **Driver:** included, integral  
**Dimming:** not available  
**Power factor:** >.95  
**Electrical connection:** 2.5mm<sup>2</sup>

**GENERAL DATA** **Application:** industry, workshops, warehouses & changing rooms  
**Operating temperature:** -20°C - +25°C  
**Lumen depreciation:** L70: B10: 50,000 hours  
**SDCM:** <5  
**Warranty:** 5 years



| Electrical number        | Code       | W  | lm   | lm/W | K    | CRI/Ra |
|--------------------------|------------|----|------|------|------|--------|
| <b>Cleveland 1200 mm</b> |            |    |      |      |      |        |
| 43 440 22                | NCV2X4/840 | 40 | 4600 | 115  | 4000 | ≥80    |
| <b>Cleveland 1500 mm</b> |            |    |      |      |      |        |
| 43 440 23                | NCV2X5/840 | 57 | 6600 | 114  | 4000 | ≥80    |

OTHER PICTURES



CLEVELAND

DIMENSIONAL DRAWING

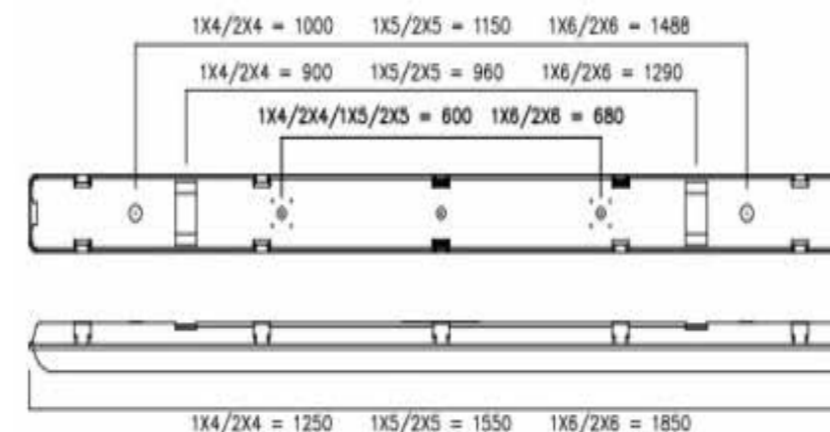

LIGHT BEAM CURVES

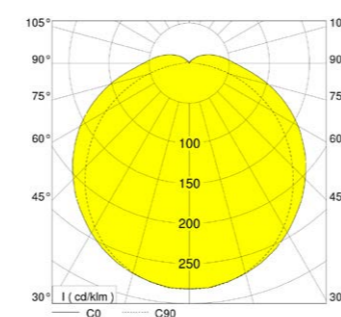

CLEVELAND-2x4

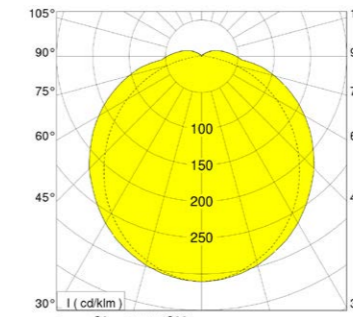

CLEVELAND-2x5



**GREENLAND**  
(page 142)

Aluminium framed powerful luminaire for parking halls and other spaces where wide light distribution is needed. Led-module can be replaced.

- TECHNICAL DATA**  
**Mounting:** ceiling, wall, rail and suspended  
**Body:** aluminum profile  
**Colour:** grey, white on request  
**Diffuser:** micro prismatic (MP) & satin opal (SO) PMMA acrylic  
**Through wiring:** 2 x 5 x 2,5mm<sup>2</sup>
- ELECTRICAL DATA**  
**Power:** 230V 50Hz  
**Includes light source:** yes  
**Type of equipment:** ON/OFF
- OPTICAL DATA**  
**Light distribution:** symmetric  
**Way of lighting:** direct
- GENERAL DATA**  
**Lifetime (L80B50):** 100 000h  
**Available on request:** Dali or Dali/SWD  
**SDCM:** 3  
**Warranty:** 5 years  
**Application:**



| Electrical number | (IP) | (W) | (Lm)  | (lm/W) | (K)  | Diffuser | CRI/Ra | C10/C16 | Length/width/height (mm) | Weight (kg) |
|-------------------|------|-----|-------|--------|------|----------|--------|---------|--------------------------|-------------|
| <b>Grey</b>       |      |     |       |        |      |          |        |         |                          |             |
| 4362514           | 65   | 28  | 3830  | 137    | 4000 | SO       | >80    | 23/39   | 1140/80/90               | 4           |
| 4362515           | 65   | 28  | 3950  | 141    | 4000 | PR       | >80    | 23/39   | 1140/80/90               | 4           |
| 4362516           | 65   | 45  | 6160  | 137    | 4000 | SO       | >80    | 23/39   | 1140/80/90               | 4           |
| 4362517           | 65   | 45  | 6340  | 141    | 4000 | PR       | >80    | 23/39   | 1140/80/90               | 4           |
| 4362518           | 65   | 56  | 7670  | 137    | 4000 | SO       | >80    | 23/39   | 1420/80/90               | 5           |
| 4362519           | 65   | 56  | 7890  | 141    | 4000 | PR       | >80    | 23/39   | 1420/80/90               | 5           |
| 4362520           | 65   | 69  | 9450  | 137    | 4000 | SO       | >80    | 23/39   | 1420/80/90               | 5           |
| 4362521           | 65   | 69  | 9730  | 141    | 4000 | PR       | >80    | 23/39   | 1420/80/90               | 5           |
| 4362522           | 65   | 80  | 10960 | 137    | 4000 | SO       | >80    | 23/39   | 1700/80/90               | 7           |
| 4362523           | 65   | 80  | 11280 | 141    | 4000 | PR       | >80    | 23/39   | 1700/80/90               | 7           |
| 4362525           | 65   | 92  | 12600 | 137    | 4000 | SO       | >80    | 12/28   | 2260/80/90               | 9           |
| 4362524           | 65   | 92  | 12970 | 141    | 4000 | PR       | >80    | 12/28   | 2260/80/90               | 9           |

**OTHER PICTURES**



**DIMENSIONAL DRAWING**

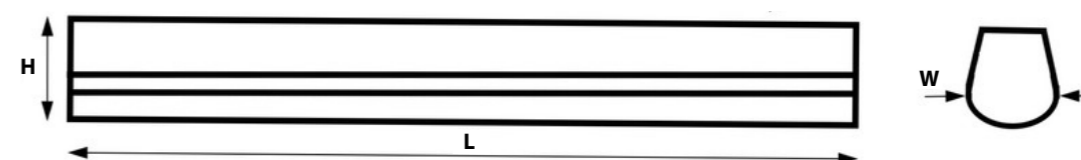

**LIGHT BEAM CURVES**

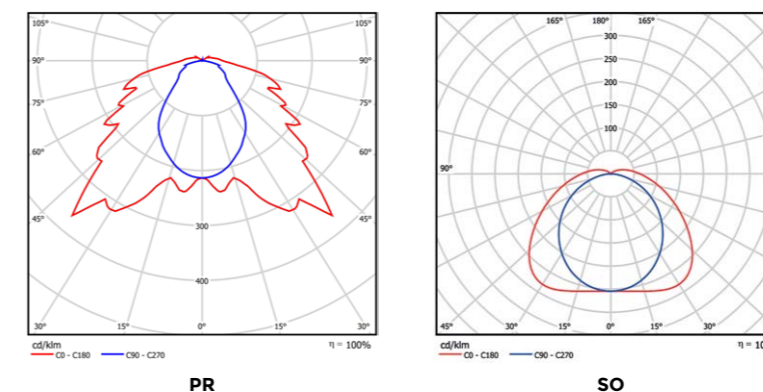

Hermetic LED luminaire, water-jet proof, intended for mounting inside industrial or architectural objects.

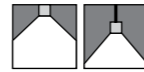

**TECHNICAL DATA**  
**Mounting:** directly on the ceiling, with mounting brackets (included), suspended, on chains, on wire suspension (on request)  
**Body:** plastic  
**Colour:** light gray, graphite, red  
**Diffuser:** polycarbonate

**ELECTRICAL DATA**  
**Power supply efficiency:** >90%  
**Power:** 220-240V 50/60Hz  
**Includes light source:** yes  
**Type of equipment:** STANDARD + through wiring (TW) 5x1,5 mm<sup>2</sup>, DALI + through wiring (TW) 5x1,5 mm<sup>2</sup>

**OPTICAL DATA**  
**Electrical connection:** max 3x1,5 mm<sup>2</sup> wire, max 3x1,5 mm<sup>2</sup> / 2x1,5 mm<sup>2</sup> wire, max 5x1,5 mm<sup>2</sup> wire  
**Light distribution:** omnidirectional  
**Way of lighting:** direct  
**Type of optic:** opal diffuser

**GENERAL DATA**  
**Lifetime (L80B10):** 100 000 h; 85 000 h - High Efficacy  
**Available on request:** available with connection to a central battery power supply, radar motion detector, twilight sensor  
**Additional information:** CRI/Ra ≥80, EASY CONNECT  
**SDCM:** 3  
**Warranty:** 5 years  
**Application:** parking areas, production halls, warehouses, assembly halls, electricity plants, mills, workshops, wood and paper industry

| Electrical number   | Code                | Type          | (W) | (Lm) | (lm/W) | (K)  | (°C)        |
|---|---------------------|---------------|-----|------|--------|------|-------------|
| <b>STANDARD + through wiring (TW) 5x1,5 mm<sup>2</sup> (L1245 W100 H90 D766 mm, 1,8 kg)</b> |                     |               |     |      |        |      |             |
| 43 390 68   | 090380.5L02.011.938 | -             | 31  | 4700 | 152    | 4000 | -25 ... +30 |
| 43 390 69   | 090380.5L04.011.938 | -             | 40  | 6250 | 156    | 4000 | -25 ... +30 |
| 43 390 70   | 090380.5L06.011.938 | -             | 48  | 7450 | 155    | 4000 | -25 ... +30 |
|   | 090380.5L07.0X1.938 | High Efficacy | 26  | 4700 | 181    | 4000 | -20 ... +30 |
|   | 090380.5L08.0X1.938 | High Efficacy | 35  | 6250 | 179    | 4000 | -20 ... +30 |
|   | 090380.5L09.0X1.938 | High Efficacy | 42  | 7450 | 177    | 4000 | -20 ... +30 |
| <b>DALI + through wiring (TW) 5x1,5 mm<sup>2</sup> (L1245 W100 H90 D766 mm, 1,8 kg)</b>     |                     |               |     |      |        |      |             |
| 43 390 71   | 090380.3L02.011.938 | -             | 31  | 4700 | 152    | 4000 | -25 ... +30 |
| 43 390 72   | 090380.3L04.011.938 | -             | 40  | 6250 | 156    | 4000 | -25 ... +30 |
| 43 390 73   | 090380.3L06.011.938 | -             | 48  | 7450 | 155    | 4000 | -25 ... +30 |
|   | 090380.3L07.0X1.938 | High Efficacy | 26  | 4700 | 181    | 4000 | -20 ... +30 |
|   | 090380.3L08.0X1.938 | High Efficacy | 35  | 6250 | 179    | 4000 | -20 ... +30 |
|   | 090380.3L09.0X1.938 | High Efficacy | 42  | 7450 | 177    | 4000 | -20 ... +30 |

- 090380.5L02.0 1
- Colour**
- 1 Light gray
  - 2 Graphite (not applicable to "High Efficacy" version)
  - 3 Red (not applicable to "High Efficacy" and "low assembly" versions)

OTHER PICTURES



Version with 3h emergency module

DIMENSIONAL DRAWING

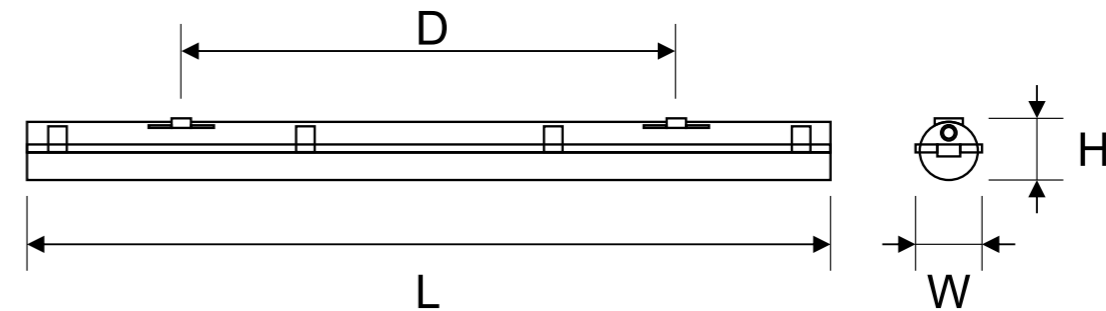

ACCESSORIES



150060.00987



150060.00062  
Suspension hanger MINI

Industrial luminaire for special applications.

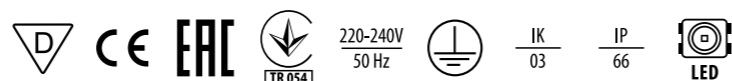

**TECHNICAL DATA** Mounting: with mounting brackets (included)  
Body: plastic (GRP)  
Colour: light gray  
Diffuser: acrylic (PMMA)

**ELECTRICAL DATA** Power supply efficiency: >88%  
Power: 220-240V 50Hz  
Includes light source: yes  
Type of equipment: ON/OFF

**OPTICAL DATA** Electrical connection: max 3x1,5-2,5 mm<sup>2</sup> wire  
Light distribution: omnidirectional  
Way of lighting: direct  
Type of optic: diffuser - opal plexiglass (PLX)

**GENERAL DATA** Lifetime (L80B10): 50 000 h  
Operating temperature range: -20 °C ... +35 °C  
SDCM: 5  
Warranty: 5 years  
Application: laboratories, industrial facilities, Livestock facilities, chicken farms, pig farms.



| Electrical number                                       | Code            | (W) | (Lm) | (lm/W) | (K)  | CRI/Ra | (°C)        |
|---|-----------------|-----|------|--------|------|--------|-------------|
| <b>Atlantyk Chemical (L669 W86 H95 D360, 1,0 kg)</b>    |                 |     |      |        |      |        |             |
|   | 090530.5L01.101 | 14  | 2100 | 150    | 4000 | ≥80    | -20 ... +35 |
| <b>Atlantyk Chemical (L1277 W86 H95 D700, 1,7 kg)</b>   |                 |     |      |        |      |        |             |
|   | 090530.5L02.101 | 26  | 4150 | 160    | 4000 | ≥80    | -20 ... +35 |
| <b>Atlantyk Chemical (L1577 W86 H95 D1000, 1,9 kg)</b>  |                 |     |      |        |      |        |             |
|   | 090530.5L03.101 | 32  | 5000 | 156    | 4000 | ≥80    | -20 ... +35 |
| <b>Atlantyk Chemical (L1577 W112 H99 D1000, 2,4 kg)</b> |                 |     |      |        |      |        |             |
|   | 090530.5L04.101 | 43  | 6600 | 153    | 4000 | ≥80    | -20 ... +35 |

OTHER PICTURES



DIMENSIONAL DRAWING

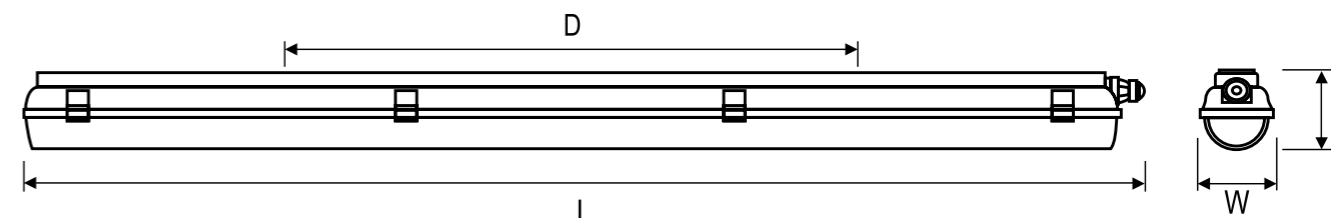

ACCESSORIES



150060.00987



150110.00765

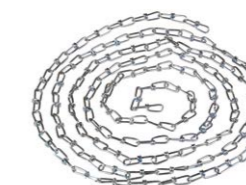

150110.00819  
150110.00820



Industrial luminaire for LED light sources with high efficiency up to 149 lm/W.

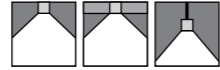

**TECHNICAL DATA**  
**Mounting:** surface mounted, in the ceiling, with mounting frame (sold separately), suspended, on chains (on request), for hanging on a cable, with special mounting bracket (on request)  
**Body:** high pressure die-cast aluminum  
**Colour:** gray  
**Diffuser:** tempered glass  
**Power supply efficiency:** 90%

**ELECTRICAL DATA**  
**Power:** 220-240V 50/60Hz  
**Includes light source:** yes  
**Type of equipment:** ON/OFF, DALI  
**Electrical connection:** max 3x2,5 mm<sup>2</sup> wire, max 5x2,5 mm<sup>2</sup> wire  
**Light distribution:** street, rotationally-symmetric

**OPTICAL DATA**  
**Way of lighting:** direct  
**Type of optic:** lens  
**ULOR / DLOR:** 0/100

**GENERAL DATA**  
**Lifetime (L80B10):** 100 000 h  
**Additional information:** ball impact resistance. The possibility of using one or more power supplies in the luminaire.  
**SDCM:** 5  
**Warranty:** 5 years  
**Application:** warehouses, logistics centers, industrial facilities, sport facilities, tunnels, roofing, outdoor mounting without roof on special request (index extension: .985)

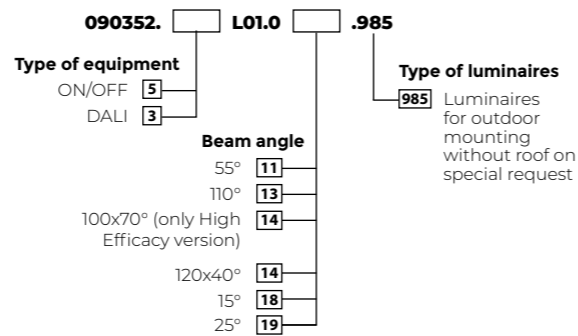

| Electrical number                               | Code            | Type of equipment | Beam angle | (W) | (Lm)  | (lm/W) | (K)  | CRI/Ra | (°C)        |
|---|-----------------|-------------------|------------|-----|-------|--------|------|--------|-------------|
| <b>HIGH EFFICACY (L515 W345 H90 mm, 6,5 kg)</b> |                 |                   |            |     |       |        |      |        |             |
| 43 391 19                                       | 090432.5L04.011 | ON/OFF            | 55         | 105 | 14000 | 133    | 4000 | ≥80    | -40 ... +55 |
| 43 391 20                                       | 090432.3L04.011 | DALI              | 55         | 103 | 14000 | 136    | 4000 | ≥80    | -40 ... +55 |
| 43 391 21                                       | 090432.5L04.013 | ON/OFF            | 110        | 105 | 13250 | 126    | 4000 | ≥80    | -40 ... +55 |
| 43 391 22                                       | 090432.3L04.013 | DALI              | 110        | 103 | 13250 | 129    | 4000 | ≥80    | -40 ... +55 |
| 43 391 23                                       | 090432.5L04.014 | ON/OFF            | 100x70     | 105 | 13050 | 124    | 4000 | ≥80    | -40 ... +55 |
| 43 391 24                                       | 090432.3L04.014 | DALI              | 100x70     | 103 | 13050 | 127    | 4000 | ≥80    | -40 ... +55 |
| 43 391 25                                       | 090432.5L05.011 | ON/OFF            | 55         | 138 | 18450 | 134    | 4000 | ≥80    | -40 ... +55 |
| 43 391 26                                       | 090432.3L05.011 | DALI              | 55         | 137 | 18450 | 135    | 4000 | ≥80    | -40 ... +55 |
| 43 391 27                                       | 090432.5L05.013 | ON/OFF            | 110        | 138 | 18300 | 133    | 4000 | ≥80    | -40 ... +55 |
| 43 391 28                                       | 090432.3L05.013 | DALI              | 110        | 137 | 18300 | 134    | 4000 | ≥80    | -40 ... +55 |
| 43 391 29                                       | 090432.5L05.014 | ON/OFF            | 100x70     | 138 | 18000 | 130    | 4000 | ≥80    | -40 ... +55 |
| 43 391 30                                       | 090432.3L05.014 | DALI              | 100x70     | 137 | 18000 | 131    | 4000 | ≥80    | -40 ... +55 |
| 43 391 31                                       | 090432.5L06.011 | ON/OFF            | 55         | 174 | 22750 | 131    | 4000 | ≥80    | -40 ... +55 |
| 43 391 32                                       | 090432.3L06.011 | DALI              | 55         | 170 | 22750 | 134    | 4000 | ≥80    | -40 ... +55 |
| 43 391 33                                       | 090432.5L06.013 | ON/OFF            | 110        | 174 | 22600 | 130    | 4000 | ≥80    | -40 ... +55 |
| 43 391 34                                       | 090432.3L06.013 | DALI              | 110        | 170 | 22600 | 133    | 4000 | ≥80    | -40 ... +55 |
| 43 391 35                                       | 090432.5L06.014 | ON/OFF            | 100x70     | 174 | 22250 | 128    | 4000 | ≥80    | -40 ... +50 |
| 43 391 36                                       | 090432.3L06.014 | DALI              | 100x70     | 170 | 22250 | 131    | 4000 | ≥80    | -40 ... +50 |

Also available in following colours

- Black (RAL 9005)
- White (RAL 9010)

OTHER PICTURES



Luminaire suspended on a cable with a special mounting bracket - bottom view



Luminaire suspended on a cable with a special mounting bracket - top view

DIMENSIONAL DRAWING

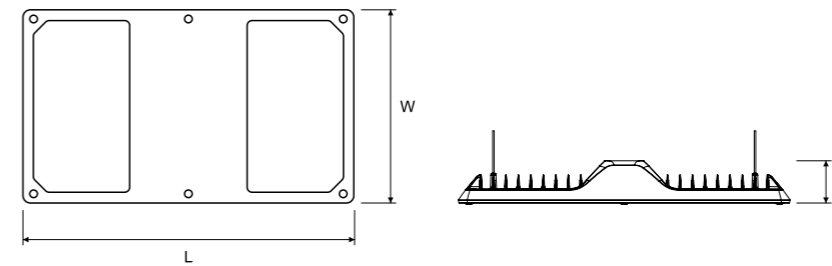

LIGHT BEAM CURVES

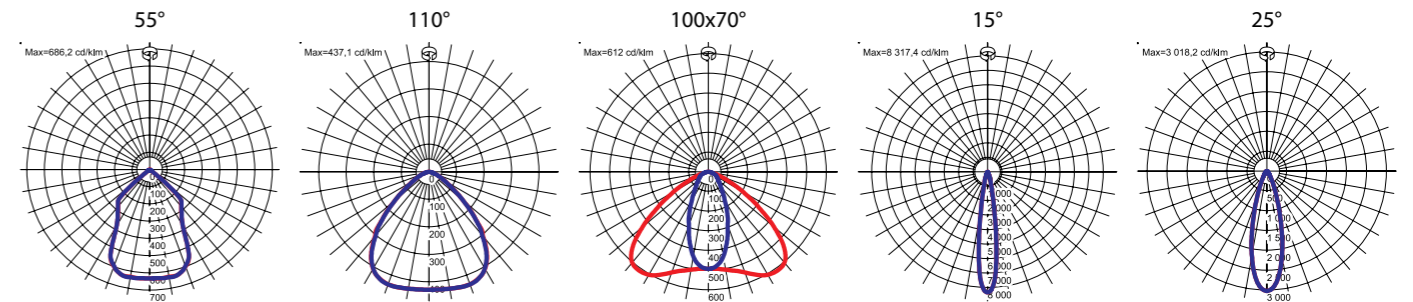

ACCESSORIES



Adjustable mounting bracket  
**150020.00821**  
e-number 43 390 78



Bracket for surface mounting  
**150020.00824**  
e-number 43 390 79



Frame for recessed mounting  
**150021.00917**  
e-number 43 390 80

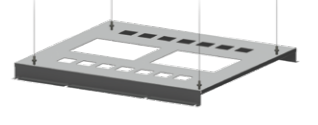

Suspended frame for connecting two CRUISER 2 LED or CRUISER 2 LB LED luminaires  
**150010.00973**  
e-number 43 390 81



Mounting bracket for hanging CRUISER 2 LED/CRUISER 2 LB LED luminaires on a cable  
**150020.00990**  
e-number 43 390 82



Mounting bracket for cable routes  
**150020.01137**



Mounting bracket for cable routes  
**150020.01138**

Industrial luminaire with LED light sources.



**TECHNICAL DATA**

**Mounting:** surface mounted, in the ceiling, with mounting frame (sold separately), suspended, on chains (on request), for hanging on a cable, with special mounting bracket (on request)

**Body:** high pressure die-cast aluminum

**Colour:** gray

**Diffuser:** tempered glass

**Power supply efficiency:** 90%

**ELECTRICAL DATA**

**Power:** 220-240V 50/60Hz

**Includes light source:** yes

**Type of equipment:** ON/OFF, DALI

**Electrical connection:** max 3x2,5 mm<sup>2</sup> wire, max 5x2,5 mm<sup>2</sup> wire

**Light distribution:** rotationally-symmetric, street

**OPTICAL DATA**

**Way of lighting:** direct

**Type of optic:** lens

**ULOR / DLOR:** 0/100

**GENERAL DATA**

**Lifetime (L80B10):** 100 000 h

**Additional information:** ball impact resistance. The possibility of using one or more power supplies in the luminaire.

**SDCM:** 5

**Warranty:** 5 years

**Application:** warehouses, logistics centers, industrial facilities, sport facilities, tunnels, roofing, outdoor mounting without roof on special request (index extension: .985)

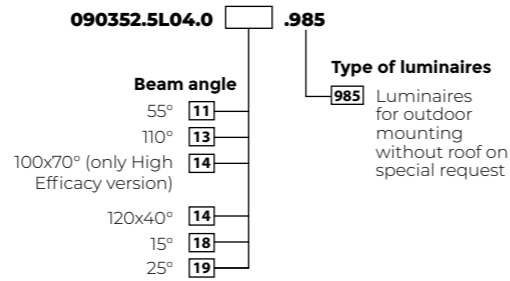

| Electrical number   | Code            | Type of equipment | Beam angle | (W) | (Lm)  | (lm/W) | (K)  | CRI/Ra | (°C)        |
|---|-----------------|-------------------|------------|-----|-------|--------|------|--------|-------------|
| <b>HIGH EFFICACY - beam angle: 55°, 110°, 100x70°, 15°, 25° (L675 W398 H90 mm, 11 kg)</b> |                 |                   |            |     |       |        |      |        |             |
| 43 391 37   | 090442.5L02.011 | ON/OFF            | 55         | 204 | 28400 | 139    | 4000 | ≥80    | -40 ... +45 |
| 43 391 38   | 090442.3L02.011 | DALI              | 55         | 204 | 28400 | 139    | 4000 | ≥80    | -40 ... +45 |
| 43 391 39   | 090442.5L02.013 | ON/OFF            | 110        | 204 | 28200 | 138    | 4000 | ≥80    | -40 ... +45 |
| 43 391 40   | 090442.3L02.013 | DALI              | 110        | 204 | 28200 | 138    | 4000 | ≥80    | -40 ... +45 |
| 43 391 41   | 090442.5L02.014 | ON/OFF            | 100x70     | 204 | 27750 | 136    | 4000 | ≥80    | -40 ... +45 |
| 43 391 42   | 090442.3L02.014 | DALI              | 100x70     | 204 | 27750 | 136    | 4000 | ≥80    | -40 ... +45 |

Also available in following colours

- Black (RAL 9005)
- White (RAL 9010)

**OTHER PICTURES**



Luminaire suspended on a cable with a special mounting bracket - bottom view



Luminaire suspended on a cable with a special mounting bracket - top view

**DIMENSIONAL DRAWING**

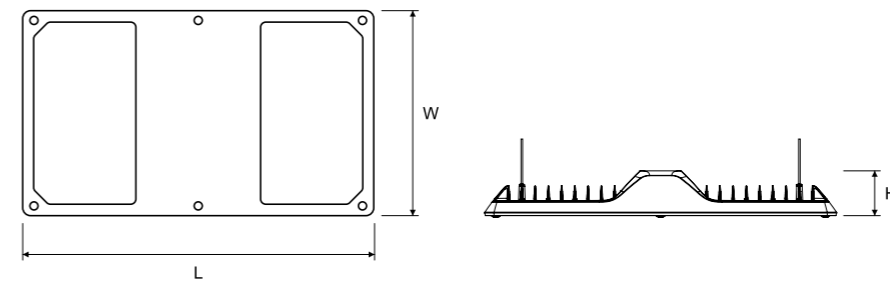

**LIGHT BEAM CURVES**

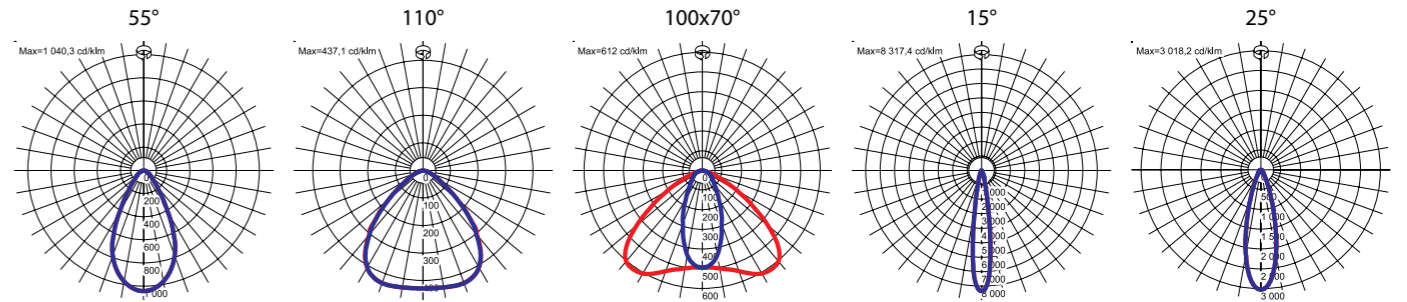

**ACCESSORIES**



Adjustable mounting bracket  
**150020.00823**  
e-number 43 390 86



Bracket for surface mounting  
**150020.00824**  
e-number 43 390 79

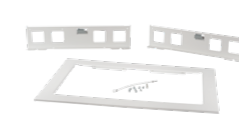

Frame for recessed mounting  
**150021.00918**  
e-number 43 390 83

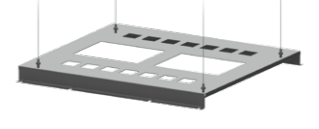

Suspended frame for connecting two CRUISER 2 PLUS LED or CRUISER 2 PLUS LB LED luminaires,  
**150010.00974**  
e-number 43 390 84



Mounting bracket for hanging CRUISER 2 PLUS LED/CRUISER 2 PLUS LB LED luminaires on a cable  
**150020.00991**  
e-number 43 390 85



Mounting bracket for cable routes  
**150020.01137**



Mounting bracket for cable routes  
**150020.01138**





Industrial luminaire for LED light sources.

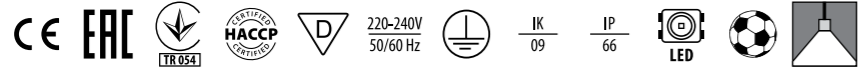

**TECHNICAL DATA**  
**Mounting:** suspended, with special mounting bracket (on request)  
**Body:** high pressure die-cast aluminum  
**Colour:** gray  
**Diffuser:** tempered glass

**ELECTRICAL DATA**  
**Power supply efficiency:** 90%  
**Power:** 220-240V 50/60Hz  
**Includes light source:** yes  
**Type of equipment:** ON/OFF, DALI  
**Electrical connection:** Wieland RST 3x2,5mm<sup>2</sup>, Wieland RST 5x2,5mm<sup>2</sup>

**OPTICAL DATA**  
**Light distribution:** symmetric, asymmetric  
**Way of lighting:** direct  
**Type of optic:** lens

**GENERAL DATA**  
**Lifetime (L80B10):** 100 000 h  
**Additional information:** ball impact resistance. The pole is not part of the luminaire.  
**SDCM:** 5  
**Warranty:** 5 years  
**Application:** warehouses, logistics centers, industrial facilities, sport facilities, outdoor mounting without roof



| Electrical number                               | Code            | Type of equipment | Beam angle        | (W) | (Lm)  | (lm/W) | (K)  | CRI/Ra | (°C)        |
|---|-----------------|-------------------|-------------------|-----|-------|--------|------|--------|-------------|
| <b>HIGH EFFICACY (L675 W398 H160 mm, 11 kg)</b> |                 |                   |                   |     |       |        |      |        |             |
|   | 090452.XL01.018 |                   | 15°               | 398 | 52200 | 131    | 4000 | ≥80    | -40 ... +35 |
|   | 090452.XL01.019 |                   | 25°               | 398 | 51000 | 128    | 4000 | ≥80    | -40 ... +35 |
|   | 090452.XL01.011 |                   | 55°               | 398 | 51000 | 128    | 4000 | ≥80    | -40 ... +35 |
|   | 090452.XL01.013 |                   | 110°              | 398 | 49900 | 125    | 4000 | ≥80    | -40 ... +35 |
|   | 090452.XL01.012 |                   | asymmetric-narrow | 398 | 50900 | 128    | 4000 | ≥80    | -40 ... +35 |
|   | 090452.XL01.015 |                   | asymmetric-wide   | 398 | 49300 | 124    | 4000 | ≥80    | -40 ... +35 |
|   | 090452.XL02.018 |                   | 15°               | 395 | 57450 | 145    | 4000 | ≥70    | -40 ... +35 |
|   | 090452.XL02.019 |                   | 25°               | 395 | 56100 | 142    | 4000 | ≥70    | -40 ... +35 |
|   | 090452.XL02.011 |                   | 55°               | 395 | 56100 | 142    | 4000 | ≥70    | -40 ... +35 |
|   | 090452.XL02.013 |                   | 110°              | 395 | 54900 | 139    | 4000 | ≥70    | -40 ... +35 |
|   | 090452.XL02.012 |                   | asymmetric-narrow | 395 | 56000 | 142    | 4000 | ≥70    | -40 ... +35 |
|   | 090452.XL02.015 |                   | asymmetric-wide   | 395 | 54200 | 137    | 4000 | ≥70    | -40 ... +35 |

090452.  .L01.18  
 5 Type of equipment ON/OFF  
 3 Type of equipment DALI

Also available in following colours  
 Black (RAL 9005)  
 White (RAL 9010)

OTHER PICTURES



DIMENSIONAL DRAWING

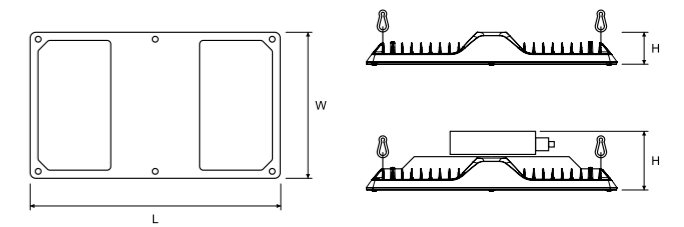

LIGHT BEAM CURVES

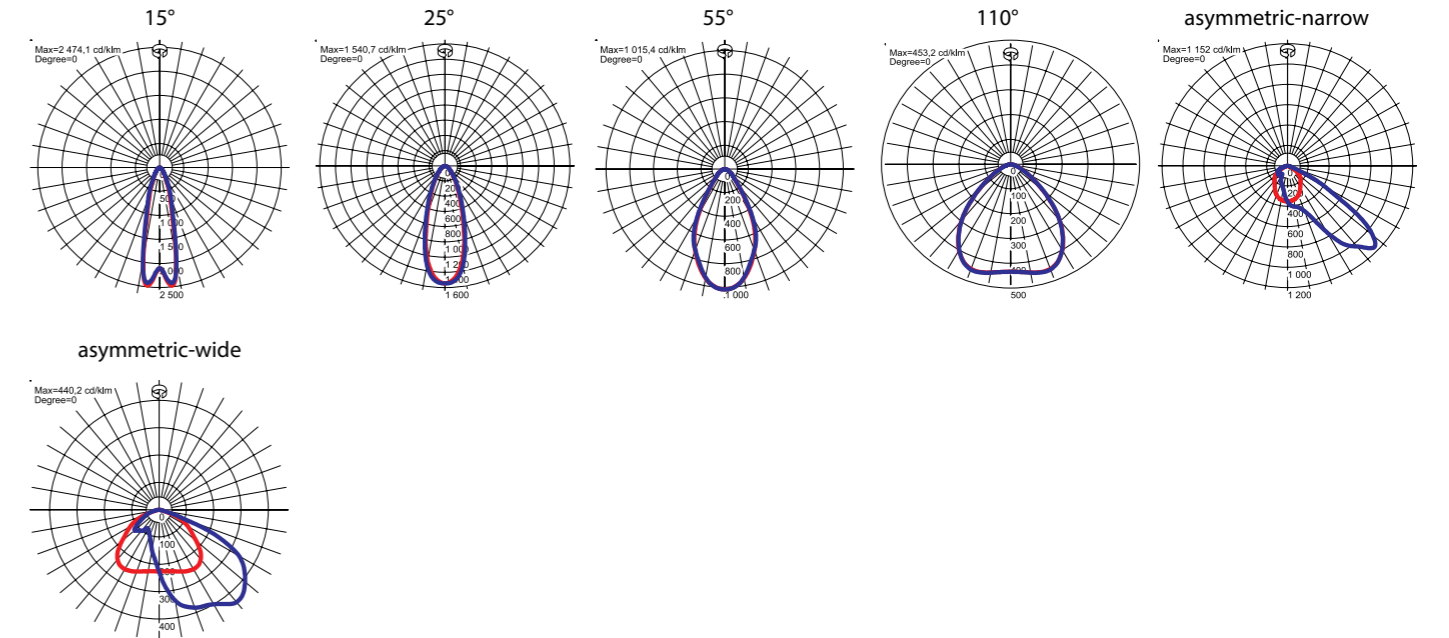

ACCESSORIES



Double mounting bracket, 100x1400x250  
**150020.01066**



Single mounting bracket, 100x560x250  
**150020.01073**



Extended, adjustable mounting bracket, 65x542x230  
**150022.01102**



Adjustable mounting bracket, 60x705x226  
**150020.00823**  
 Adjustable mounting bracket for mounting without roof, 60x705x226  
**150020.00955**



**CRUISER ARENA**  
(page 162)

Industrial luminaire designed to light up large-area objects. It is dedicated to use in applications requiring single pendant mounting.

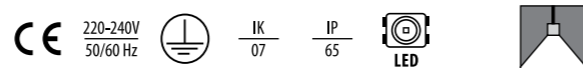

- TECHNICAL DATA** **Mounting:** suspended ceiling, wall  
**Body:** high pressure die-cast aluminum, plastic  
**Colour:** gray
- ELECTRICAL DATA** **Power supply efficiency:** 92%  
**Power:** 220-240V 50/60Hz  
**Includes light source:** yes  
**Type of equipment:** ON/OFF, DALI  
**Electrical connection:** max 3x2,5 mm<sup>2</sup> wire, max 3x2,5 mm<sup>2</sup> + 2x1,5 mm<sup>2</sup> wire
- OPTICAL DATA** **Way of lighting:** direct  
**Type of optic:** lens  
**ULOR / DLOR:** 0/100
- GENERAL DATA** **Lifetime (L80B10):** 100 000 h  
**Additional information:** luminaire equipped with a 1,5 m wire  
**SDCM:** 3  
**Warranty:** 5 years  
**Application:** warehouses, logistics centers, industrial facilities, production halls

| Electrical number                                 | Code            | Type of equipment | Beam angle | (W) | (Lm)  | (lm/W) | (K)  | CRI/Ra | (°C)        |
|---|-----------------|-------------------|------------|-----|-------|--------|------|--------|-------------|
| <b>275 mm (W275 H110/118 mm, 3,2 kg / 3,5 kg)</b> |                 |                   |            |     |       |        |      |        |             |
| 43 391 43   | 090492.5L01.111 | ON/OFF            | 60°        | 72  | 10550 | 147    | 4000 | ≥80    | -30 ... +50 |
| 43 391 44   | 090492.5L02.111 | ON/OFF            | 60°        | 96  | 13900 | 145    | 4000 | ≥80    | -30 ... +50 |
| 43 391 45   | 090492.5L03.111 | ON/OFF            | 60°        | 130 | 18200 | 140    | 4000 | ≥80    | -30 ... +50 |
| 43 391 46   | 090492.5L01.112 | ON/OFF            | 90°        | 72  | 11000 | 153    | 4000 | ≥80    | -30 ... +50 |
| 43 391 47   | 090492.5L02.112 | ON/OFF            | 90°        | 96  | 14450 | 151    | 4000 | ≥80    | -30 ... +50 |
| 43 391 48   | 090492.5L03.112 | ON/OFF            | 90°        | 130 | 18650 | 143    | 4000 | ≥80    | -30 ... +50 |
| 43 391 49   | 090492.5L01.113 | ON/OFF            | 120°       | 72  | 10900 | 151    | 4000 | ≥80    | -30 ... +50 |
| 43 391 50   | 090492.5L02.113 | ON/OFF            | 120°       | 96  | 14350 | 149    | 4000 | ≥80    | -30 ... +50 |
| 43 391 51   | 090492.5L03.113 | ON/OFF            | 120°       | 130 | 18750 | 144    | 4000 | ≥80    | -30 ... +50 |
| 43 391 43   | 090492.3L01.111 | DALI              | 60°        | 72  | 10550 | 147    | 4000 | ≥80    | -30 ... +50 |
| 43 391 44   | 090492.3L02.111 | DALI              | 60°        | 96  | 13900 | 145    | 4000 | ≥80    | -30 ... +50 |
| 43 391 45   | 090492.3L03.111 | DALI              | 60°        | 130 | 18200 | 140    | 4000 | ≥80    | -30 ... +50 |
| 43 391 46   | 090492.3L01.112 | DALI              | 90°        | 72  | 11000 | 153    | 4000 | ≥80    | -30 ... +50 |
| 43 391 47   | 090492.3L02.112 | DALI              | 90°        | 96  | 14450 | 151    | 4000 | ≥80    | -30 ... +50 |
| 43 391 48   | 090492.3L03.112 | DALI              | 90°        | 130 | 18650 | 143    | 4000 | ≥80    | -30 ... +50 |
| 43 391 49   | 090492.3L01.113 | DALI              | 120°       | 72  | 10900 | 151    | 4000 | ≥80    | -30 ... +50 |
| 43 391 50   | 090492.3L02.113 | DALI              | 120°       | 96  | 14350 | 149    | 4000 | ≥80    | -30 ... +50 |
| 43 391 51   | 090492.3L03.113 | DALI              | 120°       | 130 | 18750 | 144    | 4000 | ≥80    | -30 ... +50 |

090492.5L01.11

- Beam angle**
- 60° 1
  - 90° 2
  - 120° 3

Also available in following colours

- Black (RAL 9005)
- Graphite (RAL 7016)
- White (RAL 9010)
- All RAL colours

OTHER PICTURES



DALI



PC lampshade (275mm version only)

Aluminum lampshade (275mm version only)

DIMENSIONAL DRAWING

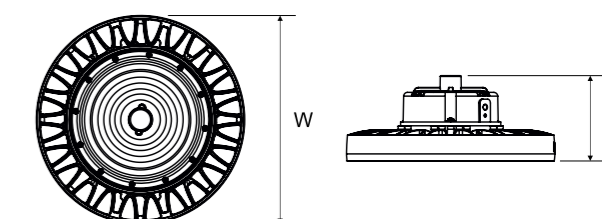

LIGHT BEAM CURVES

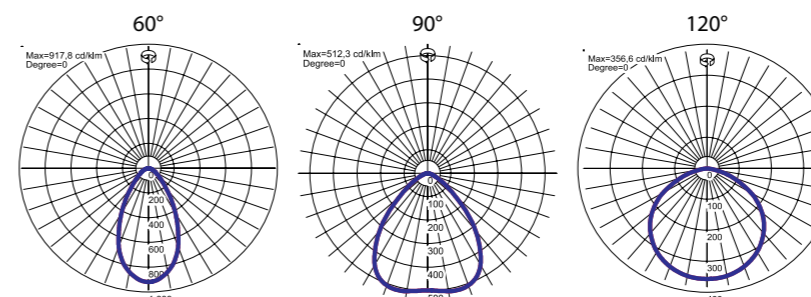

ACCESSORIES



Set of IP66/67 connectors  
150020.01074

PC lampshade  
150020.01071

Aluminum lampshade  
150020.01072

Adjustable mounting bracket TRITON LED ED  
150022.01112

Adjustable mounting bracket TRITON LED DALI  
150022.01114

Industrial luminaire designed to light up large-area objects. It is dedicated to use in applications requiring single pendant mounting.

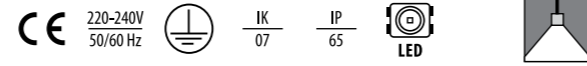

- TECHNICAL DATA** **Mounting:** suspended ceiling, wall
- Body:** high pressure die-cast aluminum, plastic
- Colour:** gray
- ELECTRICAL DATA** **Power supply efficiency:** 92%
- Power:** 220-240V 50/60Hz
- Includes light source:** yes
- Type of equipment:** ON/OFF, DALI
- Electrical connection:** max 3x2,5 mm<sup>2</sup> wire, max 3x2,5 mm<sup>2</sup> + 2x1,5 mm<sup>2</sup> wire
- OPTICAL DATA** **Way of lighting:** direct
- Type of optic:** lens
- ULOR / DLOR:** 0/100
- GENERAL DATA** **Lifetime (L80B10):** 100 000 h
- Additional information:** luminaire equipped with a 1,5 m wire
- SDCM:** 3
- Warranty:** 5 years
- Application:** warehouses, logistics centers, industrial facilities, production halls



**OTHER PICTURES**



**DIMENSIONAL DRAWING**

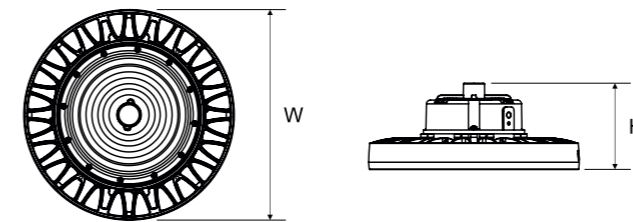

| Electrical number                         | Code            | Type of equipment | (W) | (Lm)  | (lm/W) | (K)  | CRI/Ra | (°C)        |
|---|-----------------|-------------------|-----|-------|--------|------|--------|-------------|
| <b>PLUS 370 mm (W370 H110 mm, 4,5 kg)</b> |                 |                   |     |       |        |      |        |             |
| 43 143 12                                 | 090492.5L07.212 | ON/OFF            | 148 | 24000 | 162    | 4000 | ≥80    | -30 ... +45 |
|   | 090492.3L07.21X | DALI              | 148 | 24000 | 162    | 4000 | ≥80    | -30 ... +45 |
|   | 090492.5L08.21X | ON/OFF            | 185 | 29500 | 159    | 4000 | ≥80    | -30 ... +40 |
|   | 090492.3L08.21X | DALI              | 185 | 29500 | 159    | 4000 | ≥80    | -30 ... +40 |
|   | 090492.5L09.21X | ON/OFF            | 221 | 34700 | 157    | 4000 | ≥80    | -25 ... +40 |
|   | 090492.3L09.21X | DALI              | 221 | 34700 | 157    | 4000 | ≥80    | -25 ... +40 |

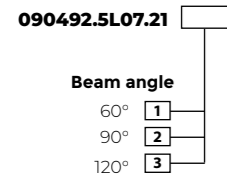

- Also available in following colours**
- Black (RAL 9005)
  - Graphite (RAL 7016)
  - White (RAL 9010)
  - All RAL colours

**LIGHT BEAM CURVES**

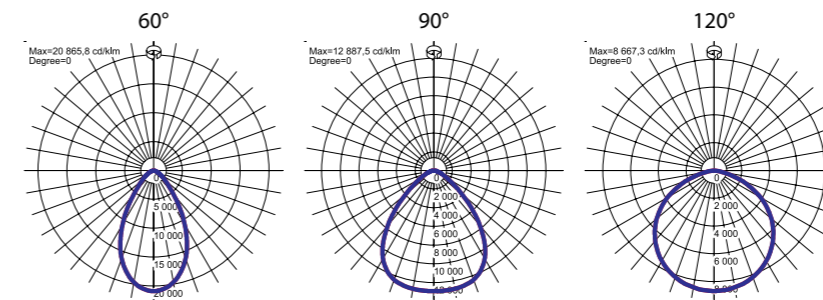

**ACCESSORIES**



Set of IP66/67 connectors  
**150020.01074**

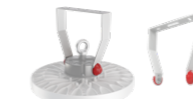

Adjustable mounting bracket  
TRITON LED PLUS version ED  
**150022.01113**



Adjustable mounting bracket  
TRITON LED PLUS version DALI  
**150022.01115**

High efficacy highbay luminaire is mainly used in industrial facilities, storage halls and other high spaces. Available 3 different sizes and up to 34 000lm.

- TECHNICAL DATA** **Mounting:** Suspended, Surface
- Body:** high pressure die-cast aluminum
- Colour:** black
- ELECTRICAL DATA** **Includes light source:** YES
- Type of equipment:** ON/OFF
- Electrical connection:** 1,5m cable, 3x1,0mm<sup>2</sup>
- OPTICAL DATA** **Type of optic:** lens
- Way of lighting:** direct
- GENERAL DATA** **Lifetime (L70B50):** 50 000 h
- SDCM:** 5
- Warranty:** 5 years



| Electrical number                         | (IP) | (W) | (Lm)  | (lm/W) | (K)  | CRI/Ra | (°C)         | Diameter / height (mm) |
|---|------|-----|-------|--------|------|--------|--------------|------------------------|
| <b>Highbay (2,2 kg / 2,4 kg / 3,7 kg)</b> |      |     |       |        |      |        |              |                        |
| 43 625 29                                 | IP65 | 100 | 13000 | 130    | 4000 | 80     | -30...+50 °C | 261/170                |
| 43 625 30                                 | IP65 | 151 | 19500 | 129    | 4000 | 80     | -30...+50 °C | 271/178                |
| 43 625 31                                 | IP65 | 240 | 34000 | 142    | 4000 | 80     | -30...+50 °C | 340/182                |

**ACCESSORIES**

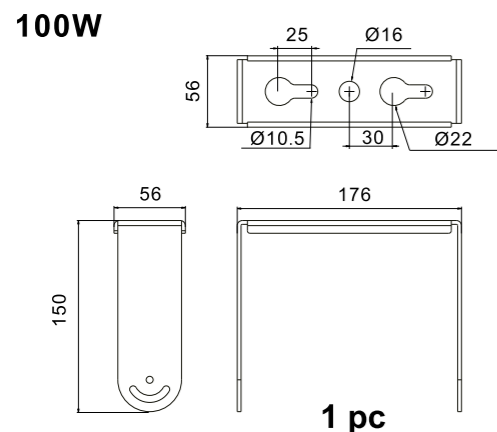

Mounting bracket for 100W Highbay  
e-number 43 143 10

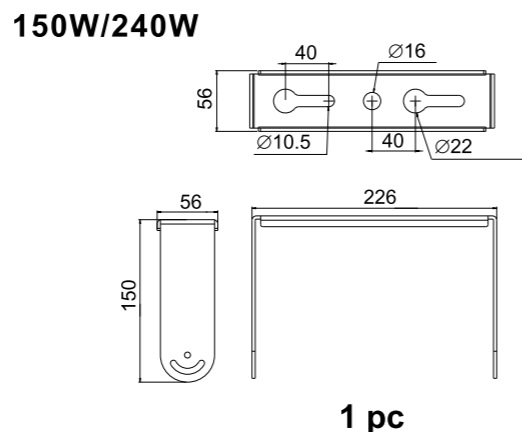

Mounting bracket for 151W & 240W Highbay  
e-number 43 143 11

**DIMENSIONAL DRAWING**

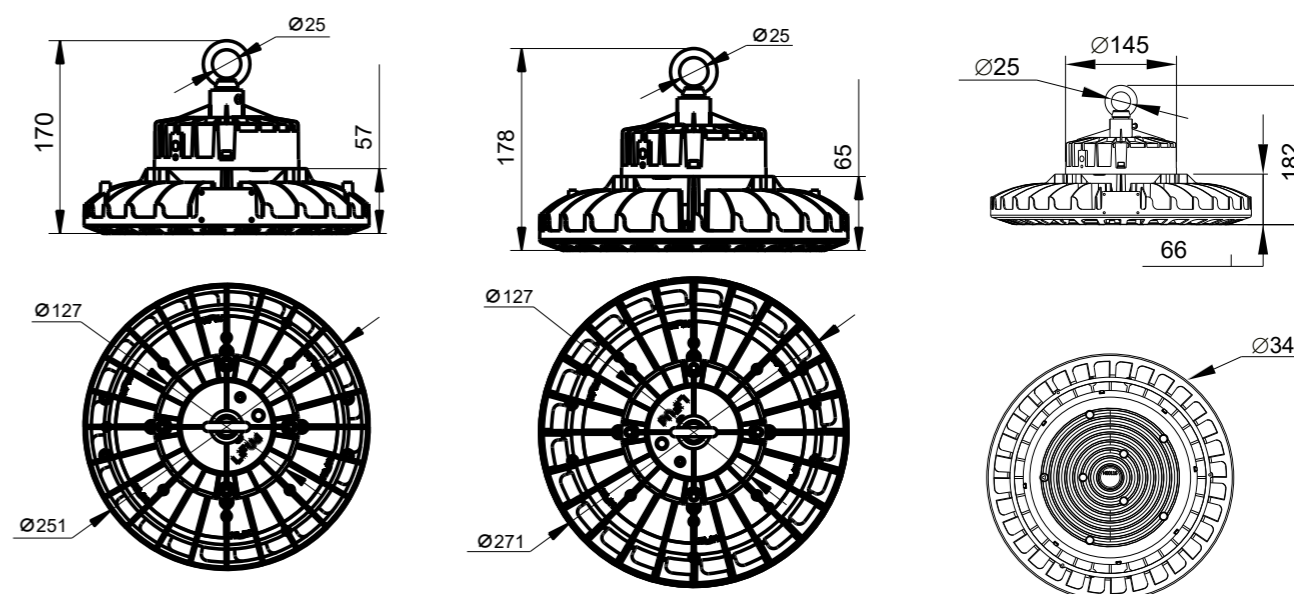

**LIGHT BEAM CURVES**

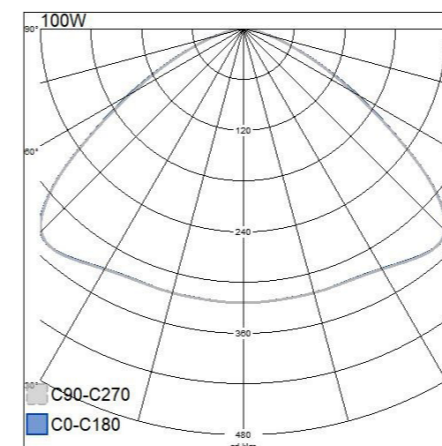



**SE7EN**  
(page 282)

**BOX**  
(page 174)

Box and Big Box are modern and decorative wall luminaires for outdoor use. Glare-free, dimmable and with stepless adjustable light distribution up/down. Square/Cube shape with compact dimensions. IP55, Class I. Dual cable entries on the back. Optional mounting frame for use with external cable are included. Heavy duty back and aluminium luminaire housing. Screen locking screw. Easy mounted with good connection space.

- TECHNICAL DATA** **Mounting:** wall
- Body:** aluminium
- Colour:** black, white
- ELECTRICAL DATA** **Includes light source:** YES
- Power:** 230V 50-60Hz
- Type of equipment:** triac dimming
- OPTICAL DATA** **Light distribution:** adjustable
- Way of lighting:** direct/indirect
- GENERAL DATA** **Lifetime (L70B50):** 50 000 h
- Available on request:** Big Box with 2 Schuko sockets
- SDCM:** 4
- Warranty:** 5 years

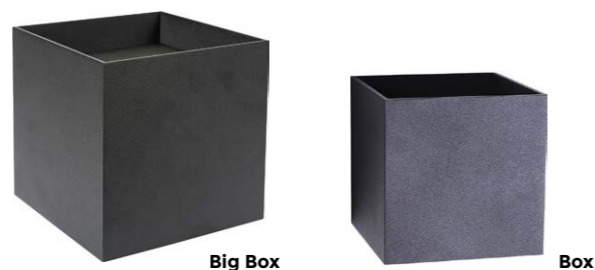

| Electrical number | Code    | Colour | (IP) | (W) | (Lm) | (lm/W) | (K)  | CRI/Ra | Beam angle | Width/height (mm) |
|-------------------|---------|--------|------|-----|------|--------|------|--------|------------|-------------------|
| <b>Box</b>        |         |        |      |     |      |        |      |        |            |                   |
| 45 425 22         | 3105852 | Black  | 55   | 2x3 | 410  | 68     | 3000 | 80     | Adjustable | 110/110           |
| 45 425 23         | 3105853 | White  | 55   | 2x3 | 410  | 68     | 3000 | 80     | Adjustable | 110/110           |
| 45 155 44         | 3105868 | Black  | 55   | 2x3 | 520  | 86     | 4000 | 80     | Adjustable | 110/110           |
| 45 155 45         | 3105869 | White  | 55   | 2x3 | 520  | 86     | 4000 | 80     | Adjustable | 110/110           |
| <b>Big Box</b>    |         |        |      |     |      |        |      |        |            |                   |
| 45 425 24         | 3100833 | Black  | 55   | 2x6 | 700  | 54     | 3000 | 80     | Adjustable | 163/160           |
| 45 425 25         | 3100834 | White  | 55   | 2x6 | 700  | 54     | 3000 | 80     | Adjustable | 163/160           |
| 45 425 26         | 3100836 | Black  | 55   | 2x6 | 810  | 68     | 4000 | 80     | Adjustable | 163/160           |
| 45 425 27         | 3100837 | White  | 55   | 2x6 | 810  | 68     | 4000 | 80     | Adjustable | 163/160           |

**OTHER PICTURES**



**DIMENSIONAL DRAWING**

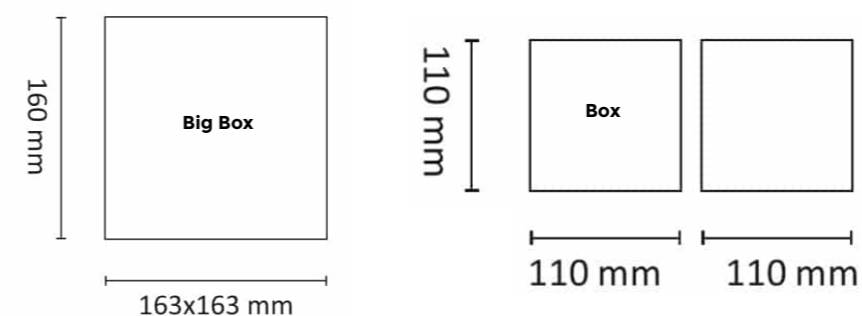

**LIGHT BEAM CURVES**

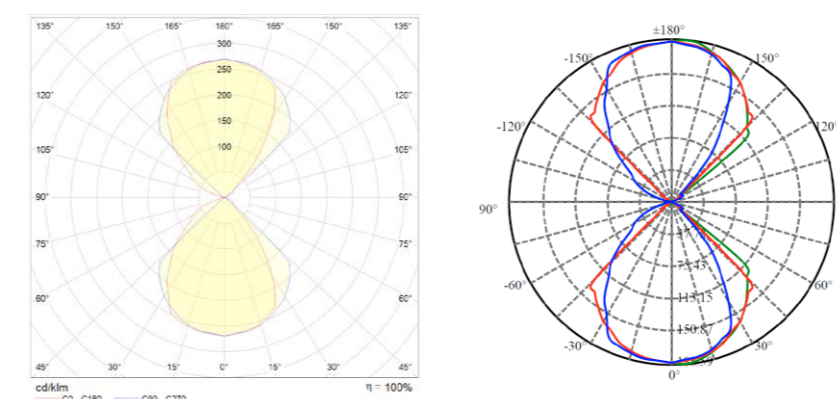



ARC dimmable wall fixtures in modern and timeless design with unique adjustable light distribution up and down. Integrated 2x3W LED. With quick connector between back and luminaire for easy installation. Arc is supplied with an optional wall bracket for surface mounted cable. 2 cable grommets in the back of luminaire. Material: Die-cast aluminium. Class II – IP55. Cable. Triac dimming.

**TECHNICAL DATA** **Mounting:** surface mounting  
**Body:** aluminium  
**Colour:** black, white

**ELECTRICAL DATA** **Includes light source:** YES  
**Power:** 230V 50-60Hz  
**Type of equipment:** triac dimming

**OPTICAL DATA** **Light distribution:** adjustable  
**Way of lighting:** direct

**GENERAL DATA** **Lifetime (L70B50):** 50 000 h  
**SDCM:** 4  
**Warranty:** 5 years



Black



White



| Electrical number | Code    | (IP) | (W) | (Lm) | (lm/W) | (K)  | CRI/Ra | Colour | Diameter/height (mm) |
|-------------------|---------|------|-----|------|--------|------|--------|--------|----------------------|
| <b>ARC</b>        |         |      |     |      |        |      |        |        |                      |
| 45 155 17         | 3105866 | 55   | 2x3 | 305  | 102    | 2700 | 80     | Black  | 125/110              |
| 45 155 18         | 3105867 | 55   | 2x3 | 305  | 102    | 2700 | 80     | White  | 125/110              |

**OTHER PICTURES**



**DIMENSIONAL DRAWING**

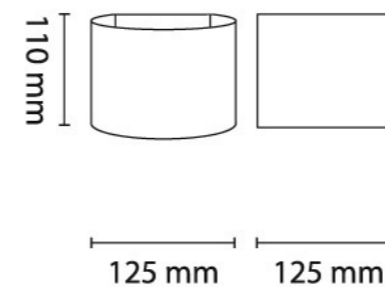

Kon is a compact, dimmable wall lamp with an exciting modern and timeless design. The luminaire has a unique function where the light distribution can be adjusted to your own request with four internal adjustable shields.

The luminaire has an integrated LED of 2x3W and lights up with brightness 305 lumens. Aluminium frame provides a solid and robust sense of quality. Kon is a popular favorite of consumers, designers and electricians. Kon may as well be used indoors as outdoors.

- TECHNICAL DATA** **Mounting:** wall  
**Body:** aluminium  
**Colour:** black, white
- ELECTRICAL DATA** **Includes light source:** YES  
**Power:** 230V 50-60Hz  
**Type of equipment:** triac dimming
- OPTICAL DATA** **Light distribution:** symmetric  
**Way of lighting:** direct/indirect
- GENERAL DATA** **Lifetime (L70B10):** 50 000 h  
**SDCM:** 4  
**Warranty:** 5 years



Black



White



| Electrical number | Code    | (IP) | (W) | (Lm) | (lm/W) | (K)  | CRI/Ra | Colour | Width/height/Depth (mm) |
|-------------------|---------|------|-----|------|--------|------|--------|--------|-------------------------|
| <b>Kon</b>        |         |      |     |      |        |      |        |        |                         |
| 45 155 19         | 3105864 | 55   | 2x3 | 305  | 102    | 2700 | 80     | Black  | 190/150/150             |
| 45 155 20         | 3105865 | 55   | 2x3 | 305  | 102    | 2700 | 80     | White  | 190/150/150             |

**OTHER PICTURES**



**DIMENSIONAL DRAWING**

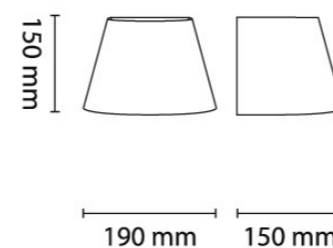

Edge is a low profile wall luminaire with one way light (1x6W) or up and down light (2x6W). Aluminium luminaire housing with tempered glass. 7-stage surface treatment for outdoor use. Integrated LED with built-in dimmable (Triac) LED driver. Dual cable entries and possible loop-wiring. The luminaires are supplied with an optional wall bracket for surface mounted cable. Material: Die-cast aluminium. Class I – IP55.

**TECHNICAL DATA** Mounting: wall  
Body: aluminium  
Colour: black, white

**ELECTRICAL DATA** Includes light source: YES  
Power: 230V 50-60Hz  
Type of equipment: triac dimming

**OPTICAL DATA** Light distribution: symmetric  
Way of lighting: direct

**GENERAL DATA** Lifetime (L70B50): 50 000 h  
SDCM: 4  
Warranty: 5 years



Black



White

| Electrical number | Code    | (W) | (Lm)  | (lm/W) | (K)  | CRI/Ra | Colour | Width/height/Depth (mm) |
|-------------------|---------|-----|-------|--------|------|--------|--------|-------------------------|
| <b>Edge</b>       |         |     |       |        |      |        |        |                         |
| 45 155 00         | 3109785 | 6   | 335   | 56     | 2700 | 80     | Black  | 215/105/32              |
| 45 155 01         | 3109786 | 6   | 335   | 56     | 2700 | 80     | White  | 215/105/32              |
|                   | 3109787 | 2x6 | 2x335 | 56     | 2700 | 80     | Black  | 215/105/32              |
|                   | 3109788 | 2x6 | 2x335 | 56     | 2700 | 80     | White  | 215/105/32              |

**OTHER PICTURES**



**DIMENSIONAL DRAWING**

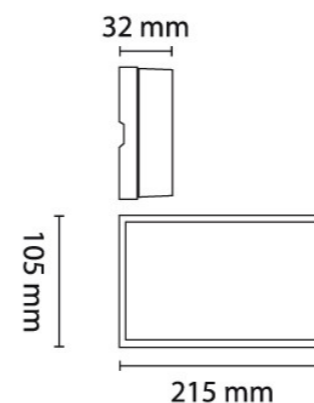

**LIGHT BEAM CURVES**

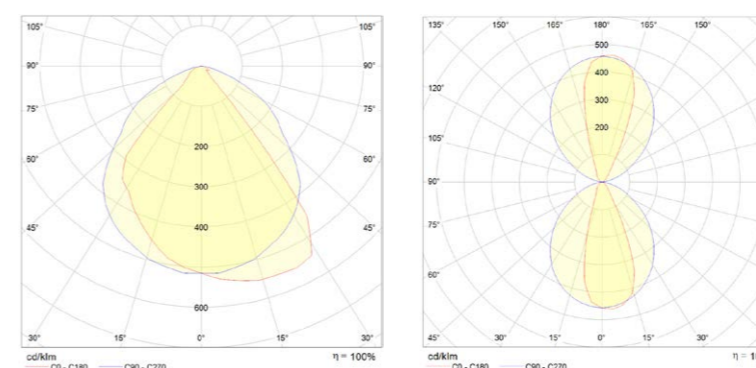



Case is a functional designed wall luminaire for use in e.g. balconies, walkways and at entrances. Case 1x12W has asymmetric light directed one way, Case 2x6W lights up and down, symmetric. The luminaire are powdercoated with a 7-stage surface treatment for outdoor use. Tempered glass. Integrated LED with built-in dimmable (Triac) LED driver. Dual cable entries and terminals for loop-wiring. Case luminaires are supplied with an optional wall bracket for surface mounted cable. Material: Die-cast aluminium. Class I – IP55.

Also available in 3000K and 4000K colour temperature.

- TECHNICAL DATA** **Mounting:** wall
- Body:** aluminium
- Colour:** black, white
- ELECTRICAL DATA** **Includes light source:** YES
- Power:** 230V 50-60Hz
- Type of equipment:** triac dimming
- OPTICAL DATA** **Light distribution:** symmetric, asymmetric
- Way of lighting:** direct
- GENERAL DATA** **Lifetime (L70B50):** 50 000 h
- SDCM:** 4
- Warranty:** 5 years



| Electrical number | Code    | Colour | (IP) | (IK) | (W) | (Lm) | (lm/W) | (K)  | CRI/Ra | Width/height/Depth (mm) |
|-------------------|---------|--------|------|------|-----|------|--------|------|--------|-------------------------|
| <b>Case</b>       |         |        |      |      |     |      |        |      |        |                         |
| 45 155 02         | 3109789 | Black  | 55   | 10   | 2x6 | 1140 | 79     | 2700 | 80     | 215/105/92              |
| 45 155 03         | 3109790 | White  | 55   | 10   | 2x6 | 1140 | 79     | 2700 | 80     | 215/105/92              |
| 45 155 04         | 3109791 | Black  | 55   | 10   | 12  | 1135 | 78     | 2700 | 80     | 215/105/92              |
| 45 155 05         | 3109792 | White  | 55   | 10   | 12  | 1135 | 78     | 2700 | 80     | 215/105/92              |

**PROJECTS**

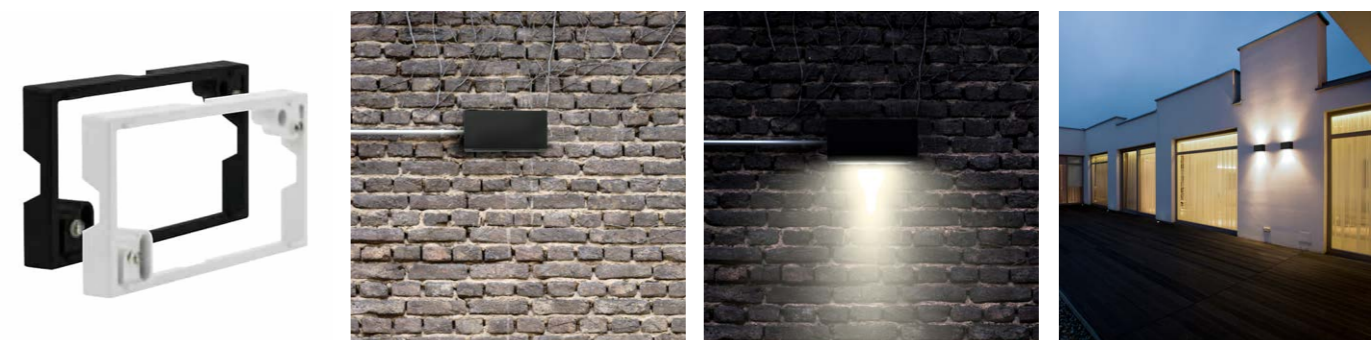

**DIMENSIONAL DRAWING**

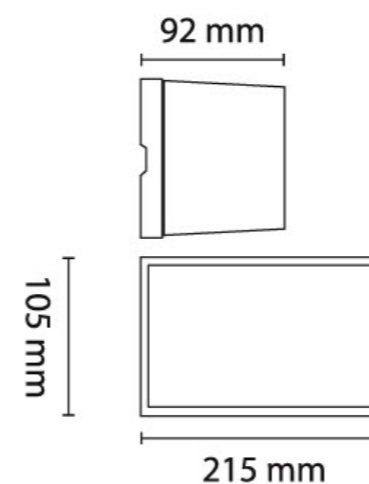

**LIGHT BEAM CURVES**

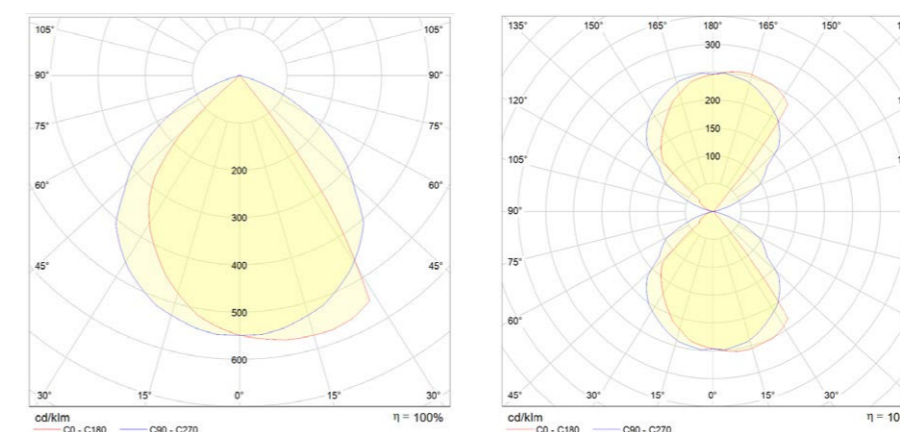

The Argos series are compact but sturdy cast aluminium wall lamps with tempered safety glass. Modern functional design, great finish and with a surface treatment that lasts. The products are surface treated with Unilamp's special ASC treatment for aggressive environments, that is, a 16 step process topped with special varnish. This makes the Argos range ideal for use in coastal areas and where there are environmental challenges.

Argos is available in a variety of configurations, with single or double direction of light, with asymmetric light distribution or with a wide and narrow beam of light. Argos can light up, down, or both and, making Argos a very versatile luminaire. Asymmetric variant not only provides light on the wall, but the light is also distributed beyond the courtyard.



- TECHNICAL DATA** Mounting: surface mounting  
Body: aluminium, tempered glass  
Colour: graphite, aluminium silver
- ELECTRICAL DATA** Includes light source: YES  
Power: 230V 50-60Hz  
Type of equipment: ON/OFF
- OPTICAL DATA** Light distribution: symmetric & asymmetric  
Way of lighting: direct
- GENERAL DATA** Lifetime (L70B50): 50 000 h  
SDCM: 3  
Warranty: 5 years







Graphite



Silver

| Electrical number | Code            | Light distribution | (IP) | (IK) | (W)   | (Lm) | (lm/W) | (K)  | CRI/Ra | Diameter/height (mm) |
|-------------------|-----------------|--------------------|------|------|-------|------|--------|------|--------|----------------------|
| <b>Argos</b>      |                 |                    |      |      |       |      |        |      |        |                      |
| 45 154 00         | 3105880         | Symmetric          | 65   | 9    | 5,2   | 387  | 74     | 3000 | 80     | 225/90/107           |
| 45 154 01         | 3105884         | Asymmetric         | 65   | 9    | 5,2   | 387  | 74     | 3000 | 80     | 225/90/107           |
| 45 154 02         | 3105888         | Asymmetric         | 65   | 9    | 14    | 956  | 68     | 3000 | 80     | 225/90/107           |
| 45 154 03         | 3109580         | Asymmetric         | 65   | 9    | 14    | 956  | 68     | 4000 | 80     | 225/90/107           |
| 45 154 05         | 3105882         | Asymmetric         | 65   | 9    | 2x5,2 | 387  | 74     | 3000 | 80     | 225/90/107           |
| 45 154 06         | 3105886         | Symmetric          | 65   | 9    | 2x5,2 | 387  | 74     | 3000 | 80     | 225/90/107           |
| 45 174 48         | 5401-9-3-922-02 | Asymmetric         | 65   | 9    | 5,2   | 440  | 62     | 4000 | 80     | 225/90/107           |
| 45 174 49         | 5401-0-3-830-02 | Asymmetric         | 65   | 9    | 5,2   | 440  | 62     | 4000 | 80     | 225/90/107           |
| 45 174 50         | 5405-9-3-922-02 | Graphite           | 65   | 9    | 2x5,2 | 440  | 62     | 4000 | 80     | 225/90/107           |

**Also available in following colours**

-  Black (RAL 9005)
-  Graphite (RAL 7016)
-  Dark Grey (RAL 7037)
-  Aluminium Silver (RAL 9006)
-  White (RAL 9010)

**OTHER PICTURES**

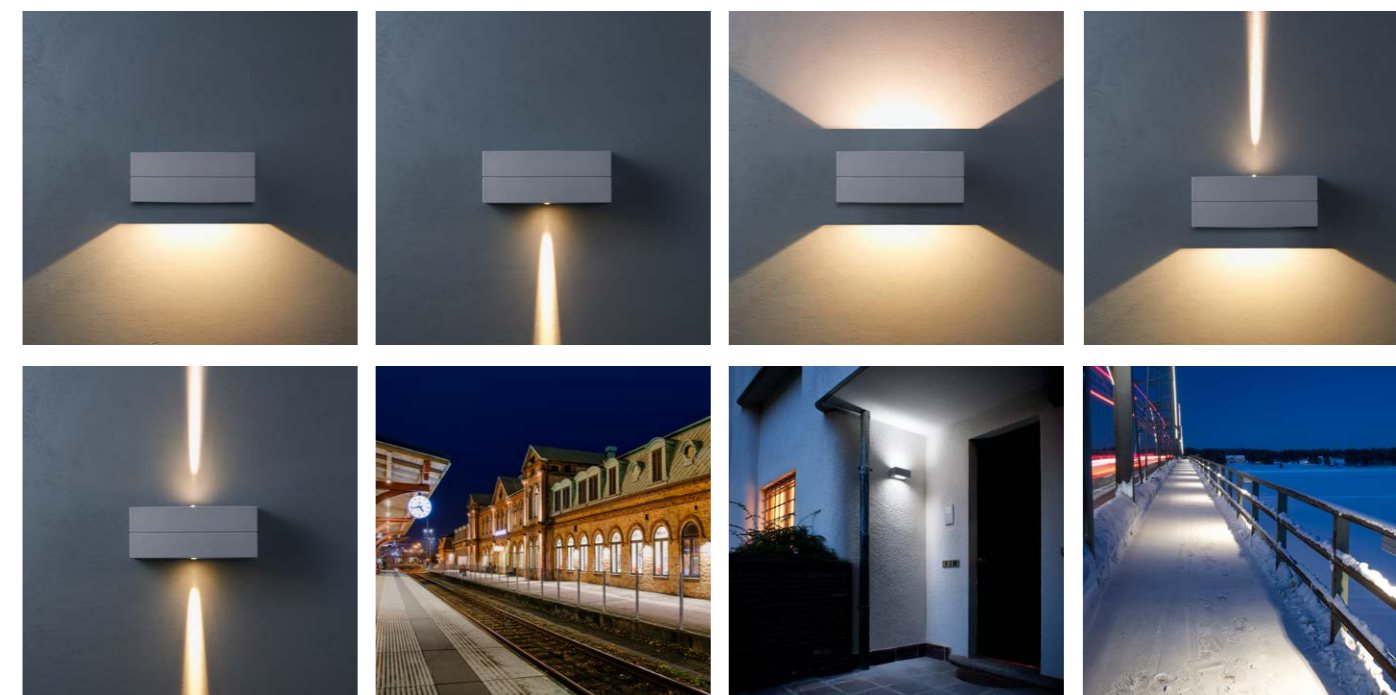

**DIMENSIONAL DRAWING**

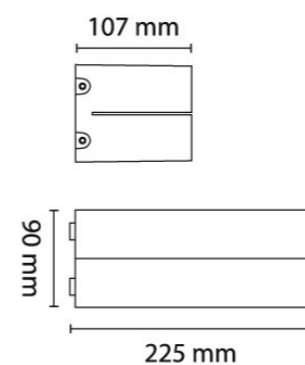

**LIGHT BEAM CURVES**

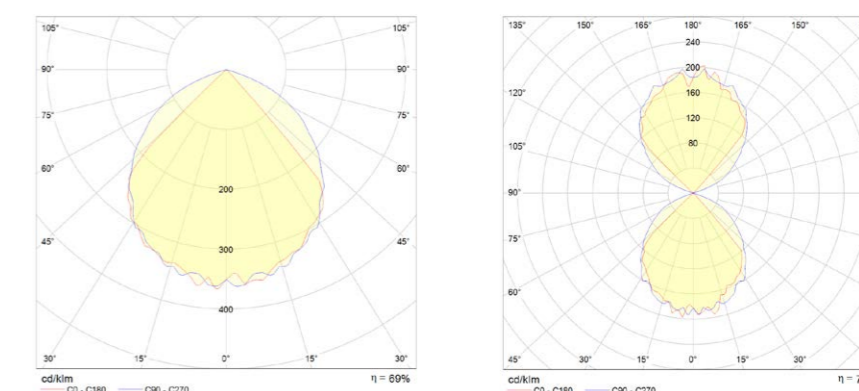

**LIGHT BEAM CURVES**

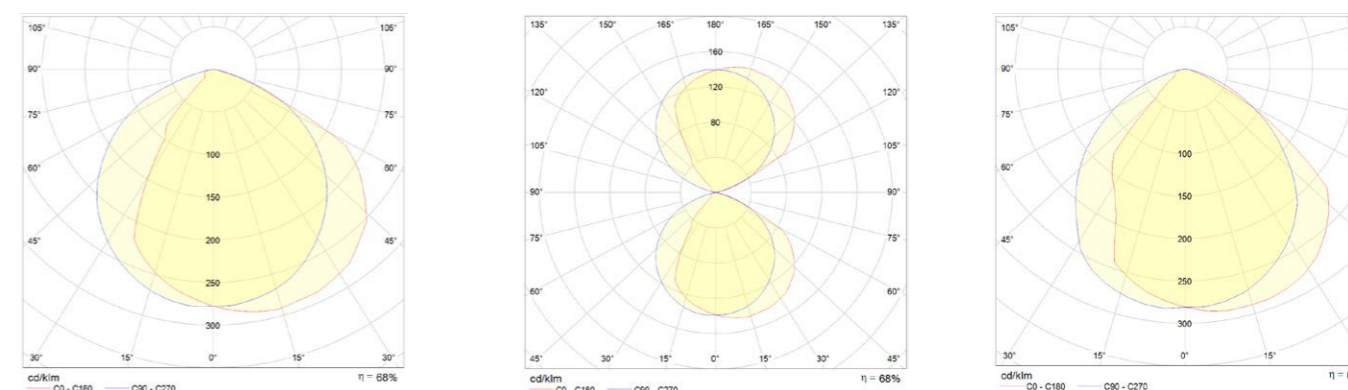



The Bronco is a compact, narrow wall lamp in die-cast aluminium with tempered safety glass. Bronco uses modern lensing technique that enables a directed and exact light distribution. The luminaire is available in several different configurations, with single or double direction of light, with asymmetric and narrow beam of light. The Bronco comes in variants that can light up, down, or both and, making the Bronco a very versatile luminaire. Asymmetric variant not only provides light on the wall, but the light is also distributed beyond the courtyard.

Bronco is surface treated with Unilamp's special ASC treatment for aggressive environments, that is, a 16 step process topped with special varnish. This makes the Bronco ideal for use in coastal areas and areas with environmental challenges. The Bronco comes with integrated LED with built-in LED driver. Not dimmable.

Also available in 4000K colour temperature.

|                        |  |
|------------------------|--|
| <b>TECHNICAL DATA</b>  | <b>Mounting:</b> surface mounting                |
|                        | <b>Body:</b> aluminium                           |
|                        | <b>Colour:</b> graphite                          |
| <b>ELECTRICAL DATA</b> | <b>Includes light source:</b> YES                |
|                        | <b>Power:</b> 230V 50-60Hz                       |
|                        | <b>Type of equipment:</b> ON/OFF                 |
| <b>OPTICAL DATA</b>    | <b>Light distribution:</b> symmetric, asymmetric |
|                        | <b>Way of lighting:</b> direct                   |
| <b>GENERAL DATA</b>    | <b>Lifetime (L70B50):</b> 50 000 h               |
|                        | <b>SDCM:</b> 3                                   |
|                        | <b>Warranty:</b> 5 years                         |



| Electrical number | Code    | Light distribution  | (W) | (Lm)  | (lm/W) | (K)  | (IP) | (IK) | CRI/Ra | Width/height/Depth (mm) |
|-------------------|---------|---------------------|-----|-------|--------|------|------|------|--------|-------------------------|
| <b>Bronco</b>     |         |                     |     |       |        |      |      |      |        |                         |
| 45 154 10         | 3109800 | downlight narrow    | 12  | 910   | 75     | 3000 | 65   | 10   | 80     | 68/180/125              |
| 45 154 11         | 3109803 | narrow / asymmetric | 21  | 2x960 | 86     | 3000 | 65   | 10   | 80     | 68/180/125              |
| 45 154 12         | 3109808 | narrow / narrow     | 21  | 2x960 | 86     | 3000 | 65   | 10   | 80     | 68/180/125              |

**Also available in following colours**

- Black (RAL 9005)
- Graphite (RAL 7016)
- Dark Grey (RAL 7037)
- Aluminium Silver (RAL 9006)
- White (RAL 9010)

**PROJECTS**

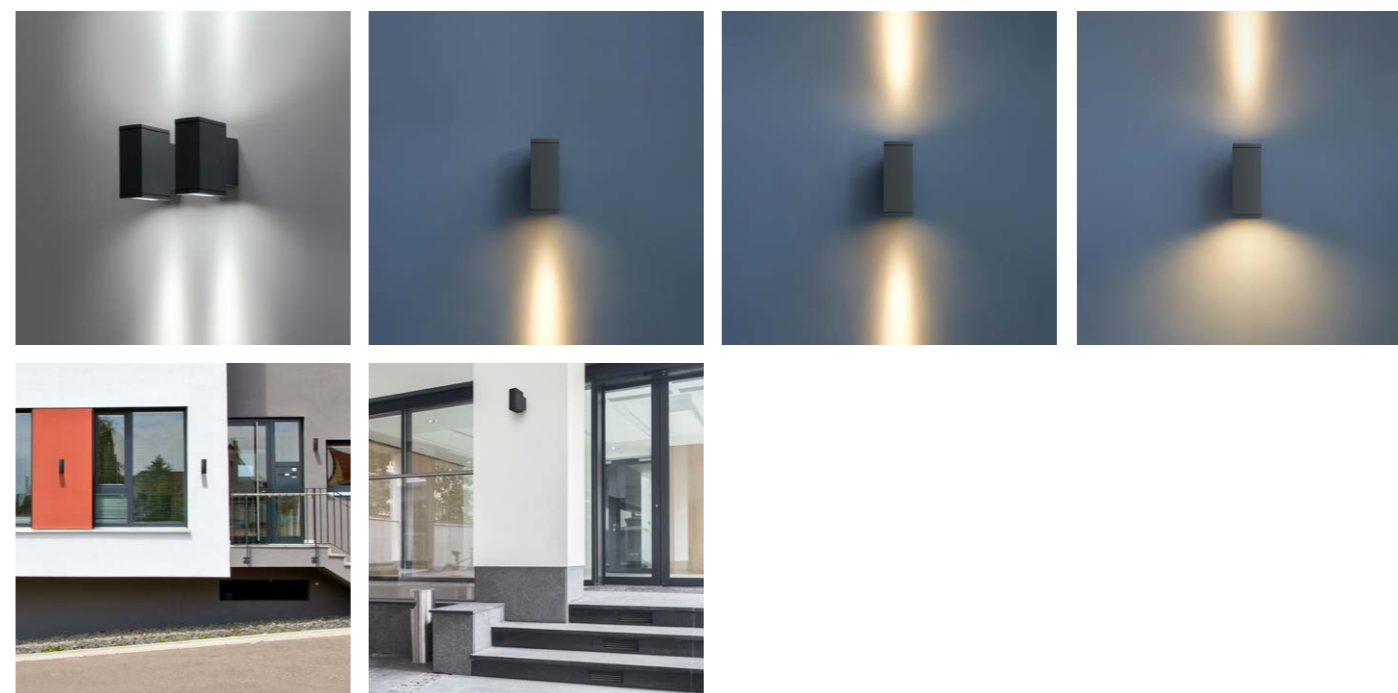

**DIMENSIONAL DRAWING**

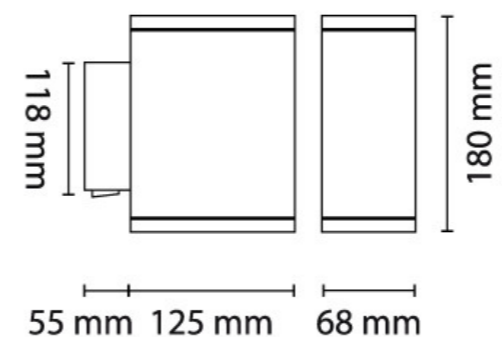

**LIGHT BEAM CURVES**

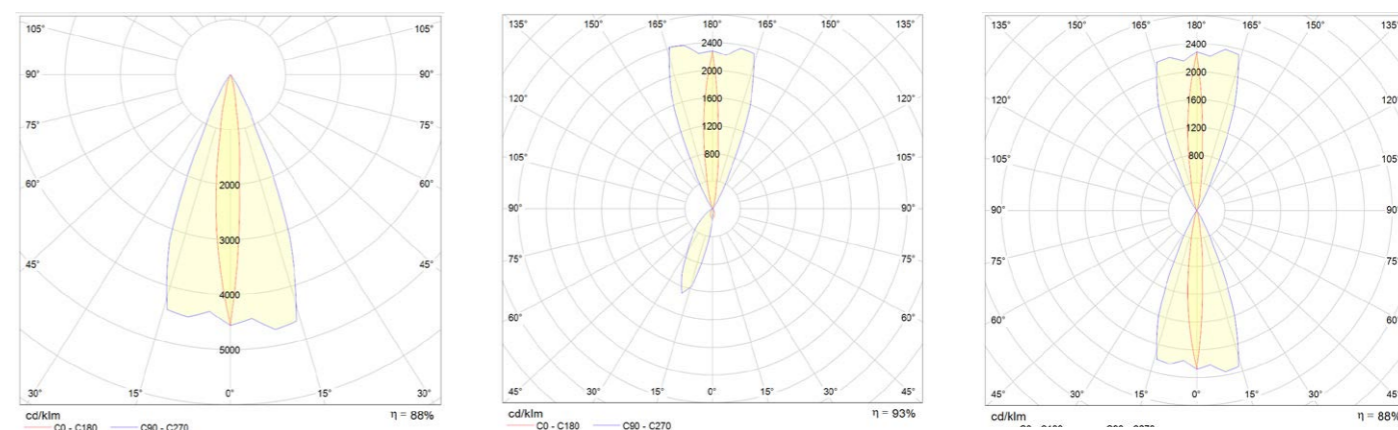



Tube Mini our smallest size in the Tube family. Specially treated for outdoor use. Tube Wall direct Mini are great for lighting up facades and walking areas in private environment. Tube Ceiling is a versatile outdoor downlight. All models comes with integrated COB LED module with integrated LED drivers and with several different light distributions, symmetric and asymmetric. The reflector can be swapped for other beam angles on the symmetrical variants. Various mounting details can be supplied as accessories. Tube Mini is not dimmable. Material: Die-cast aluminium with tempered safety glass. Class I – IP65.

- TECHNICAL DATA**  
Mounting: ceiling, wall  
Body: high pressure die-cast aluminium  
Colour: graphite  
Diffuser: tempered glass (IK7)
- ELECTRICAL DATA**  
Includes light source: YES  
Power: 230V 50-60Hz  
Type of equipment: ON/OFF
- OPTICAL DATA**  
Light distribution: symmetric (also available in asymmetric)  
Way of lighting: direct
- GENERAL DATA**  
Lifetime (L70B10): 50 000 h  
SDCM: 3  
Warranty: 5 years



Ceiling



Wall



| Electrical number | Code            | (IP) | (W) | (Lm) | (lm/W) | Beam angle | (K)  | CRI | Diameter/height (mm) |
|-------------------|-----------------|------|-----|------|--------|------------|------|-----|----------------------|
| <b>Ceiling</b>    |                 |      |     |      |        |            |      |     |                      |
| 45 174 93         | 4001-6-3-901-02 | 65   | 15  | 1610 | 102    | 26         | 3000 | 80  | 105/192              |
| 45 174 94         | 4001-7-3-901-02 | 65   | 15  | 1460 | 97     | 42         | 3000 | 80  | 105/192              |
| 45 174 95         | 4001-6-3-904-02 | 65   | 15  | 1640 | 107    | 26         | 4000 | 80  | 105/192              |
| 45 174 96         | 4001-7-3-904-02 | 65   | 15  | 1490 | 97     | 42         | 4000 | 80  | 105/192              |

| Electrical number  | Code            | (IP) | (W) | (Lm)   | (lm/W) | Beam angle | (K)  | CRI | Diameter/depth/height (mm) |
|--------------------|-----------------|------|-----|--------|--------|------------|------|-----|----------------------------|
| <b>Wall direct</b> |                 |      |     |        |        |            |      |     |                            |
| 45 174 51          | 3109463         | 65   | 13  | 855    |        | 26         | 3000 | 80  | 105/160/199                |
| 45 174 52          | 5004-6-3-904-02 | 65   | 15  | 1640   | 109    | 26         | 4000 | 80  | 105/160/199                |
| 45 174 53          | 5004-7-3-901-02 | 65   | 15  | 1460   | 97     | 42         | 3000 | 80  | 105/160/199                |
| 45 174 54          | 5004-7-3-904-02 | 65   | 15  | 1490   | 99     | 42         | 4000 | 80  | 105/160/199                |
| 45 174 57          | 5001-7-3-901-02 | 65   | 28  | 2x1460 | 104    | 42         | 3000 | 80  | 105/174/202                |
| 45 174 56          | 5001-6-3-904-02 | 65   | 28  | 2x1640 | 117    | 26         | 4000 | 80  | 105/174/202                |
| 45 174 58          | 5001-7-3-904-02 | 65   | 28  | 2x1490 | 106    | 42         | 4000 | 80  | 105/174/202                |
| 45 154 64          | 3109460         | 65   | 28  | 2x1610 | 115    | 26         | 3000 | 80  | 105/174/202                |

Also available in following colours

- Black (RAL 9005)
- Graphite (RAL 7016)
- Dark Grey (RAL 7037)
- Aluminium Silver (RAL 9006)
- White (RAL 9010)

OTHER PICTURES

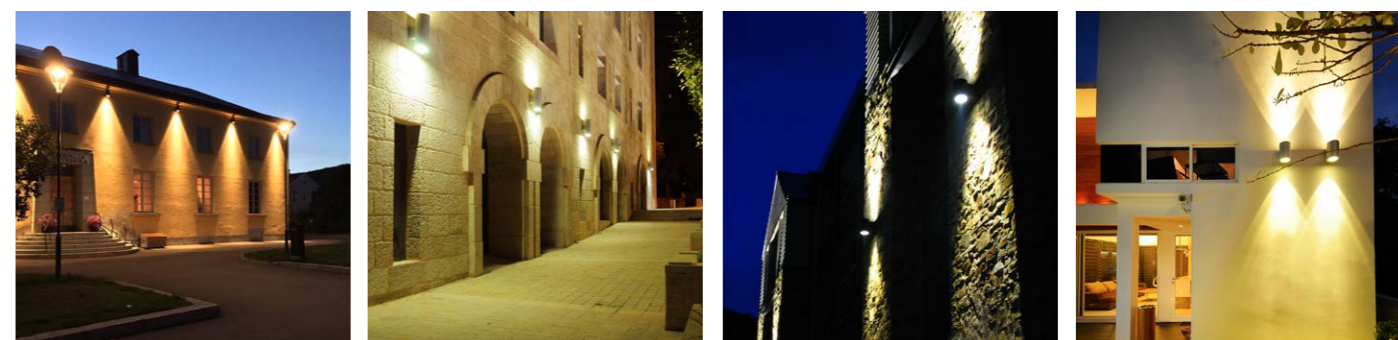

DIMENSIONAL DRAWING

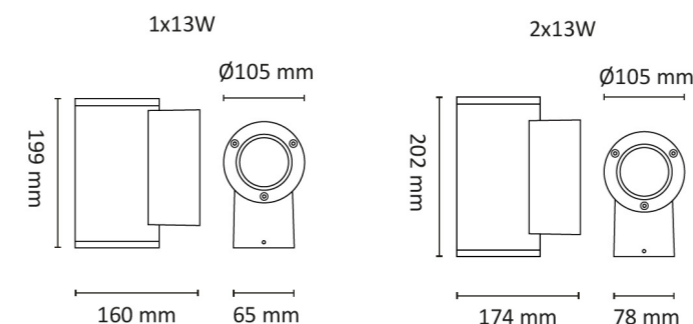

LIGHT BEAM CURVES

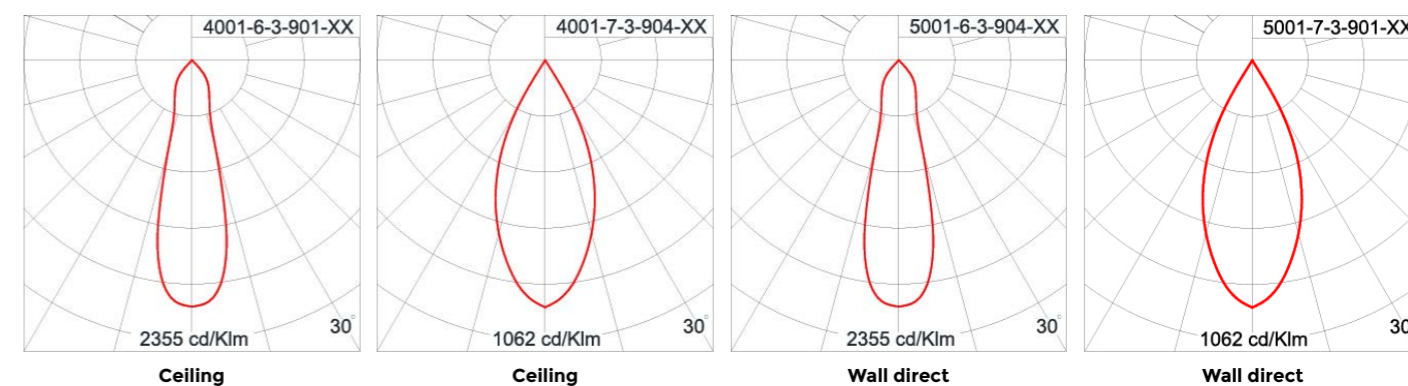

Tube Wall Medium is our middle size in the Tube family. Specially treated for outdoor use. Tube Wall Medium is great for lighting up facades and walking areas in a private and public environment. Comes with integrated COB LED module with integrated LED drivers and with several different light distributions, symmetric and asymmetric. The reflector can be swapped for other beam angles on the symmetrical variants. Various mounting details can be supplied as accessories. Tube Wall Medium is not dimmable. Material: Die-cast aluminium with tempered safety glass. Class I – IP65.

- TECHNICAL DATA**  
Mounting: ceiling, wall  
Body: high pressure die-cast aluminium  
Colour: graphite
- ELECTRICAL DATA**  
Diffuser: tempered glass (IK7)  
Includes light source: YES  
Power: 230V 50-60Hz  
Type of equipment: ON/OFF
- OPTICAL DATA**  
Light distribution: symmetric, asymmetric  
Way of lighting: direct, direct/indirect
- GENERAL DATA**  
Lifetime (L70B10): 50 000 h  
SDCM: 3  
Warranty: 5 years



Graphite

Silver

| Electrical number  | Code            | Colour   | (IP) | (IK) | (W) | (Lm)   | (lm/W) | Beam angle | (K)  | CRI | Diameter/depth/height (mm) |
|--------------------|-----------------|----------|------|------|-----|--------|--------|------------|------|-----|----------------------------|
| <b>Tube Medium</b> |                 |          |      |      |     |        |        |            |      |     |                            |
| 45 154 36          | 3109610         | Graphite | 65   | 10   | 19  | 1840   | 96     | asym       | 3000 | 80  | 140/200/200                |
| 45 154 38          | 3109680         | Graphite | 65   | 10   | 19  | 1880   | 98     | asym       | 4000 | 80  | 140/200/200                |
| 45 154 39          | 3109612         | Graphite | 65   | 10   | 37  | 2x1840 | 99     | asym       | 3000 | 80  | 140/200/302                |
| 45 154 65          | 5005-7-3-902-02 | Graphite | 65   | 10   | 19  | 1800   | 94     | 43         | 3000 | 80  | 140/200/200                |
| 45 154 66          | 3109464         | Graphite | 65   | 10   | 19  | 1840   | 96     | 19         | 3000 | 80  | 140/200/200                |
| 45 174 61          | 5005-9-3-902-02 | Graphite | 65   | 10   | 19  | 1840   | 96     | asym       | 3000 | 80  | 140/200/200                |
| 45 174 62          | 5005-6-3-905-02 | Graphite | 65   | 10   | 19  | 1890   | 99     | 19         | 4000 | 80  | 140/200/200                |
| 45 174 63          | 5005-7-3-905-02 | Graphite | 65   | 10   | 19  | 1840   | 96     | 43         | 4000 | 80  | 140/200/200                |
| 45 174 64          | 5005-9-3-905-02 | Graphite | 65   | 10   | 19  | 1880   | 98     | asym       | 4000 | 80  | 140/200/200                |
| 45 174 65          | 3109461         | Graphite | 65   | 10   | 37  | 2x1840 | 99     | 19         | 3000 | 80  | 140/200/302                |
| 45 174 66          | 5002-7-3-902-02 | Graphite | 65   | 10   | 37  | 2x1800 | 97     | 43         | 3000 | 80  | 140/200/302                |
| 45 174 67          | 5002-9-3-902-02 | Graphite | 65   | 10   | 37  | 2x1840 | 99     | asym       | 3000 | 80  | 140/200/302                |
| 45 174 68          | 5002-6-3-905-02 | Graphite | 65   | 10   | 37  | 2x1854 | 102    | 19         | 4000 | 80  | 140/200/302                |
| 45 174 69          | 5002-7-3-905-02 | Graphite | 65   | 10   | 37  | 2x1800 | 97     | 43         | 4000 | 80  | 140/200/302                |
| 45 174 70          | 5002-9-3-905-02 | Graphite | 65   | 10   | 37  | 2x1880 | 101    | asym       | 4000 | 80  | 140/200/302                |

Also available in following colours

- Black (RAL 9005)
- Graphite (RAL 7016)
- Dark Grey (RAL 7037)
- Aluminium Silver (RAL 9006)
- White (RAL 9010)

OTHER PICTURES



DIMENSIONAL DRAWING

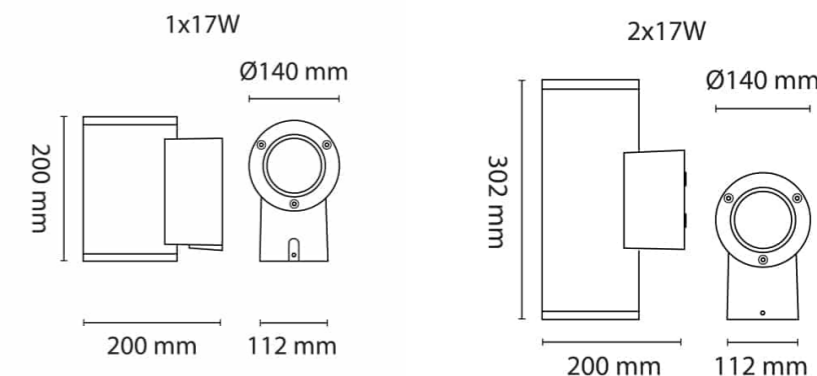

LIGHT BEAM CURVES

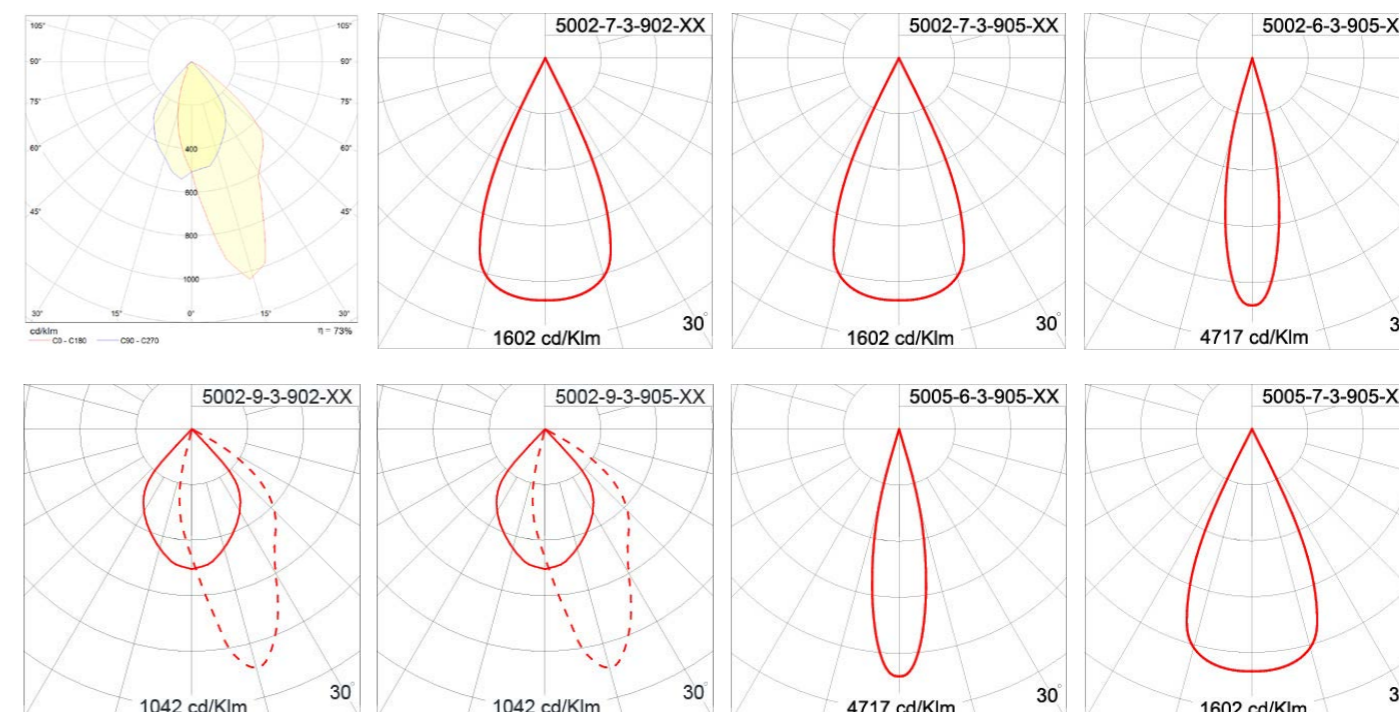

ACCESSORIES

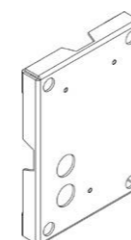

e-number 45 154 45  
3109890  
Tube Medium accessory



e-number 45 154 44  
3109687  
Tube Medium angle accessory



e-number 45 154 43  
3109686  
Tube Medium accessory

Tube Maxi is the largest luminaire in the Tube family, specially treated for outdoor use and is great for lighting up large areas and facades in both the private and public environment. The luminaires comes with integrated COB LED module with integrated LED drivers and with different light distributions. Symmetric and asymmetric. Reflector can be swapped for other beam angles on the symmetrical models. The Tube Maxi series is not dimmable. Class I – IP65. Material: Die-cast aluminium with tempered safety glass.

Some combinations of colors and light colors are produced to order.



**TECHNICAL DATA** Mounting: ceiling, wall, recessed  
Body: high pressure die-cast aluminium  
Colour: graphite

**ELECTRICAL DATA** Includes light source: YES  
Power: 230V 50-60Hz

**OPTICAL DATA** Type of equipment: ON/OFF  
Light distribution: symmetric, asymmetric  
Way of lighting: direct, direct/indirect

**GENERAL DATA** Lifetime (L70B10): 50 000 h  
SDCM: 3  
Warranty: 5 years



| Electrical number | Code            | (IP) | (W) | (Lm) | (lm/W) | Beam angle | (K)  | CRI | Diameter/height (mm) |
|-------------------|-----------------|------|-----|------|--------|------------|------|-----|----------------------|
| <b>Ceiling</b>    |                 |      |     |      |        |            |      |     |                      |
| 45 175 01         | 4003-6-3-887-02 | 65   | 23  | 2460 | 107    | 19°        | 3000 | 80  | 175/262              |
| 45 175 02         | 4003-7-3-887-02 | 65   | 23  | 2410 | 105    | 43°        | 3000 | 80  | 175/262              |
| 45 175 03         | 4003-6-3-891-02 | 65   | 23  | 2520 | 110    | 19°        | 4000 | 80  | 175/262              |
| 45 175 04         | 4003-7-3-891-02 | 65   | 23  | 2480 | 108    | 43°        | 4000 | 80  | 175/262              |

| Electrical number  | Code            | (IP) | (W) | (Lm) | (lm/W) | Beam angle | (K)  | CRI | Diameter/depth/height (mm) |
|--------------------|-----------------|------|-----|------|--------|------------|------|-----|----------------------------|
| <b>Wall direct</b> |                 |      |     |      |        |            |      |     |                            |
| 45 174 37          | 5006-9-3-905-02 | 65   | 36  | 3130 | 87     | asym       | 4000 | 80  | 175/248/269                |
| 4 5154 40          | 3109620         | 65   | 38  | 3490 | 92     | asym       | 3000 | 80  | 175/248/269                |
| 45 174 41          | 5006-9-3-891-02 | 65   | 23  | 2100 | 91     | asym       | 4000 | 80  | 175/248/269                |
| 45 174 43          | 5006-6-3-891-02 | 65   | 23  | 2520 | 110    | 19°        | 4000 | 80  | 175/248/269                |
| 45 174 44          | 5006-7-3-891-02 | 65   | 23  | 2480 | 108    | 43°        | 4000 | 80  | 175/248/269                |
| 45 174 73          | 5006-7-3-905-02 | 65   | 36  | 3530 | 98     | 43°        | 4000 | 80  | 175/248/269                |
| 45 174 76          | 5006-5-3-905-02 | 65   | 36  | 3950 | 110    | 12°        | 4000 | 80  | 175/248/269                |
| 45 174 77          | 5006-6-3-905-02 | 65   | 36  | 3530 | 98     | 19°        | 4000 | 80  | 175/248/269                |

|                             |                 |    |      |        |     |          |      |    |             |
|-----------------------------|-----------------|----|------|--------|-----|----------|------|----|-------------|
| <b>Wall direct/indirect</b> |                 |    |      |        |     |          |      |    |             |
| 45 174 39                   | 5003-7-3-891-02 | 65 | 2x23 | 2x2480 | 108 | 43°      | 4000 | 80 | 175/248/450 |
| 45 174 40                   | 5003-9-3-891-02 | 65 | 2x23 | 2x2100 | 91  | sym/asym | 4000 | 80 | 175/248/450 |
| 45 174 42                   | 5003-6-3-891-02 | 65 | 2x23 | 2x2520 | 110 | 19°      | 4000 | 80 | 175/248/450 |
| 45 154 91                   | 5003-6-3-905-02 | 65 | 2x34 | 2x3530 | 104 | 19°      | 4000 | 80 | 175/248/450 |
| 45 154 92                   | 5003-7-3-905-02 | 65 | 2x34 | 2x3480 | 102 | 43°      | 4000 | 80 | 175/248/450 |
| 45 154 93                   | 5003-9-3-905-02 | 65 | 2x34 | 2x3130 | 92  | sym/asym | 4000 | 80 | 175/248/450 |
| 45 154 42                   | 3109622         | 65 | 2x36 | 2x3475 | 97  | sym/asym | 3000 | 80 | 175/248/450 |

| Electrical number | Code            | (IP) | (W) | (Lm) | (lm/W) | Beam angle | (K)  | CRI | Diameter/height (mm) |
|-------------------|-----------------|------|-----|------|--------|------------|------|-----|----------------------|
| <b>Recessed</b>   |                 |      |     |      |        |            |      |     |                      |
| 45 175 05         | 4003-7-3-877-02 | 65   | 30  | 1850 | 62     | 47°        | 3000 | 80  | 235/310              |
| 45 175 06         | 4003-7-3-878-02 | 65   | 30  | 1950 | 65     | 47°        | 4000 | 80  | 235/310              |

Also available in following colours

- Black (RAL 9005)
- Graphite (RAL 7016)
- Dark Grey (RAL 7037)
- Aluminium Silver (RAL 9006)
- White (RAL 9010)

OTHER PICTURES



DIMENSIONAL DRAWING

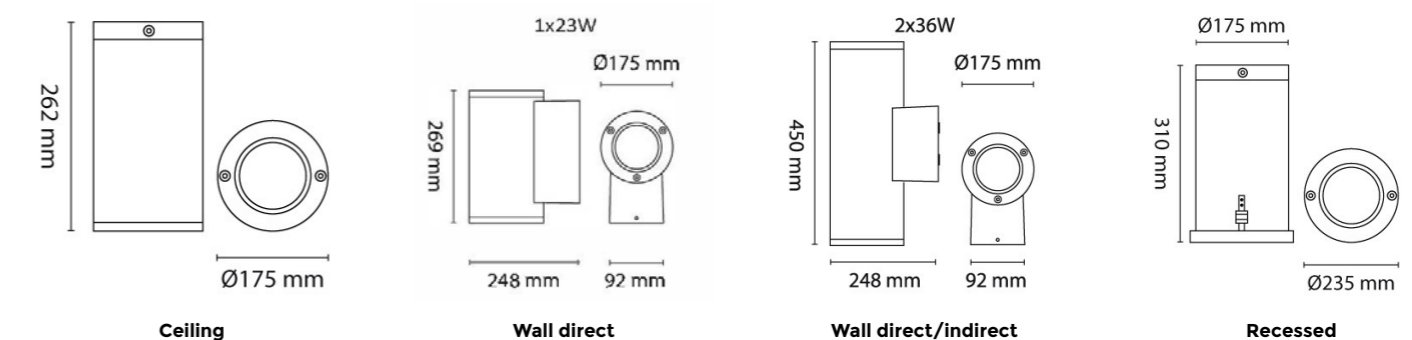

LIGHT BEAM CURVES

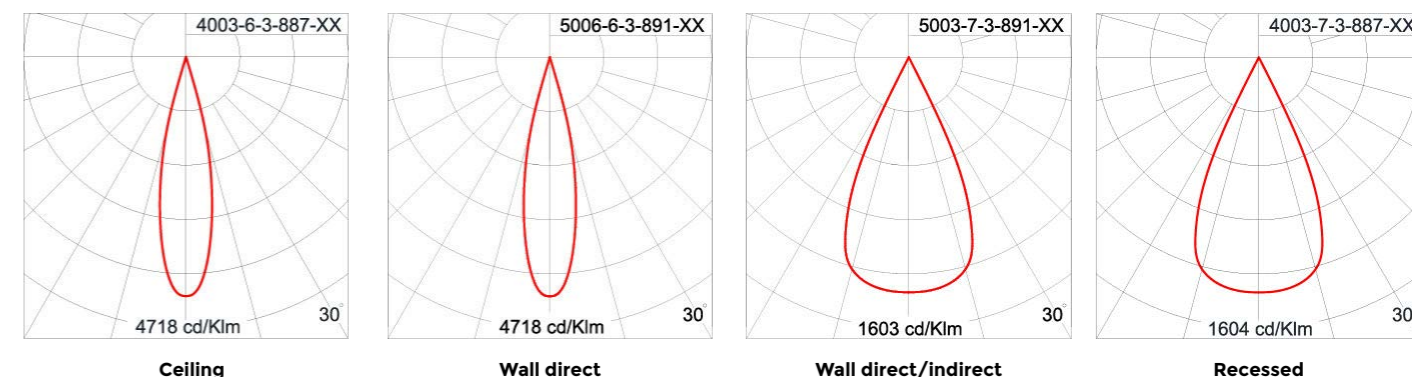

A/s Eidsvaag Fabrikker

**TUBE MAXI**  
(page 197)

The RAM luminaire provides a clearly delimited light beam which is perfect for making light patterns illuminating garage doors, windows, as well as frames. It may also be used to create exciting patterns in corridors etc. A true special luminaire for the creative light designer. Ram is not dimmable. Stylish design and solid construction for indoor and outdoor use.

**TECHNICAL DATA** **Mounting:** ceiling  
**Body:** aluminium  
**Colour:** black, white

**ELECTRICAL DATA** **Includes light source:** YES  
**Power:** 230V 50-60Hz  
**Type of equipment:** ON/OFF

**OPTICAL DATA** **Light distribution:** symmetric  
**Way of lighting:** direct

**GENERAL DATA** **Lifetime (L70B10):** 50 000 h  
**SDCM:** 3  
**Warranty:** 5 years



Black



White



| Electrical number | Code    | (IP) | (W) | (Lm) | (lm/W) | (K)  | CRI | Colour | Width/height/depth (mm) |
|-------------------|---------|------|-----|------|--------|------|-----|--------|-------------------------|
| <b>RAM</b>        |         |      |     |      |        |      |     |        |                         |
| 45 155 31         | 3109635 | 55   | 6   | 400  | 67     | 3000 | 80  | Black  | 120/63/65               |
| 45 155 35         | 3109636 | 55   | 6   | 400  | 67     | 3000 | 80  | White  | 120/63/65               |

**OTHER PICTURES**

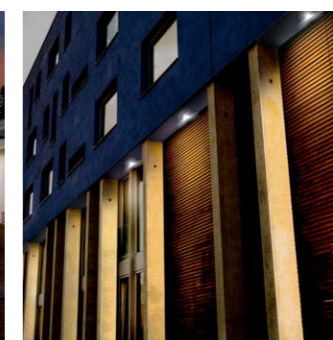

**DIMENSIONAL DRAWING**

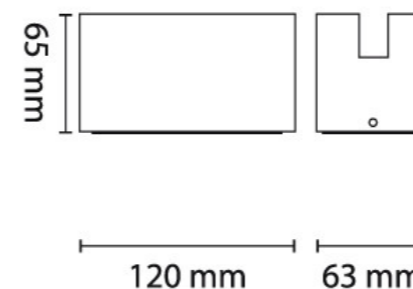

The Zouk family are orientation luminaire with very compact dimensions and very sleek to the wall. It gives the impression of semi-recessed. Zouk models are ideal where you do not want, or have the opportunity to make savings in the wall. Cable/tube input from the rear of the luminaire. Very good shielding for glare-free light. Specially treated for outdoor use. Integrated LED with built-in LED driver. Recommended mounting height: 25-50 cm from floor/ground. Not dimmable. The wall bracket for the outside cable is supplied as an accessory Material: Die-cast aluminium. Class I – IP65.

**TECHNICAL DATA** Mounting: wall  
Body: high pressure die-cast aluminium  
Colour: graphite, silver, white

**ELECTRICAL DATA** Includes light source: YES  
Power: 230V 50-60Hz  
Type of equipment: ON/OFF

**OPTICAL DATA** Light distribution: symmetric  
Way of lighting: direct

**GENERAL DATA** Lifetime (L70B10): 50 000 h  
SDCM: 3  
Warranty: 5 years



| Electrical number | Code            | (IP) | (W) | (Lm) | (lm/W) | (K)  | CRI | Colour   | Width/height/depth (mm) |
|-------------------|-----------------|------|-----|------|--------|------|-----|----------|-------------------------|
| <b>Zouk 1</b>     |                 |      |     |      |        |      |     |          |                         |
| 45 154 46         | 3109640         | 65   | 9   | 333  | 37     | 3000 | 80  | Graphite | 235/85/32               |
| 45 154 47         | 3109641         | 65   | 9   | 333  | 37     | 3000 | 80  | Silver   | 235/85/32               |
| 45 154 48         | 3109642         | 65   | 9   | 333  | 37     | 3000 | 80  | White    | 235/85/32               |
| 45 174 05         | 7052-0-3-939-06 | 65   | 9   | 380  | 38     | 4000 | 80  | White    | 235/85/32               |
| 45 174 35         | 7052-0-3-939-02 | 65   | 9   | 380  | 38     | 4000 | 80  | Graphite | 235/85/32               |
| 45 174 36         | 7052-0-3-939-04 | 65   | 9   | 380  | 38     | 4000 | 80  | Silver   | 235/85/32               |

| Electrical number | Code            | (IP) | (W) | (Lm) | (lm/W) | (K)  | CRI | Colour   | Width/height/depth (mm) |
|-------------------|-----------------|------|-----|------|--------|------|-----|----------|-------------------------|
| <b>Zouk 2</b>     |                 |      |     |      |        |      |     |          |                         |
| 45 154 49         | 3109645         | 65   | 9   | 335  | 37     | 3000 | 80  | Graphite | 235/235/32              |
| 45 154 50         | 3109646         | 65   | 9   | 335  | 37     | 3000 | 80  | Silver   | 235/235/32              |
| 45 154 51         | 3109647         | 65   | 9   | 335  | 37     | 3000 | 80  | White    | 235/235/32              |
| 45 154 75         | 7053-0-3-939-02 | 65   | 9   | 385  | 39     | 4000 | 80  | Graphite | 235/235/32              |
| 45 154 76         | 7053-0-3-939-04 | 65   | 9   | 385  | 39     | 4000 | 80  | Silver   | 235/235/32              |
| 45 154 77         | 7053-0-3-939-06 | 65   | 9   | 385  | 39     | 4000 | 80  | White    | 235/235/32              |

| Electrical number | Code            | (IP) | (W) | (Lm) | (lm/W) | (K)  | CRI | Colour   | Diameter/depth (mm) |
|-------------------|-----------------|------|-----|------|--------|------|-----|----------|---------------------|
| <b>Zouk 3</b>     |                 |      |     |      |        |      |     |          |                     |
| 45 154 52         | 3109810         | 65   | 11  | 440  | 40     | 3000 | 80  | Graphite | 240/36              |
| 45 154 53         | 3109811         | 65   | 11  | 440  | 40     | 3000 | 80  | Silver   | 240/36              |
| 45 154 54         | 3109812         | 65   | 11  | 440  | 40     | 3000 | 80  | White    | 240/36              |
| 45 154 78         | 7054-0-3-939-02 | 65   | 11  | 490  | 44     | 4000 | 80  | Graphite | 240/36              |
| 45 154 79         | 7054-0-3-939-04 | 65   | 11  | 490  | 44     | 4000 | 80  | Silver   | 240/36              |
| 45 154 80         | 7054-0-3-939-06 | 65   | 11  | 490  | 44     | 4000 | 80  | White    | 240/36              |

**Also available in following colours**

- Black (RAL 9005)
- Graphite (RAL 7016)
- Dark Grey (RAL 7037)
- Aluminium Silver (RAL 9006)
- White (RAL 9010)

**OTHER PICTURES**



**DIMENSIONAL DRAWING**

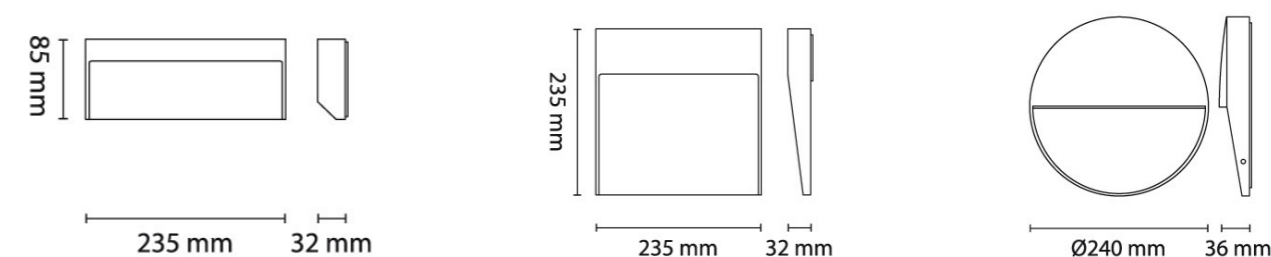

**LIGHT BEAM CURVES**

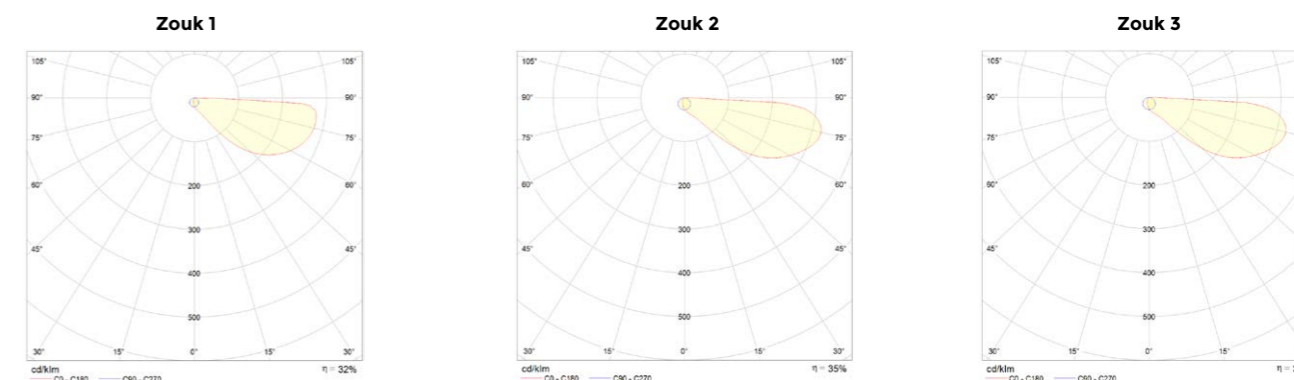

**ACCESSORIES**

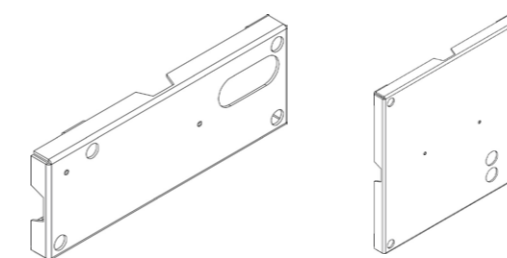

e-number 45 154 55  
3109870  
Graphite

e-number 45 154 56  
3109875  
Graphite



Lolite Round is a series of external, dimmable orientation luminaires with very compact dimensions. Lolite is ideal where you do not want, nor have the ability to recess the luminaire into the wall. The luminaire features an integrated 4W LED with built-in dimmable LED driver and efficient shielding for glare-free light.

Treated with a 7-step powderpaint for outdoor use, lolite can be used both indoors and outdoors. Recommended mounting height: 25-50 cm from floor/ground. Cable/tube inputs on the luminaire's rear side. Material: Die-cast aluminium. Class I – IP55.

- TECHNICAL DATA** **Mounting:** surface mounting
- Body:** aluminium
- Colour:** black, white
- ELECTRICAL DATA** **Includes light source:** YES
- Power:** 230V 50-60Hz
- Type of equipment:** triac dimming
- OPTICAL DATA** **Light distribution:** symmetric
- Way of lighting:** direct
- GENERAL DATA** **Lifetime (L70B10):** 50 000 h
- SDCM:** 4
- Warranty:** 5 years



Round



Square



| Electrical number | Code    | (IP) | (W) | (Lm) | (lm/W) | (K)  | CRI | Colour | Diameter/depth (mm) |
|-------------------|---------|------|-----|------|--------|------|-----|--------|---------------------|
| <b>Round</b>      |         |      |     |      |        |      |     |        |                     |
| 45 155 25         | 3109795 | 55   | 4   | 305  | 76     | 2700 | 80  | Black  | 105/35              |
| 45 155 26         | 3109796 | 55   | 4   | 305  | 76     | 2700 | 80  | White  | 105/35              |

| Electrical number | Code    | (IP) | (W) | (Lm) | (lm/W) | (K)  | CRI | Colour | Width/height/depth (mm) |
|-------------------|---------|------|-----|------|--------|------|-----|--------|-------------------------|
| <b>Square</b>     |         |      |     |      |        |      |     |        |                         |
| 45 155 23         | 3109793 | 55   | 4   | 305  | 76     | 2700 | 80  | Black  | 105/105/35              |
| 45 155 24         | 3109794 | 55   | 4   | 305  | 76     | 2700 | 80  | White  | 105/105/35              |

**OTHER PICTURES**

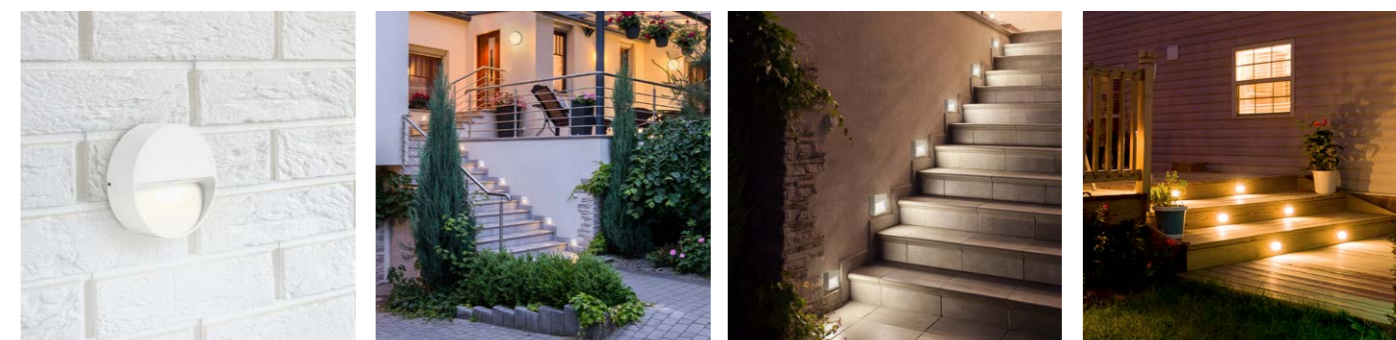

**DIMENSIONAL DRAWING**

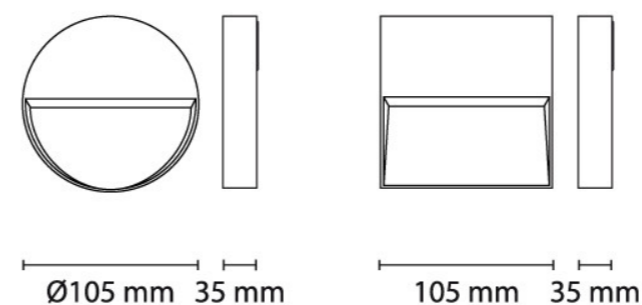



PLUTO SLIM with its glare free downward light distribution is a perfect fitting for pathway or stair case illumination. Wall recessed fixtures PLUTO is available with LED light source in 3000K or 4000K. A shallow recessbox are included with the luminaire.



**TECHNICAL DATA** **Mounting:** wall recessed  
**Body:** aluminium  
**Colour:** graphite

**ELECTRICAL DATA** **Includes light source:** YES  
**Power:** 230V 50-60Hz  
**Type of equipment:** ON/OFF

**OPTICAL DATA** **Light distribution:** symmetric  
**Way of lighting:** direct

**GENERAL DATA** **Lifetime (L70B10):** 50 000 h  
**SDCM:** 5  
**Warranty:** 5 years



Graphite



Silver

| Electrical number      | Code            | Colour   | (IP) | (IK) | (W) | (Lm) | (lm/W) | (K)  | CRI | Width/height/depth (mm) |
|------------------------|-----------------|----------|------|------|-----|------|--------|------|-----|-------------------------|
| <b>PLUTO SLIM ramp</b> |                 |          |      |      |     |      |        |      |     |                         |
| 45 154 99              | 6015-0-3-830-02 | Graphite | 65   | 9    | 12  | 554  | 46     | 4000 | 80  | 250/275/105             |
|                        | 3109476         | Graphite | 65   | 9    | 12  | 552  | 46     | 3000 | 80  | 250/275/105             |
|                        | 3109477         | Silver   | 65   | 9    | 12  | 552  | 46     | 3000 | 80  | 250/275/105             |

**Also available in following colours**

- Black (RAL 9005)
- Graphite (RAL 7016)
- Dark Grey (RAL 7037)
- Aluminium Silver (RAL 9006)
- White (RAL 9010)

**OTHER PICTURES**

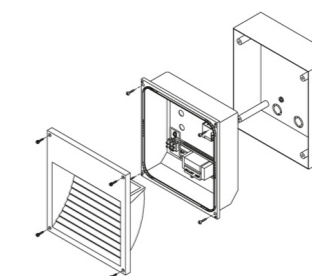
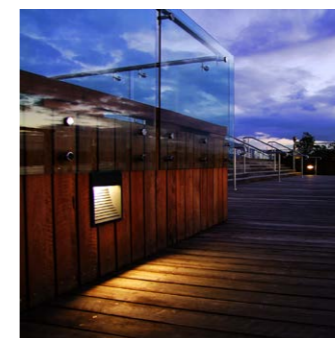
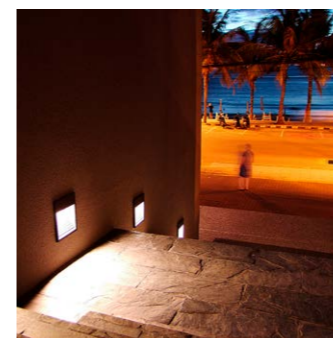

**DIMENSIONAL DRAWING**

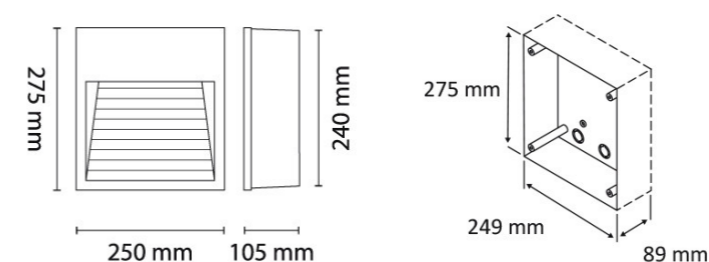

**LIGHT BEAM CURVES**

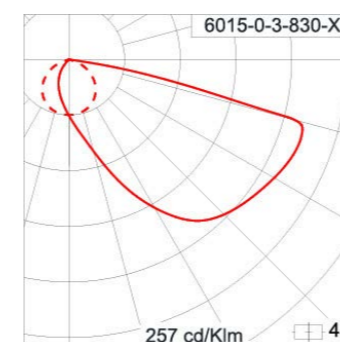



I-Brick is a solid recessed die-cast aluminium orientation luminaire. Specially treated for outdoor use. Integrated LED and built-in LED driver. Not dimmable. Comes with a recess box.

Some combinations of colors and light colors are produced to order. Material: Die-cast aluminium. Class I – IP54.



**TECHNICAL DATA** Mounting: wall recessed  
Body: high pressure die-cast aluminium  
Colour: graphite

**ELECTRICAL DATA** Includes light source: YES  
Power: 230V 50-60Hz  
Type of equipment: ON/OFF

**OPTICAL DATA** Light distribution: asymmetric  
Way of lighting: direct

**GENERAL DATA** Lifetime (L70B10): 50 000 h  
SDCM: 3  
Warranty: 5 years



| Electrical number     | Code            | Colour   | (IP) | (IK) | (W) | (Lm) | (lm/W) | (K)  | CRI | Width/height/depth (mm) |
|-----------------------|-----------------|----------|------|------|-----|------|--------|------|-----|-------------------------|
| <b>I-Brick 1</b>      |                 |          |      |      |     |      |        |      |     |                         |
| 45 154 58             | 3109470         | Graphite | 54   | 8    | 4,1 | 41   | 10     | 3000 | 80  | 248/82/114              |
| 45 154 96             | 6000-0-3-938-02 | Graphite | 54   | 8    | 4,1 | 50   | 13     | 4000 | 80  | 248/82/114              |
| <b>I-Brick-H-Ramp</b> |                 |          |      |      |     |      |        |      |     |                         |
| 45 154 59             | 3109472         | Graphite | 54   | 8    | 4,1 | 75   | 19     | 3000 | 80  | 248/82/119              |
| 45 154 98             | 6060-0-3-938-02 | Graphite | 54   | 8    | 4,1 | 80   | 21     | 4000 | 80  | 248/82/119              |

**Also available in following colours**

- Black (RAL 9005)
- Graphite (RAL 7016)
- Dark Grey (RAL 7037)
- Aluminium Silver (RAL 9006)
- White (RAL 9010)

**OTHER PICTURES**

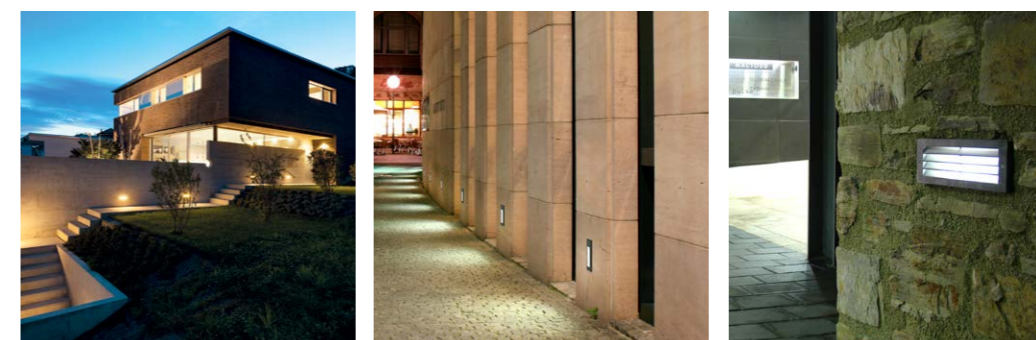

**DIMENSIONAL DRAWING**

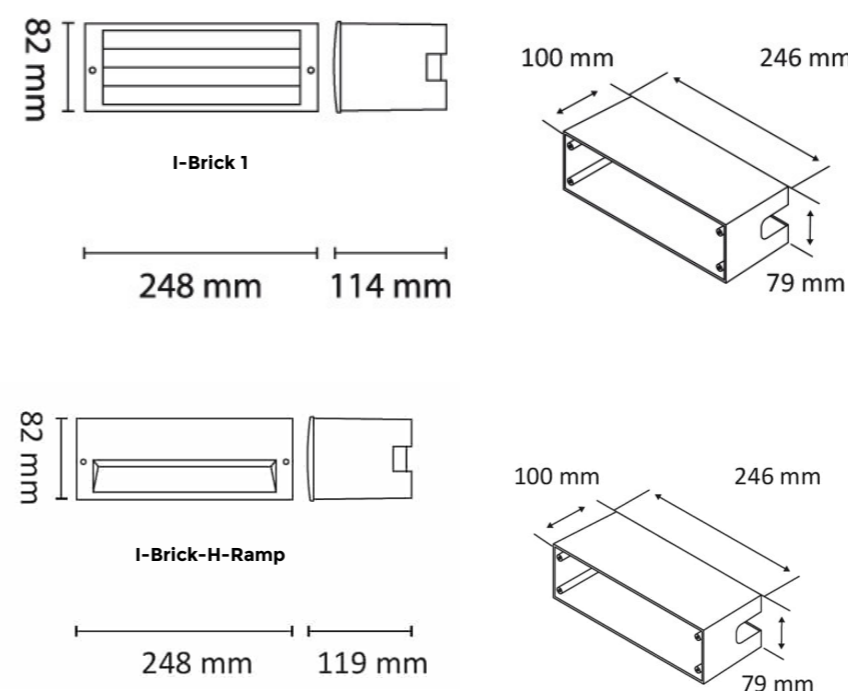

**LIGHT BEAM CURVES**

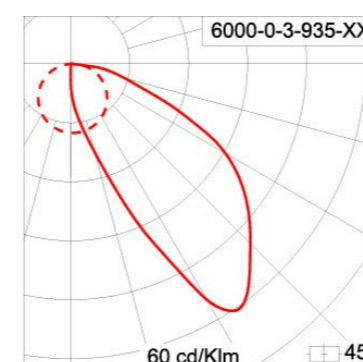

QuickStep is a small recessed orientation luminaire for lighting walking surfaces, stairs and passages indoors as well as outdoors. The luminaire comes with an integrated dimmable LED driver that can be dimmed to a very low level.

Front plate in lacquered aluminium or brushed stainless steel. Asymmetrical down light distribution. QuickStep are supplied with an optional recess/cast box and the luminaire is available in both 2700K and 3000K. Connection: 50cm rubber cable with open end.

- TECHNICAL DATA** Mounting: wall recessed
- Body: aluminium
- Colour: black, white, steel
- ELECTRICAL DATA** Includes light source: YES
- Power: 230V 50-60Hz
- Type of equipment: triac dimming
- OPTICAL DATA** Light distribution: asymmetric
- Way of lighting: direct
- GENERAL DATA** Lifetime (L70B10): 50 000 h
- SDCM: 4
- Warranty: 5 years

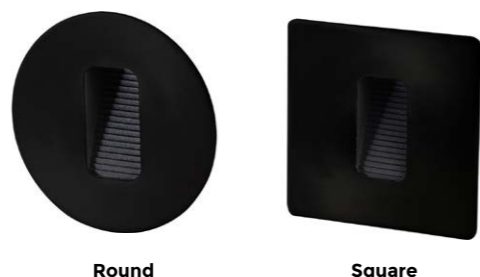

Round

Square



| Electrical number | Code    | (IP) | (W) | (Lm) | (lm/W) | (K)  | CRI | Colour | Diameter / Width (mm) |
|-------------------|---------|------|-----|------|--------|------|-----|--------|-----------------------|
| <b>Round</b>      |         |      |     |      |        |      |     |        |                       |
| 45 175 19         | 3235760 | 55   | 3   | 250  | 83     | 2700 | 80  | Black  | 95/82                 |
| 45 175 20         | 3235761 | 55   | 3   | 250  | 83     | 2700 | 80  | Steel  | 95/82                 |
| 45 175 21         | 3235762 | 55   | 3   | 250  | 83     | 2700 | 80  | White  | 95/82                 |
| 45 175 22         | 3235763 | 55   | 3   | 250  | 83     | 3000 | 80  | Black  | 95/82                 |
| 45 175 23         | 3235764 | 55   | 3   | 250  | 83     | 3000 | 80  | Steel  | 95/82                 |
| 45 175 24         | 3235765 | 55   | 3   | 250  | 83     | 3000 | 80  | White  | 95/82                 |

| Electrical number | Code    | (IP) | (W) | (Lm) | (lm/W) | (K)  | CRI | Colour | Width / Height / Depth (mm) |
|-------------------|---------|------|-----|------|--------|------|-----|--------|-----------------------------|
| <b>Square</b>     |         |      |     |      |        |      |     |        |                             |
| 45 175 25         | 3235766 | 55   | 3   | 250  | 83     | 2700 | 80  | Black  | 95/95/82                    |
| 45 175 27         | 3235768 | 55   | 3   | 250  | 83     | 2700 | 80  | White  | 95/95/82                    |
| 45 175 26         | 3235767 | 55   | 3   | 250  | 83     | 2700 | 80  | Steel  | 95/95/82                    |
| 45 175 28         | 3235769 | 55   | 3   | 250  | 83     | 3000 | 80  | Black  | 95/95/82                    |
| 45 175 29         | 3235770 | 55   | 3   | 250  | 83     | 3000 | 80  | Steel  | 95/95/82                    |
| 45 175 30         | 3235771 | 55   | 3   | 250  | 83     | 3000 | 80  | White  | 95/95/82                    |

OTHER PICTURES



DIMENSIONAL DRAWING

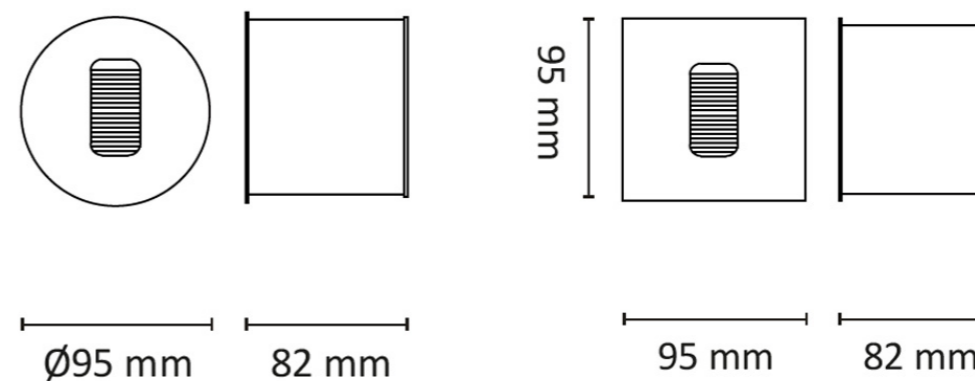

Golf is a stylish and decorative dimmable wall lamp with up/down light. The aluminium luminaire housing is machined out of a piece of solid aluminium - no loose parts. Clear tempered glass covers the aluminium reflectors. Cable entry at the back. Dimmable. Black and white model are powder coated and may be used outdoors. 2x3W. 2700K.



**TECHNICAL DATA** Mounting: wall  
Body: aluminium  
Colour: black, copper, white

**ELECTRICAL DATA** Includes light source: YES  
Power: 230V 50-60Hz  
Type of equipment: triac dimming

**OPTICAL DATA** Light distribution: symmetric  
Way of lighting: direct/indirect

**GENERAL DATA** Lifetime (L70B10): 50 000 h  
SDCM: 3  
Warranty: 5 years



Black



White

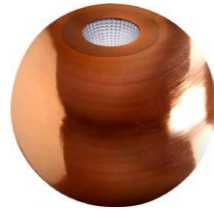

Copper

| Electrical number | Code    | (IP) | (W) | (Lm)  | (lm/W) | (K)  | Colour | Width/height/Depth (mm) |
|-------------------|---------|------|-----|-------|--------|------|--------|-------------------------|
| <b>Golf</b>       |         |      |     |       |        |      |        |                         |
| 45 155 32         | 3109775 | 55   | 2x3 | 2x260 | 85,5   | 2700 | Black  | 100/84/92               |
| 45 155 33         | 3109776 | 55   | 2x3 | 2x260 | 85,5   | 2700 | White  | 100/84/92               |
| 45 155 34         | 3109777 | 55   | 2x3 | 2x260 | 85,5   | 2700 | Copper | 100/84/92               |

OTHER PICTURES

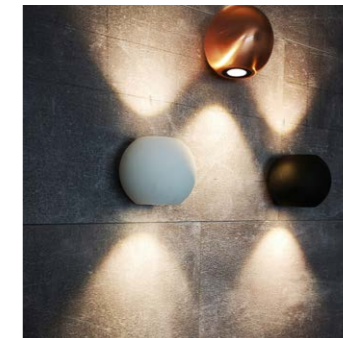

DIMENSIONAL DRAWING

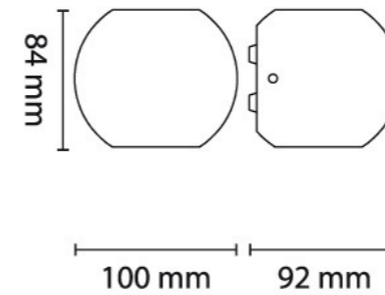

Drift family is a square, low-build vandal-proof cast aluminium ceiling and wall fixture. Modern designs, great finish and a surface treatment that lasts. Unilamp's special surface treatment for aggressive environments, that is, a 16-step process topped with special varnish. This makes the Drift series ideal for use in coastal areas. The LED`s are spread over a wide area on the hinged and tool-less replaceable component plate. The connection between this plate and the luminaire base are via an IP20 quick connector for easy mounting and servicefriendly maintenance. A very uniform light distribution and the low profile makes this luminaire an elegant choice.







- TECHNICAL DATA** Mounting: wall, ceiling  
Body: aluminium  
Colour: graphite  
Diffuser: opal / polycarbonate
- ELECTRICAL DATA** Includes light source: YES  
Power: 230V 50-60Hz  
Type of equipment: ON/OFF
- OPTICAL DATA** Light distribution: symmetric  
Way of lighting: direct
- GENERAL DATA** Lifetime (L70B50): 50 000 h  
SDCM: 4  
Warranty: 5 years



| Electrical number   | Code            | (IP) | (W) | (Lm) | (lm/W) | (K)  | (IK) | CRI/Ra | Diameter/height (mm) |
|---------------------|-----------------|------|-----|------|--------|------|------|--------|----------------------|
| <b>Drift Cross</b>  |                 |      |     |      |        |      |      |        |                      |
| 45 174 14           | 7033-0-3-803-02 | 65   | 12  | 750  | 63     | 3000 | 9    | 80     | 270/270/79           |
| 45 174 18           | 7033-0-3-807-02 | 65   | 12  | 750  | 63     | 4000 | 9    | 80     | 270/270/79           |
| <b>Drift Eyelid</b> |                 |      |     |      |        |      |      |        |                      |
| 45 174 15           | 3109596         | 65   | 12  | 375  | 32     | 3000 | 9    | 80     | 270/270/74           |
| 45 174 19           | 7035-0-3-807-02 | 65   | 12  | 375  | 32     | 4000 | 9    | 80     | 270/270/74           |
| <b>Drift Flat</b>   |                 |      |     |      |        |      |      |        |                      |
| 45 154 57           | 3109441         | 65   | 12  | 750  | 63     | 3000 | 9    | 80     | 270/270/74           |
| 45 174 17           | 7024-0-3-807-02 | 65   | 14  | 750  | 63     | 4000 | 9    | 80     | 270/270/74           |
| <b>Drift Roof</b>   |                 |      |     |      |        |      |      |        |                      |
| 45 174 16           | 7039-0-3-803-02 | 65   | 14  | 750  | 63     | 3000 | 9    | 80     | 270/270/135          |
| 45 174 20           | 7039-0-3-807-02 | 65   | 14  | 750  | 63     | 4000 | 9    | 80     | 270/270/135          |

**Also available in following colours**

-  Black (RAL 9005)
-  Graphite (RAL 7016)
-  Dark Grey (RAL 7037)
-  Aluminium Silver (RAL 9006)
-  White (RAL 9010)

**OTHER PICTURES**



**DIMENSIONAL DRAWING**

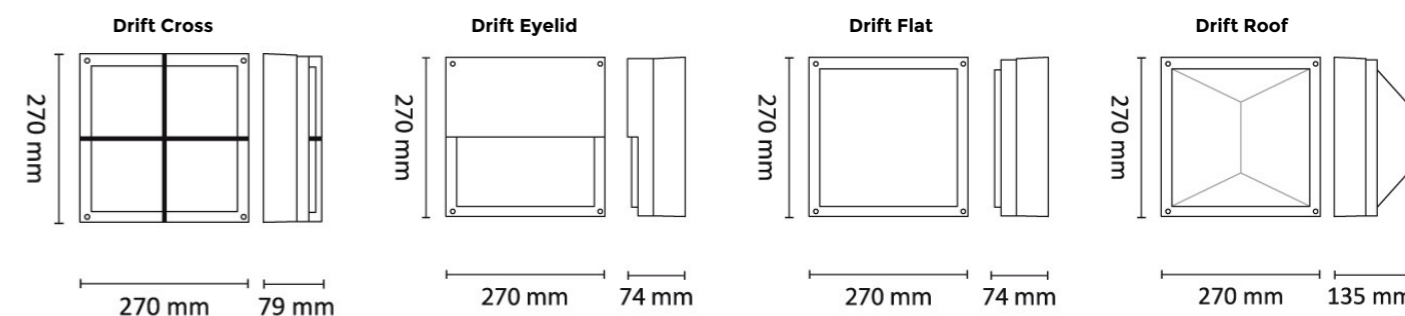

**LIGHT BEAM CURVES**

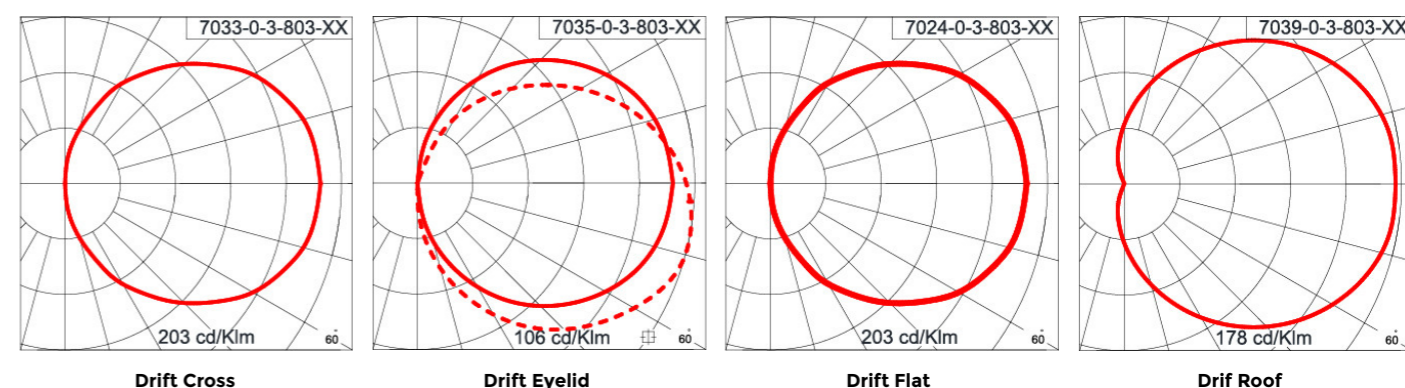

IP65 rated, LED, colour selectable circular bulkhead

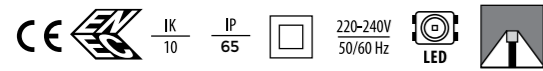

**CONSTRUCTION** **Mounting:** for surface mounting  
**Body & bezel:** 2 versions – plain round & round with eyelid cover.  
 Both made of polycarbonate, black RAL9006  
**Optic:** opal polycarbonate diffuser

**TECHNICAL DATA** **Driver:** integral, included  
**Dimming:** not dimmable  
**Power factor:** >0.95  
**Electrical connection:** terminal block, 3 x 2 x 2.5mm<sup>2</sup>

**GENERAL DATA** **Application:** building entrances and perimeters  
**Operating temperature:** -20°C - +25°C  
**Lumen depreciation:** L70: B50: 100,000 hours  
**SDCM:** <3  
**Warranty:** 5 years



| Electrical number | Code                     | W  | lm   | lm/W | K               | CRI/Ra | Frame    |
|-------------------|--------------------------|----|------|------|-----------------|--------|----------|
| <b>Huntsville</b> |                          |    |      |      |                 |        |          |
| 45 440 12         | BB/NHU12/830-840-857     | 12 | 1344 | 114  | 3000/4000/5700K | ≥80    | Circular |
| 45 440 13         | BB/NHU12/EYL/830-840-857 | 12 | 1240 | 104  | 3000/4000/5700K | ≥80    | Eyelid   |

OTHER PICTURES



HUNTSVILLE circular



HUNTSVILLE eyelid

DIMENSIONAL DRAWING

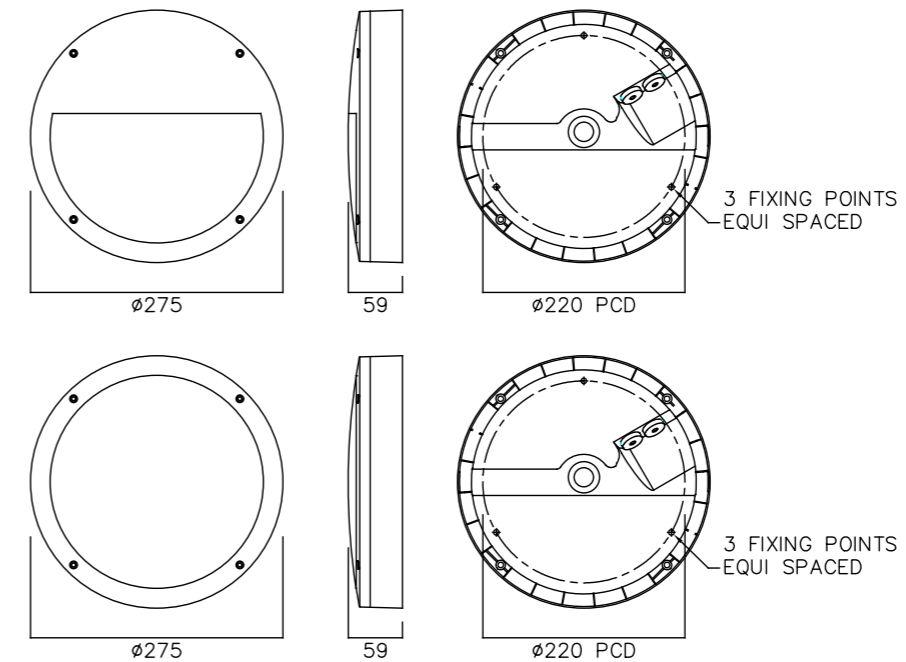

LIGHT BEAM CURVES

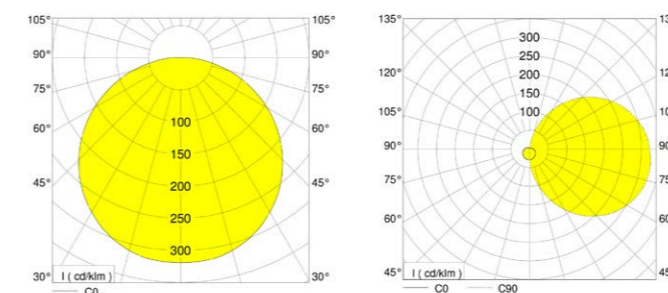

HUNTSVILLE circular

HUNTSVILLE circular



**RETINA-MAXI**  
(page 232)



Retina is a vandal-proof die-cast aluminium ceiling and wall lamp with a modern design, a great finish and a surface treatment that lasts for ages. Surface treated with Unilamp's special treatment for aggressive environments, a 16-step process topped with special varnish. This makes the Retina series ideal for use in coastal areas. Toolless replaceable component/LED light plate with or without sensor. When using sensor variant or standard luminaire as slave luminaire, base lights can be set to 0, 25 or 50% of max set light. Warm white color temperature, 3000K. Retina comes in two sizes, standard size and Maxi which is a large-format wall fixture. Light performance is 850 lumens out of luminaire. Retina Maxi has adjustable top level of 2000 lumens (replaces 2x26W), 1500 lumens (replaces 2x18W) or 1000 lumens (replaces 1x26W). Retina is available in white, silver and graphite.



**TECHNICAL DATA** **Mounting:** surface mounting  
**Body:** high pressure die-cast aluminium  
**Colour:** graphite, Silver, White  
**Diffuser:** opal

**ELECTRICAL DATA** **Includes light source:** YES  
**Power:** 230V 50-60Hz  
**Type of equipment:** (Non dimmable) ON/OFF/SENSOR

**OPTICAL DATA** **Light distribution:** symmetric  
**Way of lighting:** direct

**GENERAL DATA** **Lifetime (L70B10):** 50 000 h  
**SDCM:** 5  
**Warranty:** 5 years



| Electrical number | Code            | (IP) | (IK) | (W) | (Lm) | (lm/W) | (K)  | CRI | Colour   | Diameter/depth (mm) |
|-------------------|-----------------|------|------|-----|------|--------|------|-----|----------|---------------------|
| <b>Retina</b>     |                 |      |      |     |      |        |      |     |          |                     |
| 45 154 17         | 3109400         | 65   | 9    | 12  | 847  | 71     | 3000 | 80  | Silver   | 265/100             |
| 45 154 18         | 3109401         | 65   | 9    | 12  | 847  | 71     | 3000 | 80  | Graphite | 265/100             |
| 45 154 19         | 3109402         | 65   | 9    | 12  | 847  | 71     | 3000 | 80  | White    | 265/100             |
| 45 174 80         | 7009-0-3-805-04 | 65   | 9    | 14  | 720  | 51     | 4000 | 80  | Silver   | 265/100             |
| 45 174 81         | 7009-0-3-805-02 | 65   | 9    | 14  | 720  | 51     | 4000 | 80  | Graphite | 265/100             |
| 45 174 82         | 7009-0-3-805-06 | 65   | 9    | 14  | 720  | 51     | 4000 | 80  | White    | 265/100             |
| <b>Retina PIR</b> |                 |      |      |     |      |        |      |     |          |                     |
| 45 154 20         | 3109405         | 65   | 9    | 12  | 847  | 71     | 3000 | 80  | Silver   | 265/100             |
| 45 154 21         | 3109406         | 65   | 9    | 12  | 847  | 71     | 3000 | 80  | Graphite | 265/100             |
| 45 154 22         | 3109407         | 65   | 9    | 12  | 847  | 71     | 3000 | 80  | White    | 265/100             |

**Also available in following colours**

- Black (RAL 9005)
- Graphite (RAL 7016)
- Dark Grey (RAL 7037)
- Aluminium Silver (RAL 9006)
- White (RAL 9010)

**OTHER PICTURES**



**DIMENSIONAL DRAWING**

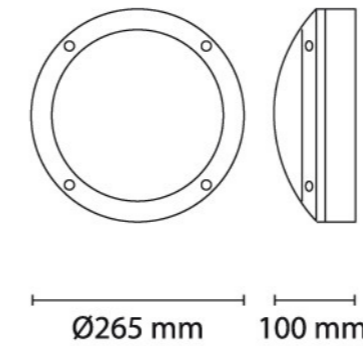

**LIGHT BEAM CURVES**

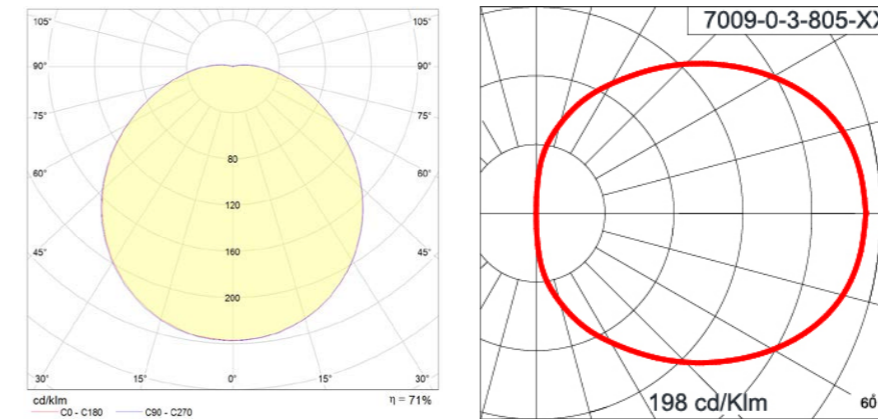

The Retina family are vandal-proof die-cast aluminium ceiling and wall lamps with modern design, great finish and surface treatment that lasts for ages. The finishing are with Unilamp's special treatment for aggressive environments, a 16-step process topped with special varnish. This makes the Retina series ideal for use in coastal areas. Toolless replaceable component/LED light plate with or without sensor. Retina is available in white, silver and graphite.

- TECHNICAL DATA**  
**Mounting:** surface mounting  
**Body:** high pressure die-cast aluminium  
**Colour:** graphite, Silver, White  
**Diffuser:** opal
- ELECTRICAL DATA**  
**Includes light source:** YES  
**Power:** 230V 50-60Hz  
**Type of equipment:** (Non dimmable) ON/OFF
- OPTICAL DATA**  
**Light distribution:** symmetric  
**Way of lighting:** direct
- GENERAL DATA**  
**Lifetime (L70B10):** 50 000 h  
**SDCM:** 5  
**Warranty:** 5 years



| Electrical number   | Code            | (IP) | (W) | (Lm) | (lm/W) | (K)  | CRI | Colour   | Diameter/depth (mm) |
|---------------------|-----------------|------|-----|------|--------|------|-----|----------|---------------------|
| <b>Retina Cross</b> |                 |      |     |      |        |      |     |          |                     |
| 45 154 23           | 3109410         | 65   | 12  | 472  | 40     | 3000 | 80  | Silver   | 265/120             |
| 45 154 24           | 3109411         | 65   | 12  | 472  | 40     | 3000 | 80  | Graphite | 265/120             |
| 45 154 25           | 3109412         | 65   | 12  | 472  | 40     | 3000 | 80  | White    | 265/120             |
| 45 174 83           | 7037-0-3-805-04 | 65   | 14  | 472  | 40     | 4000 | 80  | Silver   | 265/120             |
| 45 174 84           | 7037-0-3-805-02 | 65   | 14  | 472  | 40     | 4000 | 80  | Graphite | 265/120             |
| 45 174 85           | 7037-0-3-805-06 | 65   | 14  | 472  | 40     | 4000 | 80  | White    | 265/120             |

**Also available in following colours**

- Black (RAL 9005)
- Graphite (RAL 7016)
- Dark Grey (RAL 7037)
- Aluminium Silver (RAL 9006)
- White (RAL 9010)

**OTHER PICTURES**



**DIMENSIONAL DRAWING**

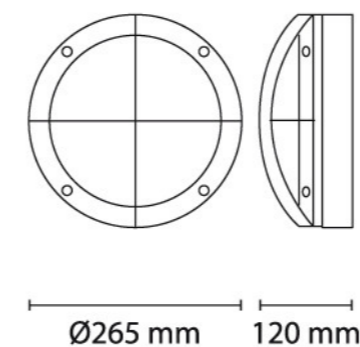

**LIGHT BEAM CURVES**

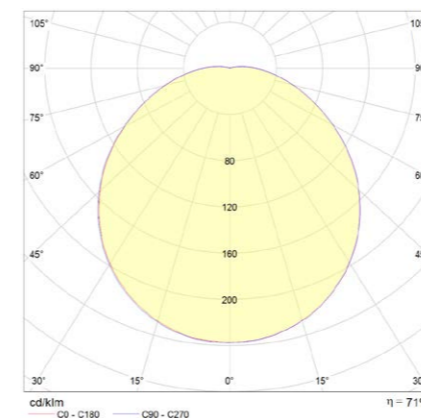

The Retina family are vandal-proof die-cast aluminium ceiling and wall lamps with modern design, great finish and surface treatment that lasts for ages. The finishing are with Unilamp's special treatment for aggressive environments, a 16-step process topped with special varnish. This makes the Retina series ideal for use in coastal areas. Toolless replaceable component/LED light plate with or without sensor. Retina is available in white, silver and graphite.



**TECHNICAL DATA** Mounting: surface mounting  
Body: high pressure die-cast aluminium  
Colour: graphite, Silver, White

**ELECTRICAL DATA** Includes light source: YES  
Power: 230V 50-60Hz  
Type of equipment: ON/OFF





**OPTICAL DATA** Light distribution: symmetric  
Way of lighting: direct

**GENERAL DATA** Lifetime (L70B10): 50 000 h  
SDCM: 5  
Warranty: 5 years



| Electrical number    | Code            | (IP) | (W) | (Lm) | (lm/W) | (K)  | CRI | Colour   | Diameter/depth (mm) |
|----------------------|-----------------|------|-----|------|--------|------|-----|----------|---------------------|
| <b>Retina Eyelid</b> |                 |      |     |      |        |      |     |          |                     |
| 45 154 26            | 3109430         | 65   | 12  | 472  | 40     | 3000 | 80  | Graphite | 265/105             |
| 45 154 27            | 3109431         | 65   | 12  | 472  | 40     | 3000 | 80  | Silver   | 265/105             |
| 45 154 28            | 3109432         | 65   | 12  | 472  | 40     | 3000 | 80  | White    | 265/105             |
| 45 174 86            | 7015-0-3-805-02 | 65   | 14  | 472  | 40     | 4000 | 80  | Graphite | 265/105             |
| 45 174 87            | 7015-0-3-805-04 | 65   | 14  | 472  | 40     | 4000 | 80  | Silver   | 265/105             |
| 45 174 88            | 7015-0-3-805-06 | 65   | 14  | 472  | 40     | 4000 | 80  | White    | 265/105             |

**Also available in following colours**

-  Black (RAL 9005)
-  Graphite (RAL 7016)
-  Dark Grey (RAL 7037)
-  Aluminium Silver (RAL 9006)
-  White (RAL 9010)

**OTHER PICTURES**



**DIMENSIONAL DRAWING**

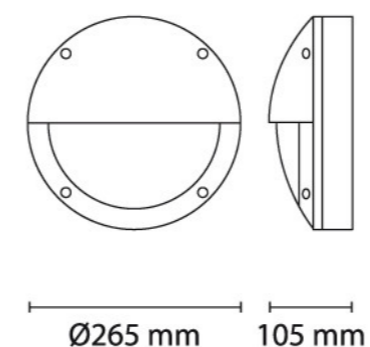

**LIGHT BEAM CURVES**

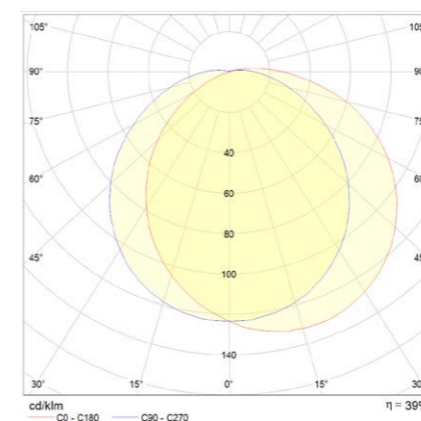

The Retina family are vandal-proof die-cast aluminium ceiling and wall lamps with modern design, great finish and surface treatment that lasts for ages. The finishing are with Unilamp's special treatment for aggressive environments, a 16-step process topped with special varnish. This makes the Retina series ideal for use in coastal areas. Toolless replaceable component/LED light plate with or without sensor. Retina is available in white, silver and graphite. Retina Flat is a more shallow design, with its flat cover.



**TECHNICAL DATA** Mounting: surface mounting  
Body: high pressure die-cast aluminium  
Colour: graphite, Silver, White  
Diffuser: opal

**ELECTRICAL DATA** Includes light source: YES  
Power: 230V 50-60Hz  
Type of equipment: triac dimming

**OPTICAL DATA** Light distribution: symmetric  
Way of lighting: direct

**GENERAL DATA** Lifetime (L70B10): 50 000 h  
SDCM: 5  
Warranty: 5 years



| Electrical number  | Code            | (IP) | (W) | (Lm) | (lm/W) | (K)  | CRI | Colour   | Diameter/depth (mm) |
|--------------------|-----------------|------|-----|------|--------|------|-----|----------|---------------------|
| <b>Retina Flat</b> |                 |      |     |      |        |      |     |          |                     |
| 45 174 01          | 7072-0-3-805-02 | 65   | 14  | 950  | 67     | 4000 | 80  | Graphite | 265/72              |
| 45 174 71          | 7072-0-3-805-04 | 65   | 14  | 950  | 67     | 4000 | 80  | Silver   | 265/72              |
| 45 174 72          | 7072-0-3-805-06 | 65   | 14  | 950  | 67     | 4000 | 80  | White    | 265/72              |
| 45 174 74          | 7072-0-3-801-04 | 65   | 14  | 950  | 67     | 3000 | 80  | Silver   | 265/72              |
| 45 174 75          | 7072-0-3-801-06 | 65   | 14  | 950  | 67     | 3000 | 80  | White    | 265/72              |
| 45 174 78          | 7072-0-3-801-02 | 65   | 14  | 950  | 67     | 3000 | 80  | Graphite | 265/72              |

**Also available in following colours**

- Black (RAL 9005)
- Graphite (RAL 7016)
- Dark Grey (RAL 7037)
- Aluminium Silver (RAL 9006)
- White (RAL 9010)

**OTHER PICTURES**



**DIMENSIONAL DRAWING**

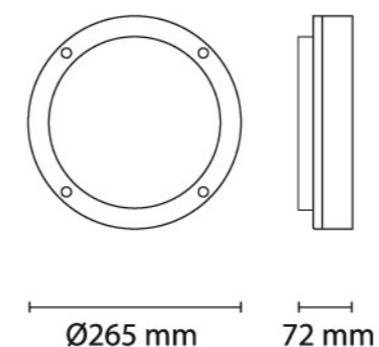

**LIGHT BEAM CURVES**

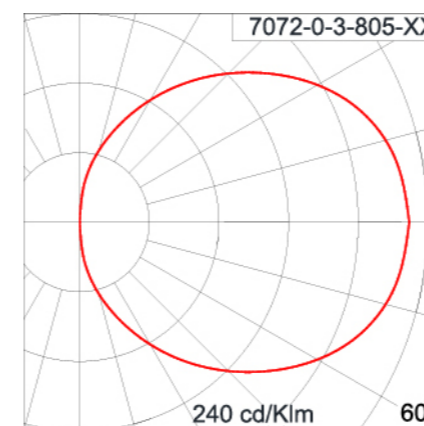

Retina is a vandal-proof die-cast aluminium ceiling and wall lamp with a modern design, a great finish and a surface treatment that lasts for ages. Surface treated with Unilamp's special treatment for aggressive environments, a 16-step process topped with special varnish. This makes the Retina series ideal for use in coastal areas. Toolless replaceable component/LED light plate with or without sensor. When using sensor variant or standard luminaire as slave luminaire, base lights can be set to 0, 25 or 50% of max set light. Retina is available in white, silver and graphite.



**TECHNICAL DATA**  
Mounting: surface mounting  
Body: high pressure die-cast aluminium  
Colour: graphite, silver, white  
Diffuser: opal

**ELECTRICAL DATA**  
Includes light source: YES  
Power: 230V 50-60Hz  
Type of equipment: triac dimming

**OPTICAL DATA**  
Light distribution: symmetric  
Way of lighting: direct

**GENERAL DATA**  
Lifetime (L70B10): 50 000 h  
SDCM: 5  
Warranty: 5 years



| Electrical number      | Code            | (IP) | (W) | (Lm) | (lm/W) | (K)  | CRI | Colour   | Diameter/depth (mm) |
|------------------------|-----------------|------|-----|------|--------|------|-----|----------|---------------------|
| <b>Retina Maxi</b>     |                 |      |     |      |        |      |     |          |                     |
| 45 154 60              | 3109650         | 65   | 23  | 2000 | 87     | 3000 | 80  | Graphite | 360/145             |
| 45 174 90              | 3109651         | 65   | 23  | 2000 | 87     | 3000 | 80  | Silver   | 360/145             |
| 45 174 91              | 3109652         | 65   | 23  | 2000 | 87     | 3000 | 80  | White    | 360/145             |
| 45 174 02              | 7010-0-3-824-02 | 65   | 27  | 2000 | 87     | 4000 | 80  | Graphite | 360/145             |
| 45 174 03              | 7010-0-3-824-04 | 65   | 27  | 2000 | 87     | 4000 | 80  | Silver   | 360/145             |
| 45 174 04              | 7010-0-3-824-06 | 65   | 27  | 2000 | 87     | 4000 | 80  | White    | 360/145             |
| 45 174 79              | 7017-0-3-823-04 | 65   | 27  | 2000 | 87     | 3000 | 80  | Silver   | 360/145             |
| 45 174 92              | 7017-0-3-823-02 | 65   | 27  | 2000 | 87     | 3000 | 80  | Graphite | 360/145             |
| <b>Retina Maxi PIR</b> |                 |      |     |      |        |      |     |          |                     |
|                        | 3109653         | 65   | 23  | 2000 | 87     | 3000 | 80  | Graphite | 360/145             |
|                        | 3109654         | 65   | 23  | 2000 | 87     | 3000 | 80  | Silver   | 360/145             |
|                        | 3109655         | 65   | 23  | 2000 | 87     | 3000 | 80  | White    | 360/145             |
| <b>Retina Maxi S</b>   |                 |      |     |      |        |      |     |          |                     |
| 45 174 45              | 7017-0-3-824-02 | 65   | 27  | 2000 | 87     | 4000 | 80  | Graphite | 360/175             |
| 45 174 46              | 7017-0-3-824-04 | 65   | 27  | 2000 | 87     | 4000 | 80  | Silver   | 360/175             |
| 45 174 47              | 7017-0-3-824-06 | 65   | 27  | 2000 | 87     | 4000 | 80  | White    | 360/175             |
| 45 154 90              | 7017-0-3-823-06 | 65   | 27  | 2000 | 87     | 3000 | 80  | White    | 360/175             |

Also available in following colours

- Black (RAL 9005)
- Graphite (RAL 7016)
- Dark Grey (RAL 7037)
- Aluminium Silver (RAL 9006)
- White (RAL 9010)

OTHER PICTURES



DIMENSIONAL DRAWING

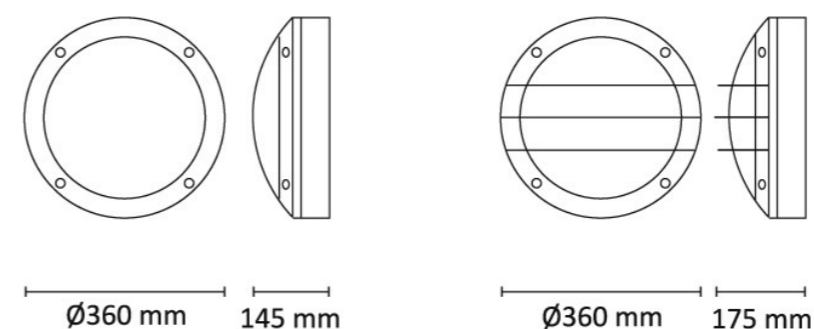

LIGHT BEAM CURVES

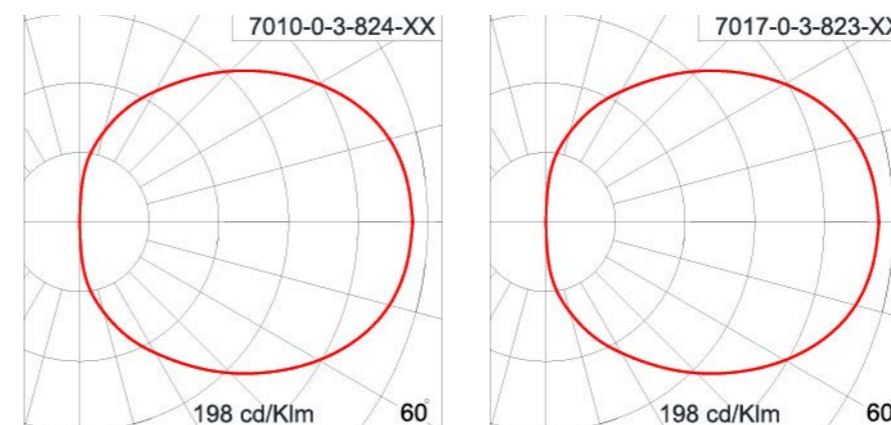

Sylo is a functional, compact and stylish ceiling lamp for use outdoors and indoor. Opal shielding covers the integrated LED plate for very even light distribution. Modern design language with straight, clean lines. The luminaire has two cable glands at the back. For use with an external cable, the optional descent ring can be used.

The 10W version is dimmable and comes with an integrated dimmable LED driver. 20W versions are not dimmable.



- TECHNICAL DATA** **Mounting:** ceiling, surface mounting
- Body:** aluminium
- Colour:** black, white
- Diffuser:** opal
- ELECTRICAL DATA** **Includes light source:** YES
- Power:** 230V 50-60Hz
- Type of equipment:** ON/OFF, Triac Dimmable
- OPTICAL DATA** **Light distribution:** symmetric
- Way of lighting:** direct
- GENERAL DATA** **Lifetime (L70B10):** 50 000 h
- SDCM:** 4
- Warranty:** 5 years



Black



White

**DIMENSIONAL DRAWING**

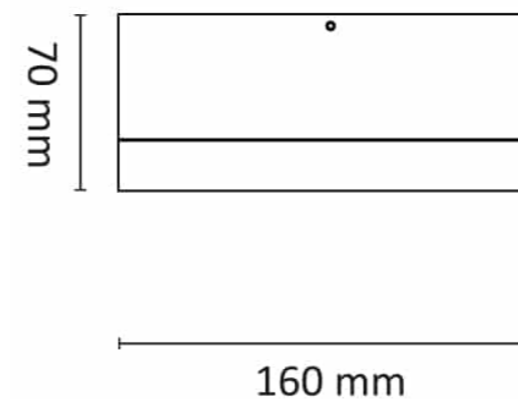

| Electrical number | Code    | (IP) | (W) | (Lm) | (lm/W) | (K)  | CRI | Colour | Diameter/height (mm) |
|-------------------|---------|------|-----|------|--------|------|-----|--------|----------------------|
| <b>Dimmable</b>   |         |      |     |      |        |      |     |        |                      |
| 45 175 11         | 3109540 | 55   | 10  | 1100 | 110    | 3000 | 80  | Black  | 160/70               |
| 45 175 12         | 3109541 | 55   | 10  | 1100 | 110    | 3000 | 80  | White  | 160/70               |
| <b>ON/OFF</b>     |         |      |     |      |        |      |     |        |                      |
| 45 175 13         | 3109542 | 55   | 20  | 1800 | 90     | 3000 | 80  | Black  | 160/70               |
| 45 175 14         | 3109543 | 55   | 20  | 1800 | 90     | 3000 | 80  | White  | 160/70               |

Polar is a further development and a design alternative to our popular Flow series. Polar comes in 20W and 36W versions with integrated dimmable LED driver. This makes it possible to dim to lower light levels at times of day where you want to save even more energy. Asymmetric light thrown forward with low glare makes Polar a good option to light up open areas and parking lots. Polar Nightlite(non-dimmable) has built-in twilight relay that lights the light when it gets dark. Polar can be attached directly to the wall or with the included distance mount for the outside cable. Corner mount, wall arm attachment or mast top is supplied as an optional extra.

Luminaire housing in solid die-cast aluminium with hardened safety glass. 7 stage surface treatment ensures good quality of luminaires for many years, even in our Nordic climate. Varieties: Asymmetric light distribution that throws the light far out from the wall/polet.

|                        |   |
|------------------------|---|
| <b>TECHNICAL DATA</b>  | <b>Mounting:</b> wall<br><b>Body:</b> aluminium<br><b>Colour:</b> black, grey   |
| <b>ELECTRICAL DATA</b> | <b>Includes light source:</b> YES<br><b>Power:</b> 230V 50-60Hz<br><b>Type of equipment:</b> triac dimming, twilight sensor |
| <b>OPTICAL DATA</b>    | <b>Light distribution:</b> asymmetric<br><b>Way of lighting:</b> direct   |
| <b>GENERAL DATA</b>    | <b>Lifetime (L70B10):</b> 50 000 h<br><b>SDCM:</b> 3<br><b>Warranty:</b> 5 years  |



Black

Grey

| Electrical number          | Code    | (IP) | (W) | (Lm) | (lm/W) | (K)  | CRI | Colour | Width/height/depth (mm) |
|----------------------------|---------|------|-----|------|--------|------|-----|--------|-------------------------|
| <b>Polar</b>               |         |      |     |      |        |      |     |        |                         |
| 45 155 36                  | 3100800 | 55   | 20  | 1560 | 78     | 3000 | 80  | Black  | 180/90/230              |
| 45 155 37                  | 3100801 | 55   | 20  | 1560 | 78     | 3000 | 80  | Grey   | 180/90/230              |
| 45 155 38                  | 3100805 | 55   | 36  | 2800 | 78     | 3000 | 80  | Black  | 180/90/230              |
| 45 155 39                  | 3100806 | 55   | 36  | 2800 | 78     | 3000 | 80  | Grey   | 180/90/230              |
| <b>Polar Nightlite PIR</b> |         |      |     |      |        |      |     |        |                         |
| 45 155 40                  | 3100810 | 55   | 20  | 1560 | 78     | 3000 | 80  | Black  | 180/90/230              |
| 45 155 41                  | 3100811 | 55   | 20  | 1560 | 78     | 3000 | 80  | Grey   | 180/90/230              |

OTHER PICTURES



DIMENSIONAL DRAWING

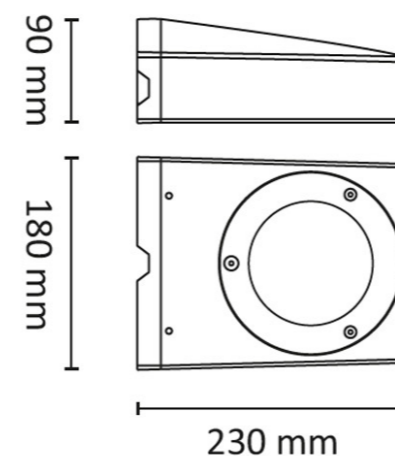

Flow is a very versatile outdoor LED luminaire with compact dimensions but still powerful brightness. The luminaire comes in dimmable 20W and 36W versions and with different optics for symmetrical, asymmetric or bi-symmetrical (Ledil lens) light distribution.

Flow can be attached directly to the wall or with the included distance mount for surface cable-installations. Corner mount, wall arm attachment or pole top can be supplied as an optional accessories. The luminaire housing is made in die-cast aluminium with tempered safety glass.

Powdercoating in a 7 stage surface treatment ensures good quality and finish of the luminaire for many years, even in the Nordic climate. Flow has integrated LED with reflector and built-in dimmable LED driver for phase dimming.

**TECHNICAL DATA** Mounting: wall  
Body: aluminium  
Colour: black, white

**ELECTRICAL DATA** Includes light source: YES  
Power: 230V 50-60Hz  
Type of equipment: triac dimming

**OPTICAL DATA** Light distribution: Symmetric, asymmetric, Bi-symmetric  
Way of lighting: direct

**GENERAL DATA** Lifetime (L70B10): 50 000 h  
SDCM: 3  
Warranty: 5 years



| Electrical number   | Code    | (W) | (Lm) | (lm/W) | (K)  | CRI | Colour | Width/height/depth (mm) |
|---------------------|---------|-----|------|--------|------|-----|--------|-------------------------|
| <b>Asymmetric</b>   |         |     |      |        |      |     |        |                         |
| 45 155 06           | 3109740 | 20  | 1560 | 78     | 3000 | 80  | Black  | 180/88/230              |
| 45 155 07           | 3109741 | 20  | 1560 | 78     | 3000 | 80  | White  | 180/88/230              |
| 45 155 08           | 3109742 | 36  | 2800 | 78     | 3000 | 80  | Black  | 180/88/230              |
| 45 155 09           | 3109743 | 36  | 2800 | 78     | 3000 | 80  | White  | 180/88/230              |
| <b>Symmetric</b>    |         |     |      |        |      |     |        |                         |
| 45 155 10           | 3109744 | 20  | 1750 | 88     | 3000 | 80  | Black  | 180/88/230              |
| 45 155 12           | 3109748 | 20  | 1650 | 83     | 3000 | 80  | Black  | 180/88/230              |
| 45 155 11           | 3109746 | 36  | 3000 | 83     | 3000 | 80  | Black  | 180/88/230              |
| 45 155 13           | 3100790 | 36  | 3100 | 86     | 3000 | 80  | Black  | 180/88/230              |
| <b>Bi-symmetric</b> |         |     |      |        |      |     |        |                         |
| 45 175 16           | 3109739 | 20  | 1560 | 78     | 3000 | 80  | Black  | 180/88/230              |

**OTHER PICTURES**



**DIMENSIONAL DRAWING**

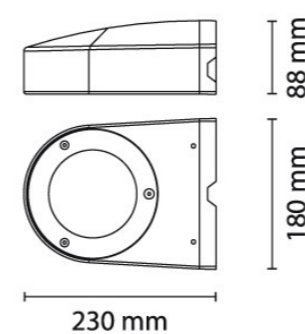

**LIGHT BEAM CURVES**

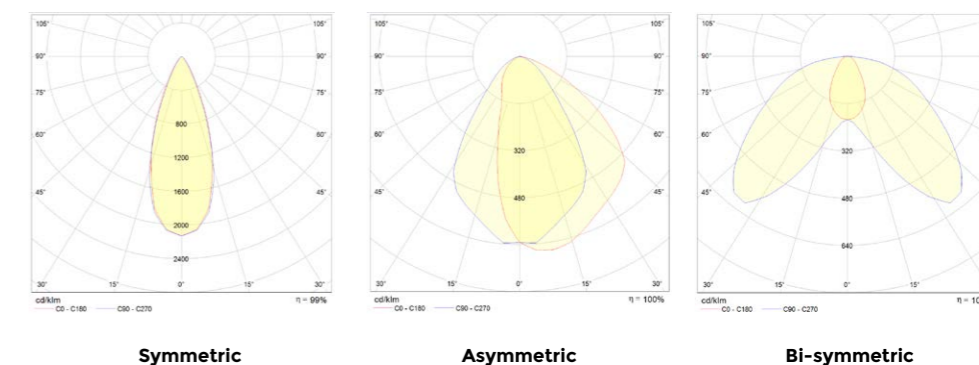

**ACCESSORIES**



e-number 45 155 14  
3109892  
Flow Corner angle accessory



e-number 45 155 15  
3109894  
Flow PT Ø60 Black accessory



e-number 45 155 16  
3109896  
Flow TA 42-48mm Black



Athlon is a compact designed, bright floodlight for wall mounting in die-cast aluminium with tempered safety glass. The luminaire comes complete with integrated LED and built-in LED driver. Athlon is suitable for lighting up facades and outdoor areas e.g. on commercial buildings.

The luminaire is available in two versions with different optics and different light distribution; Asymmetric version throws the light forward, and bi-symmetrically distributes the light wide to both sides along the mounting wall. Specially treated with Unilamp's special ASC surface treatment for outdoor use. That is, a 16 step process topped with special lacquer. The luminaire head can be tilted.

**TECHNICAL DATA**

**Mounting:** wall  
**Body:** aluminium  
**Colour:** graphite

**ELECTRICAL DATA**

**Includes light source:** YES  
**Power:** 230V 50-60Hz  
**Type of equipment:** ON/OFF

**OPTICAL DATA**

**Light distribution:** Bi-Symmetric, Asymmetric  
**Way of lighting:** direct





**GENERAL DATA**

**Lifetime (L70B50):** 50 000 h  
**SDCM:** 3  
**Warranty:** 5 years



| Electrical number | Code            | (IP) | (IK) | (W) | (Lm) | (lm/W) | (K)  | CRI/Ra | Light distribution |
|-------------------|-----------------|------|------|-----|------|--------|------|--------|--------------------|
| <b>Athlon</b>     |                 |      |      |     |      |        |      |        |                    |
| 45 154 07         | 3109820         | 65   | 7    | 26  | 1830 | 63     | 3000 | 80     | Asymmetric         |
| 45 154 08         | 3109850         | 65   | 7    | 18  | 1650 | 92     | 3000 | 80     | Bi-symmetric       |
| 45 154 85         | 2311-7-3-866-02 | 65   | 7    | 18  | 1870 | 94     | 4000 | 80     | Bi-symmetric       |
| 45 154 86         | 2310-1-3-866-02 | 65   | 7    | 18  | 1700 | 85     | 4000 | 80     | Asymmetric         |
| 45 154 87         | 2311-7-3-858-02 | 65   | 7    | 26  | 2440 | 84     | 3000 | 80     | Bi-symmetric       |
| 45 154 88         | 2310-1-3-858-02 | 65   | 7    | 26  | 2220 | 77     | 4000 | 80     | Asymmetric         |

**Also available in following colours**

-  Black (RAL 9005)
-  Graphite (RAL 7016)
-  Dark Grey (RAL 7037)
-  Aluminium Silver (RAL 9006)
-  White (RAL 9010)

**OTHER PICTURES**

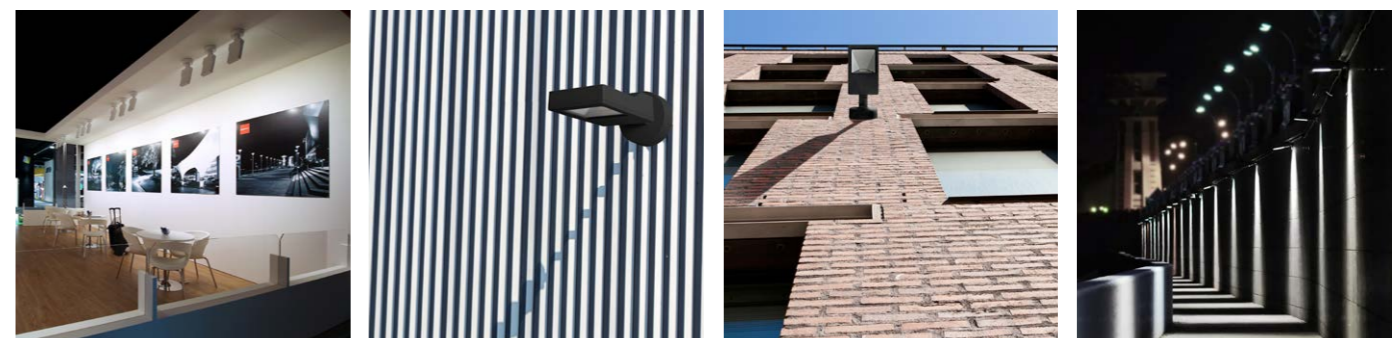

**DIMENSIONAL DRAWING**

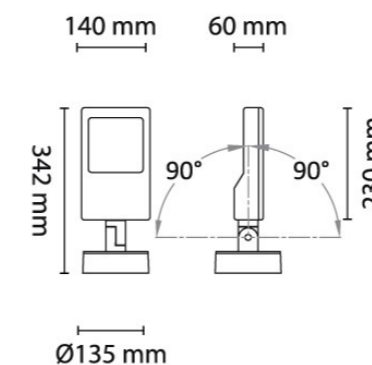

**ACCESSORIES**

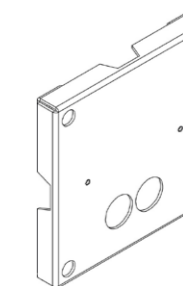

Athlon wall accessory  
e-number 45 154 09  
code 3109865

**LIGHT BEAM CURVES**

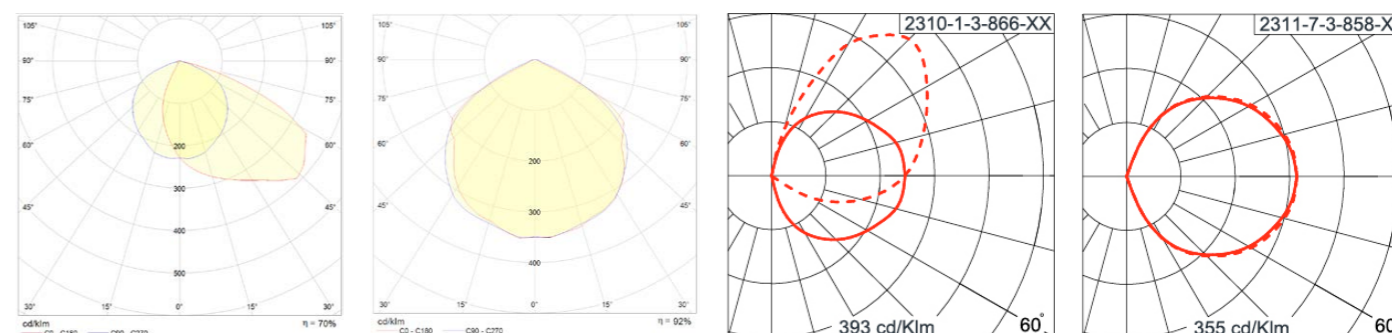

Modern floodlight with LED light sources.



**TECHNICAL DATA** **Mounting:** on the adjustable holder, on the substrate  
**Body:** high pressure die-cast aluminum  
**Lateral Surface Wind Exposed:** 0.163 m<sup>2</sup>  
**Colour:** gray  
**Diffuser:** tempered glass

**ELECTRICAL DATA** **Power supply efficiency:** >92%  
**Power:** 220-240V 50/60Hz  
**Includes light source:** yes  
**Type of equipment:** STANDARD, EASY CONNECT  
**Electrical connection:** 1,5m cable, 3x1,0mm<sup>2</sup>

**OPTICAL DATA** **Light distribution:** circular, asymmetric-narrow, asymmetric-wide  
**Way of lighting:** asymmetric, direct  
**Type of optic:** lens

**GENERAL DATA** **Lifetime (L80B10):** 100 000 h  
**Available on request:** Night dimming profile, DALI, DIM 1.10V  
**SDCM:** 5  
**Warranty:** 5 years  
**Application:** industrial facilities, warehouses, metro, parking areas, facades



OTHER PICTURES



| Electrical number                               | Code            | Beam angle        | (W) | (Lm)  | (lm/W) | (K)  | CRI/Ra | (°C)        |
|---|-----------------|-------------------|-----|-------|--------|------|--------|-------------|
| <b>High efficacy (L403 W405 H95 mm, 8,8 kg)</b> |                 |                   |     |       |        |      |        |             |
| 45 397 47                                       | 120202.5L091.41 | asymmetric-wide   | 155 | 22100 | 143    | 4000 | >70    | -40 ... +35 |
|   | 120202.5L091.11 | 25°               | 155 | 22500 | 145    | 4000 | >70    | -40 ... +35 |
|   | 120202.5L091.21 | 50°               | 155 | 22900 | 148    | 4000 | >70    | -40 ... +35 |
|   | 120202.5L091.31 | asymmetric-narrow | 155 | 23100 | 149    | 4000 | >70    | -40 ... +35 |

120202.5L011.1

- Type of equipment
  - 1 Standard
  - 2 Easy connect

**Also available in following colours**

- Black (RAL 9005)
- White (RAL 9010)

Class can be painted also

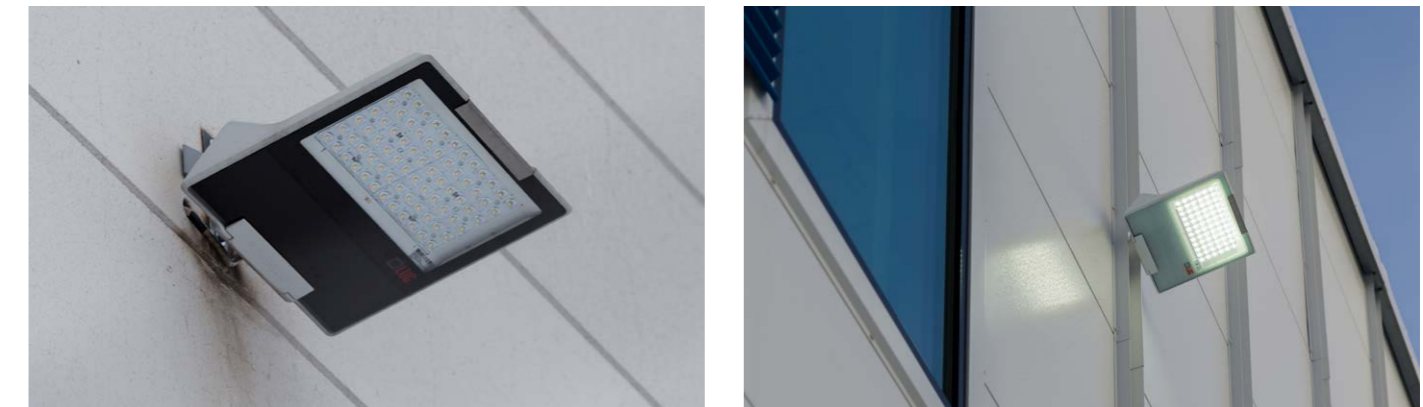

DIMENSIONAL DRAWING

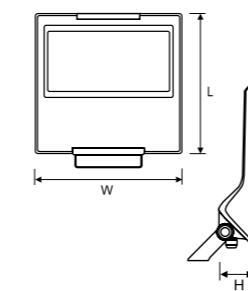

LIGHT BEAM CURVES

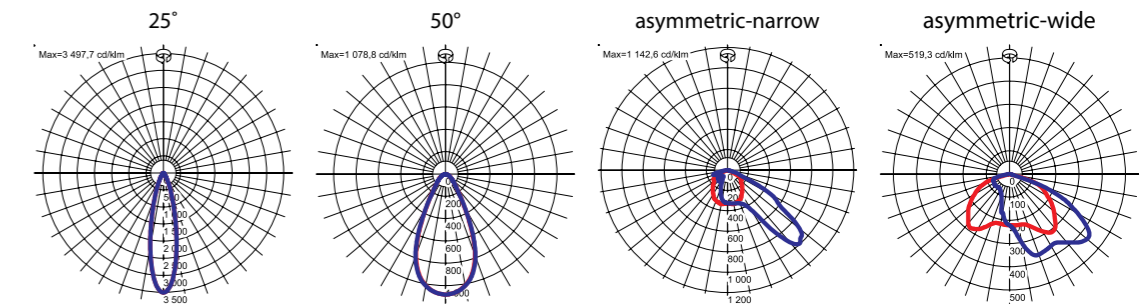

Modern floodlight with LED light sources.

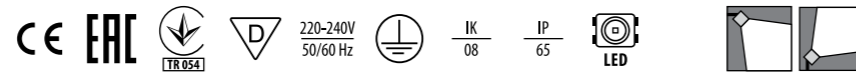

**TECHNICAL DATA** **Mounting:** on the adjustable holder, on the substrate  
**Body:** high pressure die-cast aluminum  
**Colour:** gray  
**Diffuser:** tempered glass

**ELECTRICAL DATA** **Power supply efficiency:** >85%  
**Power:** 220-240V 50/60Hz  
**Includes light source:** yes  
**Type of equipment:** ON/OFF

**OPTICAL DATA** **Electrical connection:** max 3x1 mm<sup>2</sup> wire with a length of 40 cm  
**Light distribution:** circular, asymmetric-narrow, asymmetric-wide  
**Way of lighting:** asymmetric, direct  
**Type of optic:** lens

**GENERAL DATA** **Lifetime (L80B10):** 100 000 h  
**Available on request:** DALI, DIM 1.10V  
**Additional equipment:** additional anti-corrosive protection (index extension: .985)  
**Other remarks:** IP68 connector required  
**SDCM:** 5  
**Warranty:** 5 years  
**Application:** building facades, facades, parking areas, sport facilities, industrial facilities, warehouses



**OTHER PICTURES**

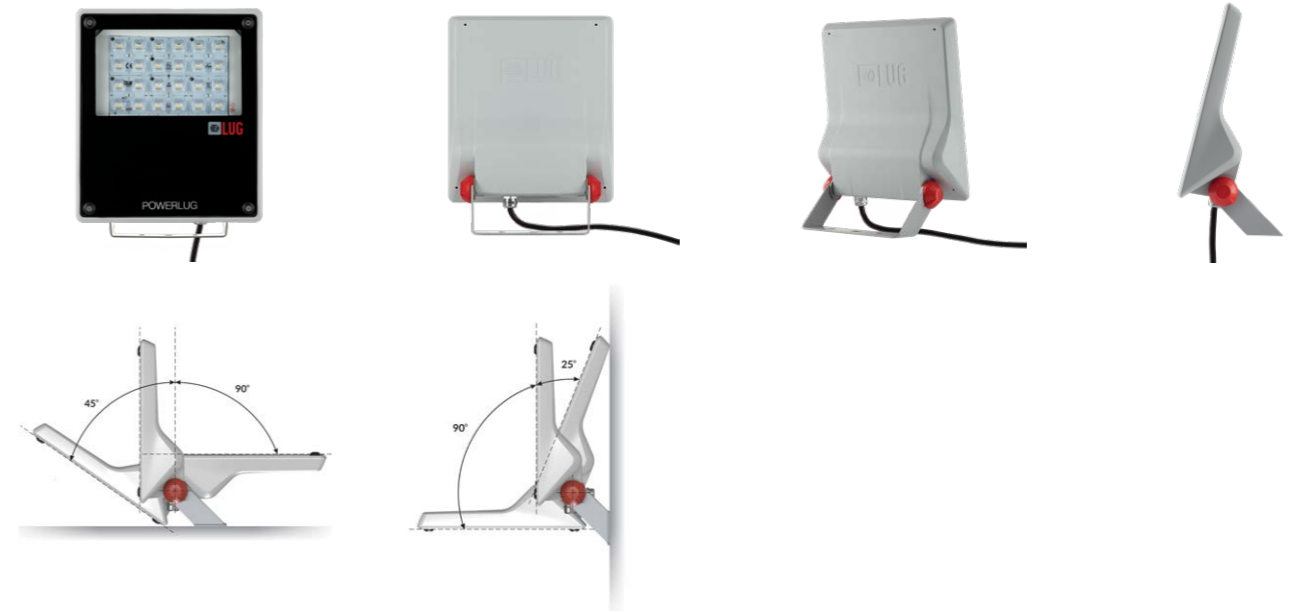

**LIGHT BEAM CURVES**

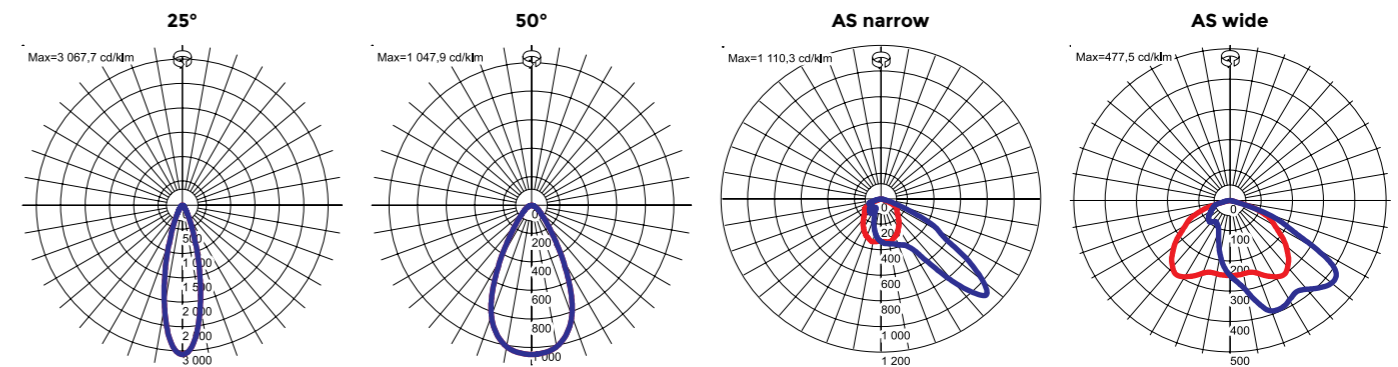

| Electrical number  | Code            | (W) | (Lm) | (lm/W) | (K)  | CRI/Ra | (°C)        |
|--|-----------------|-----|------|--------|------|--------|-------------|
| <b>High efficacy (L272 W238 H73 mm, 3,5 kg / 3,8 kg / 3,9 kg)</b>      |                 |     |      |        |      |        |             |
| 45 397 49  | 120212.5L171.41 | 25  | 3800 | 152    | 4000 | >70    | -40 ... +50 |
| 45 397 50  | 120212.5L181.41 | 44  | 6350 | 144    | 4000 | >70    | -40 ... +50 |
| 45 397 51  | 120212.5L191.41 | 54  | 7550 | 140    | 4000 | >70    | -40 ... +40 |
| 45 397 52  | 120212.5L201.41 | 67  | 9500 | 142    | 4000 | >70    | -40 ... +40 |
| <b>Standard luminaire (L272 W238 H73 mm, 3,5 kg / 3,8 kg / 3,9 kg)</b> |                 |     |      |        |      |        |             |
|  | 120212.5L011.X1 | 25  | 3450 | 138    | 4000 | >70    | -40 ... +50 |
|  | 120212.5L021.X1 | 25  | 3450 | 138    | 5700 | >70    | -40 ... +50 |
|  | 120212.5L041.X1 | 44  | 5800 | 132    | 4000 | >70    | -40 ... +50 |
|  | 120212.5L051.X1 | 44  | 5800 | 132    | 5700 | >70    | -40 ... +50 |
|  | 120212.5L071.X1 | 54  | 6750 | 125    | 4000 | >70    | -40 ... +40 |
|  | 120212.5L081.X1 | 54  | 6750 | 125    | 5700 | >70    | -40 ... +40 |
|  | 120212.5L101.X1 | 67  | 8100 | 121    | 4000 | >70    | -40 ... +40 |
|  | 120212.5L111.X1 | 67  | 8100 | 121    | 5700 | >70    | -40 ... +40 |

**DIMENSIONAL DRAWING**

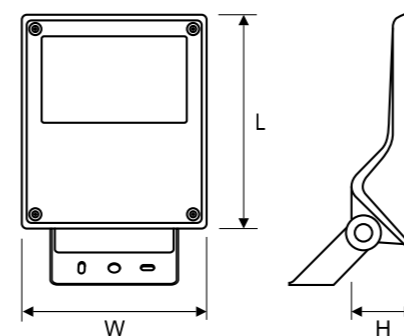

**ACCESSORIES**



**150160.00924**  
IP68 hermetic connector

**OTHER PROJECTS**



**Eksjöhus**  
Sweden

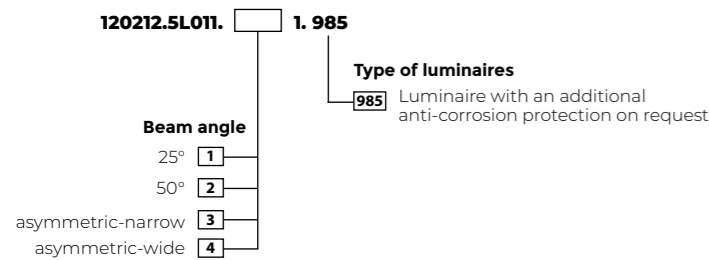

**Also available in following colours**  
■ Black (RAL 9005)  
□ White (RAL 9010)  
Class can be painted also

With these powerful floodlights you can make a nice arealighting with minimal glare. Asymmetric optic allows you to mount the Floods towards a ground and still the whole area has enough lite. Long lifetime gives you a cost-effective solution.

- TECHNICAL DATA** **Mounting:** on the adjustable holder, on the substrate
- Body:** high pressure die-cast aluminum
- Colour:** grey
- ELECTRICAL DATA** **Includes light source:** YES
- Type of equipment:** ON/OFF
- Electrical connection:** 1 m cable, 3x2,5mm<sup>2</sup>
- OPTICAL DATA** **Type of optic:** lens
- Way of lighting:** asymmetric
- GENERAL DATA** **Lifetime (L80B10):** 100 000 h
- SDCM:** 5
- Warranty:** 5 years



**OTHER PICTURES**



**DIMENSIONAL DRAWING**

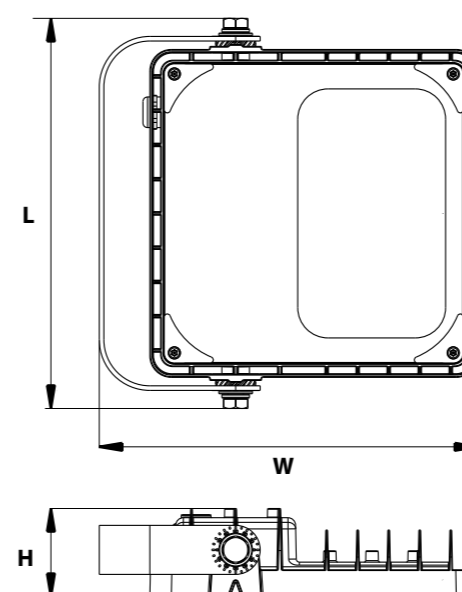

| Electrical number | (IP) | (W) | (Lm)  | (lm/W) | (K)  | CRI/Ra | (°C)         | Weight | Measurements L/W/H (mm) |
|-------------------|------|-----|-------|--------|------|--------|--------------|--------|-------------------------|
| <b>Flood</b>      |      |     |       |        |      |        |              |        |                         |
| 45 425 17         | IP66 | 53  | 6200  | 117    | 4000 | 70     | -25...+25 °C | 2,1 kg | 255/247/57              |
| 45 425 18         | IP66 | 105 | 12500 | 119    | 4000 | 70     | -25...+25 °C | 2,8 kg | 286/301/64              |
| 45 425 19         | IP66 | 151 | 18750 | 124    | 4000 | 70     | -25...+25 °C | 3,8 kg | 318/343/66              |
| 45 425 20         | IP66 | 200 | 25000 | 125    | 4000 | 70     | -25...+25 °C | 4,8 kg | 368/398/69              |
| 45 425 21         | IP66 | 300 | 37000 | 123    | 4000 | 70     | -25...+25 °C | 7,4 kg | 426/444/76              |

**LIGHT BEAM CURVES**

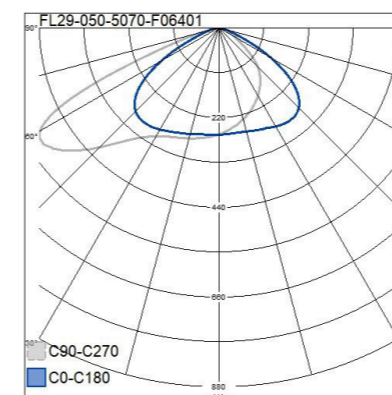

Sirocco is a well designed and powerful floodlight with asymmetric light distribution, for wall mounting. The luminaire comes complete with integrated LED and built-in LED driver and is suitable both as a façade light or for lighting up larger areas such as parking spaces and outdoor areas.

Solid cast aluminium construction with tempered safety glass. Specially treated with Unilamp's special ASC surface treatment for aggressive environments - a 16 step process topped with special varnish. The luminaire head can be angled. Sirocco can also be supplied with mast top attachment and various alternative light distributions.

Also available in 3000K colour temperature.

|                        |                                       |
|------------------------|---------------------------------------|
| <b>TECHNICAL DATA</b>  | <b>Mounting:</b> wall                 |
|                        | <b>Body:</b> polycarbonate            |
|                        | <b>Colour:</b> graphite               |
| <b>ELECTRICAL DATA</b> | <b>Includes light source:</b> YES     |
|                        | <b>Power:</b> 230V 50-60Hz            |
|                        | <b>Type of equipment:</b> ON/OFF      |
| <b>OPTICAL DATA</b>    | <b>Light distribution:</b> asymmetric |
|                        | <b>Way of lighting:</b> direct        |
| <b>GENERAL DATA</b>    | <b>Lifetime (L70B10):</b> 50 000 h    |
|                        | <b>SDCM:</b> 3                        |
|                        | <b>Warranty:</b> 5 years              |



| Electrical number | Code    | (IP) | (W) | (Lm) | (lm/W) | (K)  | CRI | Width/height/depth (mm) |
|-------------------|---------|------|-----|------|--------|------|-----|-------------------------|
| <b>Sirocco</b>    |         |      |     |      |        |      |     |                         |
| 45 154 62         | 3109492 | 65   | 57  | 6352 | 116    | 4000 | 80  | 345/118/510             |

**Also available in following colours**

- Black (RAL 9005)
- Graphite (RAL 7016)
- Dark Grey (RAL 7037)
- Aluminium Silver (RAL 9006)
- White (RAL 9010)

**OTHER PICTURES**



**DIMENSIONAL DRAWING**

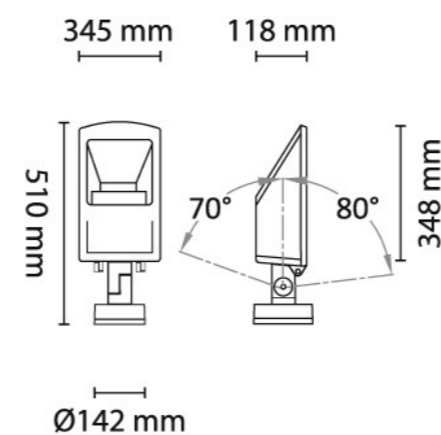

**LIGHT BEAM CURVES**

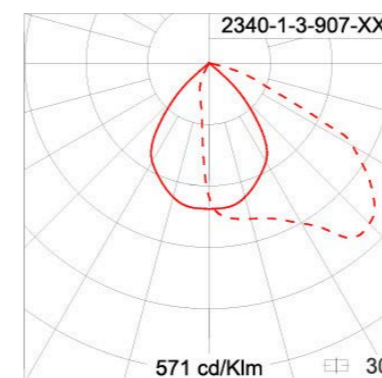

FlowerPower is a garden spot with earth spikes. The spotlight is tucked straight into soil and is ideal for lighting up shrubs and smaller trees. FlowerPower is dimmable to low level so you can set the mood in the garden yourself.

Powerful aluminium frame ensures long durability of the luminaire. The luminaire head can be angled up and down. FlowerPower comes complete with 5W GU10 light source 3000K and 2 meter rubber cable.

- TECHNICAL DATA** Mounting: ground
- Body: aluminium
- Colour: black
- ELECTRICAL DATA** Includes light source: YES, GU10
- Power: 230V 50-60Hz
- Type of equipment: triac dimming
- OPTICAL DATA** Light distribution: symmetric
- Way of lighting: direct
- GENERAL DATA** SDCM: 4
- Warranty: 5 years



| Electrical number | Code    | (W) | (Lm) | (lm/W) | (K)  | Width/height/Depth (mm) |
|-------------------|---------|-----|------|--------|------|-------------------------|
| Flowerpower       |         |     |      |        |      |                         |
| 45 175 15         | 3109547 | 5   | 350  | 70     | 3000 | 422/97/70               |

**OTHER PICTURES**



**DIMENSIONAL DRAWING**

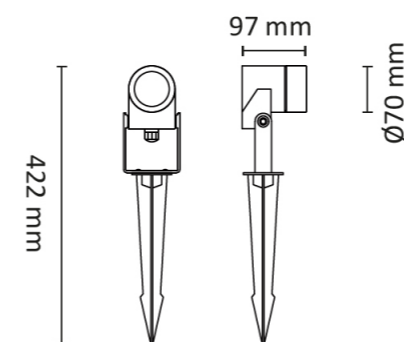



**AVENIDA**  
(page 254)

Park luminaire in modern form with LED light sources.



**TECHNICAL DATA**  
**Mounting:** on pillar ø60mm  
**Body:** high pressure die-cast aluminum  
**Lateral Surface Wind Exposed:** 0,088 m<sup>2</sup>  
**Colour:** graphite, gray  
**Diffuser:** polycarbonate

**ELECTRICAL DATA**  
**Power supply efficiency:** >89%  
**Power:** 220-240V 50/60Hz  
**Includes light source:** yes  
**Type of equipment:** ON/OFF, DALI

**OPTICAL DATA**  
**Electrical connection:** luminaire equipped with 2x1,5 mm<sup>2</sup> wire with a length of 6 m (II class), luminaire equipped with 4x1,5 mm<sup>2</sup> wire with a length of 6 m (II class)  
**Light distribution:** omnidirectional  
**Way of lighting:** direct  
**Type of optic:** O17 - for pedestrian zones

**GENERAL DATA**  
**Lifetime (L80B10):** 100 000 h  
**Available on request:** night dimming profile, twilight sensor, 10kV surge protection, NTC, Zhaga connector  
**Other remarks:** the pole is not part of the luminaire  
**SDCM:** 3  
**Warranty:** 5 years  
**Application:** avenues, sidewalks, parks, residential, public spaces, playgrounds, promenade, residential area roads



| Electrical number                                    | Code                 | Colour   | (W) | (Lm) | (lm/W) | (K)  | CRI/Ra | (°C)        |
|--|----------------------|----------|-----|------|--------|------|--------|-------------|
| <b>Standard luminaire (L360 S76 H482 mm, 4,4 kg)</b> |                      |          |     |      |        |      |        |             |
| 45 397 16  | 130265.5L022.011.861 | Graphite | 19  | 2500 | 132    | 4000 | >80    | -40 ... +55 |
| 45 397 17  | 130265.5L052.011.861 | Graphite | 27  | 3500 | 130    | 4000 | >80    | -40 ... +55 |
| 45 397 18  | 130265.5L082.011.861 | Graphite | 34  | 4400 | 129    | 4000 | >80    | -40 ... +55 |

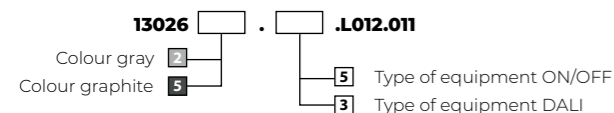

**Also available in following colours**

- Black (RAL 9005)
- White (RAL 9010)
- All RAL colours

OTHER PICTURES



Gray



Graphite Modern hat



Gray Modern hat



DIMENSIONAL DRAWING

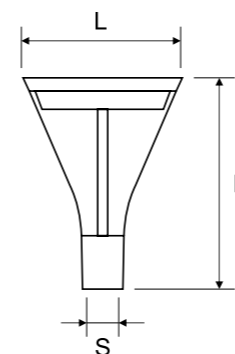

LIGHT BEAM CURVES

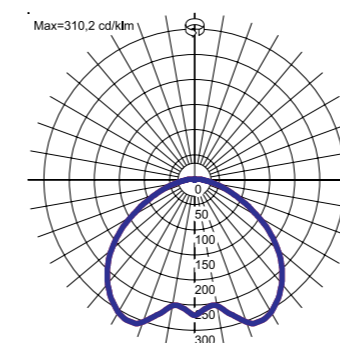

130262.5L082.011



Park luminaire in modern form with LED light sources.



**TECHNICAL DATA**

**Mounting:** on pillar ø60mm  
**Body:** high pressure die-cast aluminum  
**Lateral Surface Wind Exposed:** 0,088 m<sup>2</sup>  
**Colour:** graphite, gray  
**Diffuser:** polycarbonate

**ELECTRICAL DATA**

**Power supply efficiency:** >89%  
**Power:** 220-240V 50/60Hz  
**Includes light source:** yes  
**Type of equipment:** DALI, ON/OFF

**OPTICAL DATA**

**Electrical connection:** luminaire equipped with 4x1,5 mm<sup>2</sup> wire with a length of 6 m (II class), luminaire equipped with 2x1,5 mm<sup>2</sup> wire with a length of 6 m (II class)  
**Light distribution:** symmetrical-elliptical, omnidirectional  
**Way of lighting:** direct  
**Type of optic:** O18 - for pedestrian zones, O19 - for recreational areas, O20 - for parks and parking lots, O21 - for bike paths, O22 - for pedestrian zones, O23 - for recreational areas, O24 - for parks and parking lots, O25 - for bike paths, O28 - for pedestrian zones, O29 - for recreational areas, O30 - for parks and parking lots, O31 - for bike paths



**GENERAL DATA**

**Lifetime (L90B10):** 100 000 h  
**Available on request:** DALI, Night dimming profile, twilight sensor, 10kV surge protection, NTC, Zhaga connector  
**SDCM:** 5  
**Warranty:** 5 years  
**Application:** cycle paths, avenues, sidewalks, parks, residential, public spaces, playgrounds, promenade, residential area roads

| Electrical number  | Code                 | Optics | (W) | (Lm) | (lm/W) | (K)  | CRI/Ra | (°C)        |
|--|----------------------|--------|-----|------|--------|------|--------|-------------|
| <b>Standard luminaire - O18, O19, O20, O21 optics (L360 S76 H482 mm, 4,4 kg)</b> |                      |        |     |      |        |      |        |             |
| 45 397 09  | 130275.5L082.021.861 | O19    | 35  | 4200 | 120    | 4000 | >70    | -40 ... +55 |
| 45 397 10  | 130275.5L082.031.861 | O20    | 35  | 4200 | 120    | 4000 | >70    | -40 ... +55 |
| 45 397 11  | 130275.5L082.041.861 | O21    | 35  | 4200 | 120    | 4000 | >70    | -40 ... +55 |
| 45 397 12  | 130275.5L112.051.861 | O22    | 35  | 4600 | 131    | 4000 | >70    | -40 ... +55 |
| 45 397 13  | 130275.5L112.061.861 | O23    | 35  | 4650 | 133    | 4000 | >70    | -40 ... +50 |
| 45 397 14  | 130275.5L112.071.861 | O24    | 35  | 4650 | 133    | 4000 | >70    | -40 ... +50 |
| 45 397 15  | 130275.5L112.081.861 | O25    | 35  | 4650 | 133    | 4000 | >70    | -40 ... +50 |
| 45 397 53  | 130275.5L142.051.861 | O22    | 49  | 6350 | 130    | 4000 | >70    | -40 ... +50 |
| 45 397 54  | 130275.5L142.061.861 | O23    | 49  | 6300 | 129    | 4000 | >70    | -40 ... +50 |
| 45 397 55  | 130275.5L142.071.861 | O24    | 49  | 6350 | 130    | 4000 | >70    | -40 ... +50 |
| 45 397 56  | 130275.5L142.081.861 | O25    | 49  | 6200 | 127    | 4000 | >70    | -40 ... +50 |

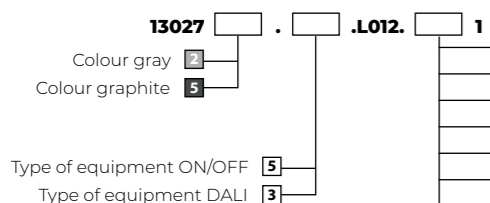

- Type of optic**
- 01 O18 - for pedestrian zones
  - 02 O19 - for recreational areas
  - 03 O20 - for parks and parking lots
  - 04 O21 - for bike paths
  - 05 O22 - for pedestrian zones
  - 06 O23 - for recreational areas
  - 07 O24 - for parks and parking lots
  - 08 O25 - for bike paths
  - 11 O28 - for pedestrian zones
  - 12 O29 - for recreational areas
  - 13 O30 - for parks and parking lots
  - 14 O31 - for bike paths

**Also available in following colours**

- Black (RAL 9005)
- White (RAL 9010)
- All RAL colours

**OTHER PICTURES**



**DIMENSIONAL DRAWING**

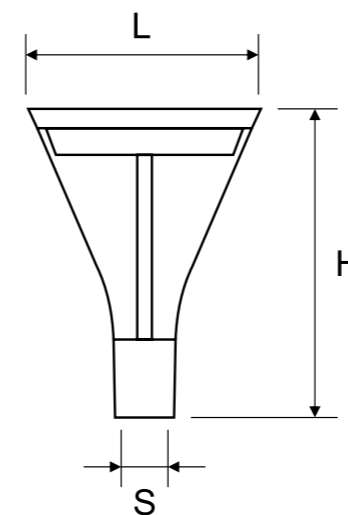

**LIGHT BEAM CURVES**

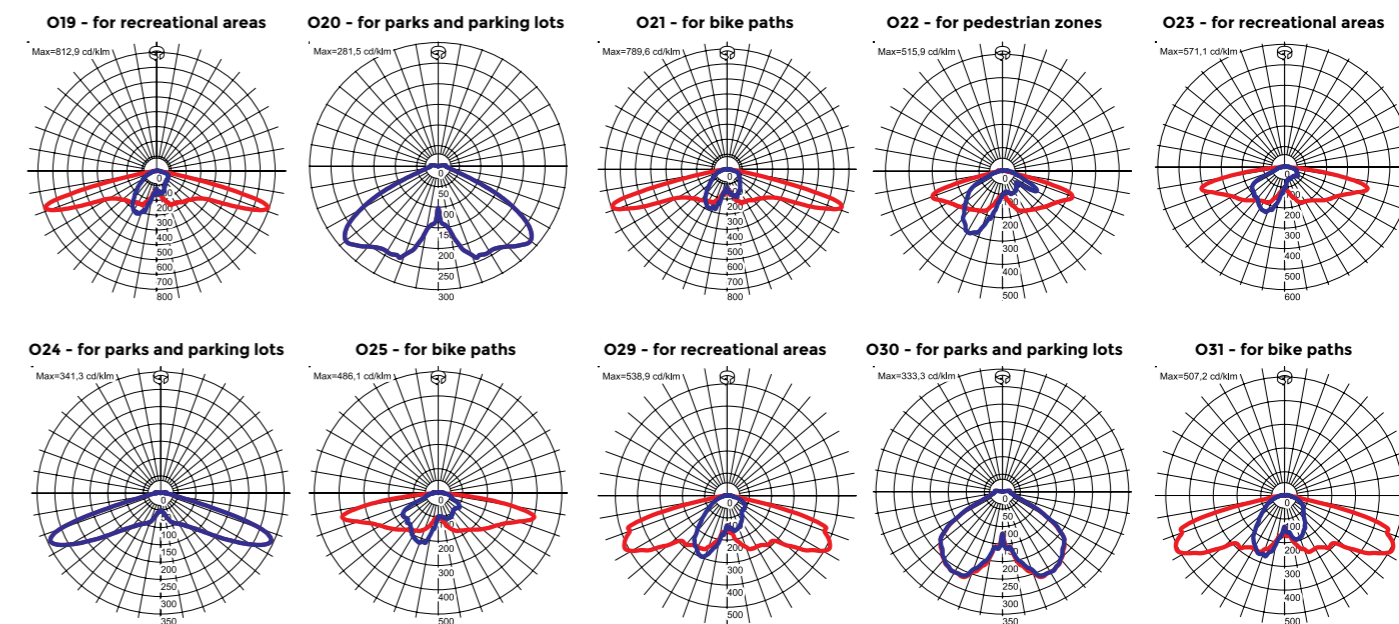

Stylized park luminaire, based on the architecture of AVENIDA LED luminaires and referring in character to classic decorative luminaires.

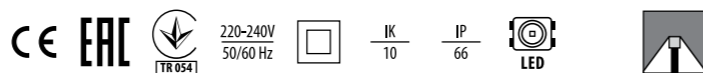

- TECHNICAL DATA**  
**Mounting:** on pillar ø60/76mm, with mounting bracket (included)  
**Body:** high pressure die-cast aluminum  
**Lateral Surface Wind Exposed:** 0,088 m<sup>2</sup>  
**Colour:** graphite, gray  
**Diffuser:** polycarbonate
- ELECTRICAL DATA**  
**Power supply efficiency:** >89%  
**Power:** 220-240V 50/60Hz  
**Includes light source:** yes  
**Type of equipment:** DALI, ON/OFF  
**Electrical connection:** luminaire equipped with 2x1,5 mm<sup>2</sup> wire with a length of 6 m (II class) - P version
- OPTICAL DATA**  
**Light distribution:** omnidirectional  
**Way of lighting:** direct  
**Type of optic:** diffuser  
**ULOR / DLOR:** 2/98, 2,3/97,7, 2,2/97,8
- GENERAL DATA**  
**Lifetime (L80B10):** 100 000 h  
**Available on request:** DALI, 10kV surge protection, NTC, night dimming profile  
**Other remarks:** the pole is not part of the luminaire  
**Warranty:** 5 years  
**Application:** avenues, sidewalks, parks, residential, public spaces, Railway stations, facades, promenade, roads, residential area roads



**OTHER PICTURES**



Gray

**DIMENSIONAL DRAWING**

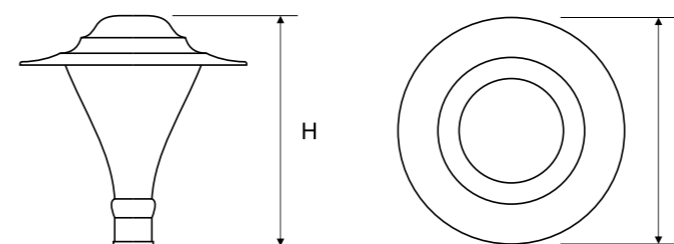

**LIGHT BEAM CURVES**

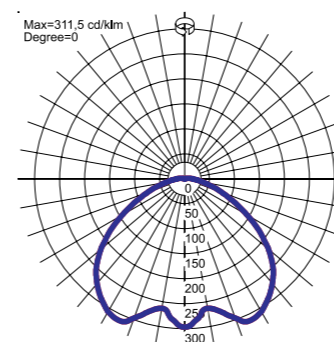

130325.5L012.011

**ACCESSORIES**



Graphite 150175.00982  
Gray 150172.00966



Graphite 150245.01095  
Gray 150242.01094

| Electrical number                            | Code             | (W) | (Lm) | (lm/W) | (K)  | CRI/Ra | (°C)        |
|--|------------------|-----|------|--------|------|--------|-------------|
| <b>Heritage P (L561 S76 H570 mm, 6,2 kg)</b> |                  |     |      |        |      |        |             |
|  | 13032X.XL012.011 | 19  | 2350 | 124    | 3000 | >80    | -40 ... +55 |
|  | 13032X.XL022.011 | 19  | 2500 | 132    | 4000 | >80    | -40 ... +55 |
|  | 13032X.XL042.011 | 27  | 3350 | 124    | 3000 | >80    | -40 ... +55 |
|  | 13032X.XL052.011 | 27  | 3500 | 130    | 4000 | >80    | -40 ... +55 |
|  | 13032X.XL072.011 | 34  | 4250 | 125    | 3000 | >80    | -40 ... +50 |
|  | 13032X.XL082.011 | 34  | 4400 | 129    | 4000 | >80    | -40 ... +50 |

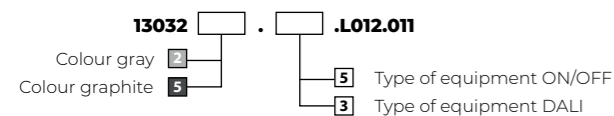

- Also available in following colours**
- Black (RAL 9005)
  - White (RAL 9010)
  - All RAL colours

Stylized park luminaire, based on the architecture of AVENIDA LED luminaires and referring in character to classic decorative luminaires.

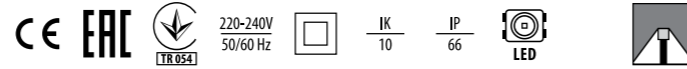

- TECHNICAL DATA**
  - Mounting:** on pillar ø60/76mm, with mounting bracket (included)
  - Body:** high pressure die-cast aluminum
  - Lateral Surface Wind Exposed:** 0,088 m<sup>2</sup>
  - Colour:** graphite, gray
  - Diffuser:** polycarbonate
- ELECTRICAL DATA**
  - Power supply efficiency:** >89%
  - Power:** 220-240V 50/60Hz
  - Includes light source:** yes
  - Type of equipment:** DALI, ON/OFF
  - Electrical connection:** luminaire equipped with 2x1,5 mm<sup>2</sup> wire with a length of 6 m (II class) - P version
- OPTICAL DATA**
  - Light distribution:** symmetrical-elliptic
  - Way of lighting:** direct
  - Type of optic:** O18 - for pedestrian zones, O19 - for recreational areas, O20 - for parks and parking lots, O21 - for bike paths, O22 - for pedestrian zones, O23 - for recreational areas, O24 - for parks and parking lots, O25 - for bike paths
- GENERAL DATA**
  - Lifetime (L90B10):** 100 000 h
  - Available on request:** DALI, 10kV surge protection, NTC, night dimming profile
  - Other remarks:** the pole is not part of the luminaire
  - Warranty:** 5 years
  - Application:** avenues, sidewalks, parks, residential, public spaces, Railway stations, facades, promenade, roads, residential area roads



| Electrical number   | Code             | (W) | (Lm) | (lm/W) | (K)  | CRI/Ra | (°C)        |
|---|------------------|-----|------|--------|------|--------|-------------|
| <b>Heritage LENS P - O18, O19, O20, O21 optics (L561 S76 H570 mm, 6,2 kg)</b> |                  |     |      |        |      |        |             |
|   | 13033X.XL012.XX1 | 18  | 2200 | 122    | 3000 | >70    | -40 ... +55 |
|   | 13033X.XL022.XX1 | 18  | 2300 | 128    | 4000 | >70    | -40 ... +55 |
|   | 13033X.XL042.XX1 | 25  | 3000 | 120    | 3000 | >70    | -40 ... +55 |
|   | 13033X.XL052.XX1 | 25  | 3200 | 128    | 4000 | >70    | -40 ... +55 |
|   | 13033X.XL072.XX1 | 35  | 4000 | 114    | 3000 | >70    | -40 ... +50 |
|   | 13033X.XL082.XX1 | 35  | 4200 | 120    | 4000 | >70    | -40 ... +50 |
| <b>Heritage LENS P - O22, O23, O24, O25 optics (L561 S76 H570 mm, 6,2 kg)</b> |                  |     |      |        |      |        |             |
|   | 13033X.XL102.XX1 | 35  | 4450 | 127    | 3000 | >70    | -40 ... +50 |
|   | 13033X.XL112.XX1 | 35  | 4600 | 131    | 4000 | >70    | -40 ... +50 |
|   | 13033X.XL132.XX1 | 49  | 6050 | 123    | 3000 | >70    | -40 ... +45 |
|   | 13033X.XL142.XX1 | 49  | 6350 | 130    | 4000 | >70    | -40 ... +45 |

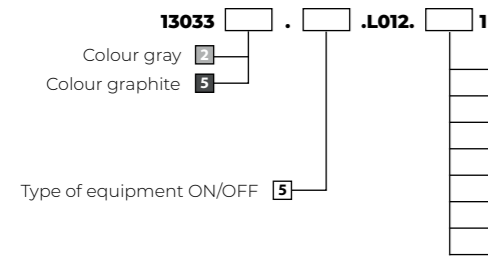

- Type of optic**
- 01** O18 - for pedestrian zones
  - 02** O19 - for recreational areas
  - 03** O20 - for parks and parking lots
  - 04** O21 - for bike paths
  - 05** O22 - for pedestrian zones
  - 06** O23 - for recreational areas
  - 07** O24 - for parks and parking lots
  - 08** O25 - for bike paths

- Also available in following colours**
- Black (RAL 9005)
  - White (RAL 9010)
  - All RAL colours

**OTHER PICTURES**



Gray

**DIMENSIONAL DRAWING**

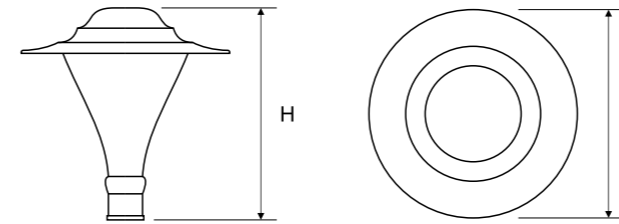

**ACCESSORIES**



Graphite 150175.00982  
Gray 150172.00966



Graphite 150245.01095  
Gray 150242.01094

**LIGHT BEAM CURVES**

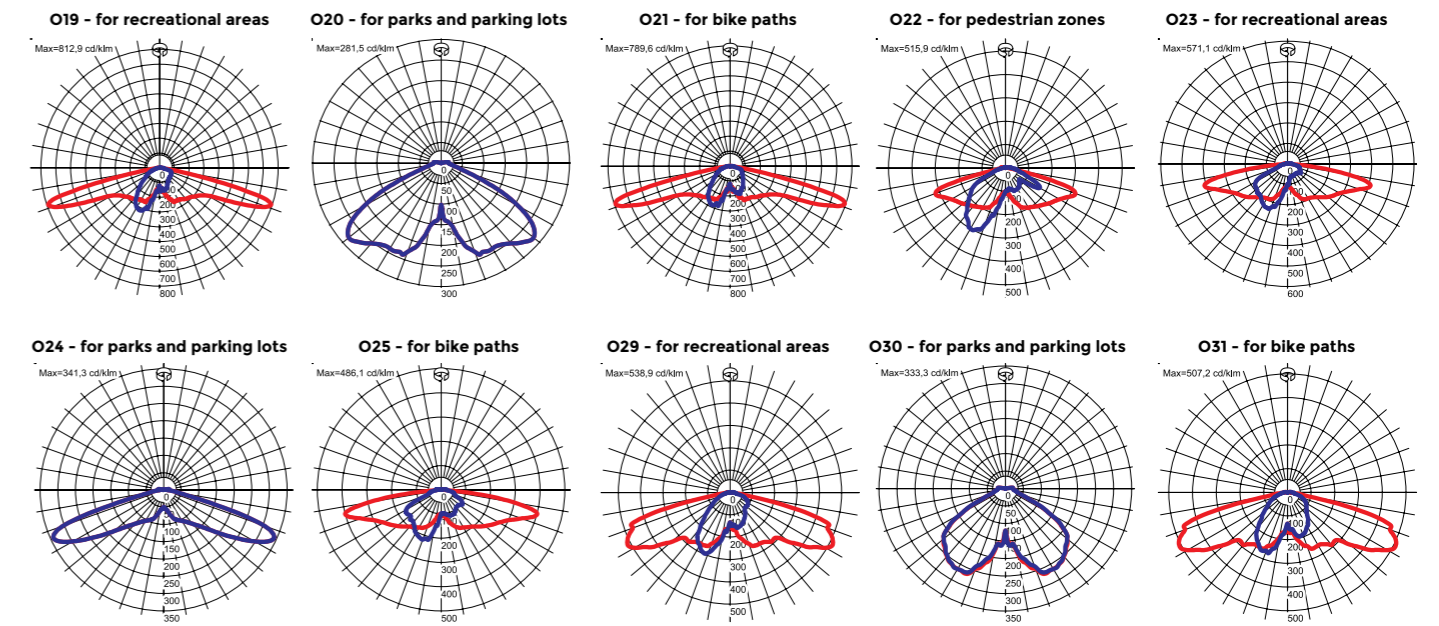

Stylized park luminaire, based on the architecture of AVENIDA LED luminaires and referring in character to classic decorative luminaires.

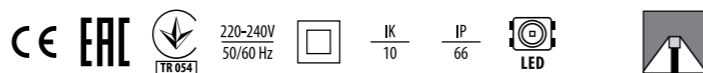

- TECHNICAL DATA**
  - Mounting:** catenary, on a ø6-15mm diameter cable
  - Body:** high pressure die-cast aluminum
  - Lateral Surface Wind Exposed:** 0,088 m<sup>2</sup>
  - Colour:** graphite, gray
  - Diffuser:** polycarbonate
- ELECTRICAL DATA**
  - Power supply efficiency:** >89%
  - Power:** 220-240V 50/60Hz
  - Includes light source:** yes
  - Type of equipment:** DALI, ON/OFF
  - Electrical connection:** luminaire equipped with 2x1.5 mm<sup>2</sup> wire with a length of 80 cm - C version
- OPTICAL DATA**
  - Light distribution:** omnidirectional
  - Way of lighting:** direct
  - Type of optic:** diffuser
- GENERAL DATA**
  - Lifetime (L80B10):** 100 000 h
  - Available on request:** DALI, 10kV surge protection, NTC, night dimming profile
  - Warranty:** 5 years
  - Application:** avenues, sidewalks, parks, residential, public spaces, Railway stations, facades, promenade, roads, residential area roads



| Electrical number                                | Code             | (W) | (Lm) | (lm/W) | (K)  | CRI/Ra | (°C)        |
|--|------------------|-----|------|--------|------|--------|-------------|
| <b>Heritage LED C (L561 S76 H536 mm, 6,7 kg)</b> |                  |     |      |        |      |        |             |
|  | 13032X.XL012.013 | 19  | 2350 | 124    | 3000 | >80    | -40 ... +55 |
|  | 13032X.XL022.013 | 19  | 2500 | 132    | 4000 | >80    | -40 ... +55 |
|  | 13032X.XL042.013 | 27  | 3350 | 124    | 3000 | >80    | -40 ... +55 |
|  | 13032X.XL052.013 | 27  | 3500 | 130    | 4000 | >80    | -40 ... +55 |
|  | 13032X.XL072.013 | 34  | 4250 | 125    | 3000 | >80    | -40 ... +50 |
|  | 13032X.XL082.013 | 34  | 4400 | 129    | 4000 | >80    | -40 ... +50 |

13032 . .L012.013

Colour gray

Colour graphite

Type of equipment ON/OFF

Type of equipment DALI

- Also available in following colours**
- Black (RAL 9005)
  - White (RAL 9010)
  - All RAL colours

**OTHER PICTURES**



Gray

**DIMENSIONAL DRAWING**

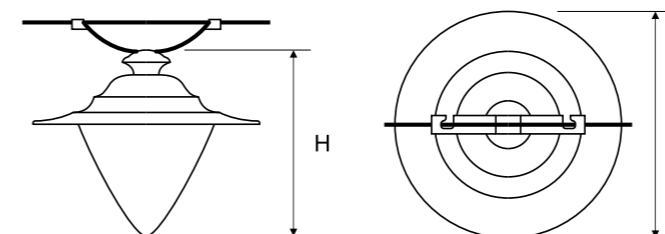

**LIGHT BEAM CURVES**

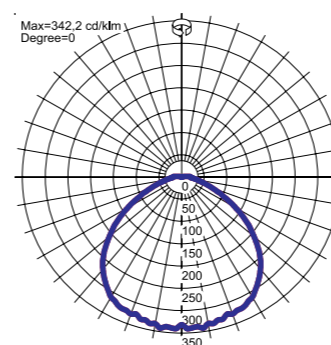

130325.5L012.013

**ACCESSORIES**



Graphite 150245.01095  
Gray 150242.01094



2 field 150170.01022  
4 field 150170.01024

Stylized park luminaire, based on the architecture of AVENIDA LED luminaires and referring in character to classic decorative luminaires.

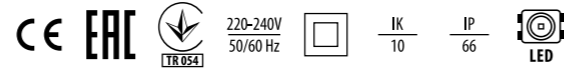

- TECHNICAL DATA**
  - Mounting:** catenary, on a ø6-15mm diameter cable
  - Body:** high pressure die-cast aluminum
  - Lateral Surface Wind Exposed:** 0,088 m<sup>2</sup>
  - Colour:** graphite, gray
  - Diffuser:** polycarbonate
- ELECTRICAL DATA**
  - Power supply efficiency:** >89%
  - Power:** 220-240V 50/60Hz
  - Includes light source:** yes
  - Type of equipment:** DALI, ON/OFF
  - Electrical connection:** luminaire equipped with 2x1.5 mm<sup>2</sup> wire with a length of 80 cm - C version
- OPTICAL DATA**
  - Light distribution:** symmetrical-elliptic
  - Way of lighting:** direct
  - Type of optic:** O32 - for pedestrian zones, O33 - for recreational areas, O34 - for parks and parking lots, O35 - for bike paths, O36 - for pedestrian zones, O37 - for recreational areas, O38 - for parks and parking lots, O39 - for bike paths
- GENERAL DATA**
  - Lifetime (L90B10):** 100 000 h
  - Available on request:** DALI, 10kV surge protection, NTC, night dimming profile
  - Warranty:** 5 years
  - Application:** avenues, sidewalks, parks, residential, public spaces, Railway stations, facades, promenade, roads, residential area roads



| Electrical number   | Code             | (W) | (Lm) | (lm/W) | (K)  | CRI/Ra | (°C)        |
|---|------------------|-----|------|--------|------|--------|-------------|
| <b>Heritage LENS LED C - O19, O26, O36 optics (L561 S42/76 H536 mm, 6,7 kg)</b> |                  |     |      |        |      |        |             |
|   | 13033X.XL012.XX3 | 19  | 2450 | 129    | 3000 | >70    | -40 ... +55 |
|   | 13033X.XL022.XX3 | 19  | 2600 | 137    | 4000 | >70    | -40 ... +55 |
|   | 13033X.XL042.XX3 | 26  | 3350 | 129    | 3000 | >70    | -40 ... +55 |
|   | 13033X.XL052.XX3 | 26  | 3550 | 137    | 4000 | >70    | -40 ... +55 |
|   | 13033X.XL072.XX3 | 36  | 4400 | 122    | 3000 | >70    | -40 ... +50 |
|   | 13033X.XL082.XX3 | 36  | 4700 | 131    | 4000 | >70    | -40 ... +50 |
| <b>Heritage LENS LED C - O35, O49 optics (L561 S42/76 H536 mm, 6,7 kg)</b>      |                  |     |      |        |      |        |             |
|   | 13033X.XL102.XX3 | 35  | 4900 | 140    | 3000 | >70    | -40 ... +50 |
|   | 13033X.XL112.XX3 | 35  | 5250 | 150    | 4000 | >70    | -40 ... +50 |
|   | 13033X.XL132.XX3 | 49  | 6600 | 135    | 3000 | >70    | -40 ... +45 |
|   | 13033X.XL142.XX3 | 49  | 7050 | 144    | 4000 | >70    | -40 ... +45 |

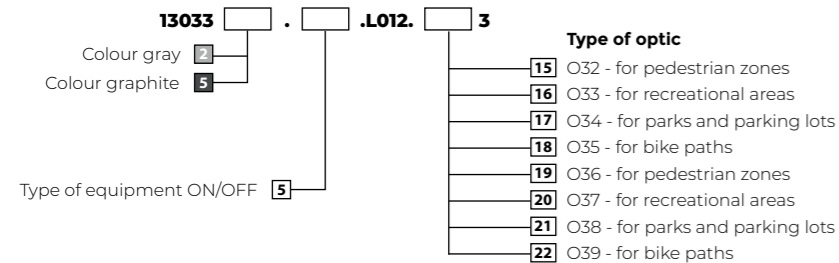

- Also available in following colours**
- Black (RAL 9005)
  - White (RAL 9010)
  - All RAL colours

## OTHER PICTURES



Gray

## DIMENSIONAL DRAWING

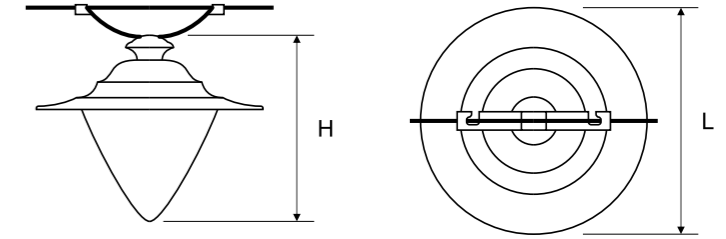

## LIGHT BEAM CURVES

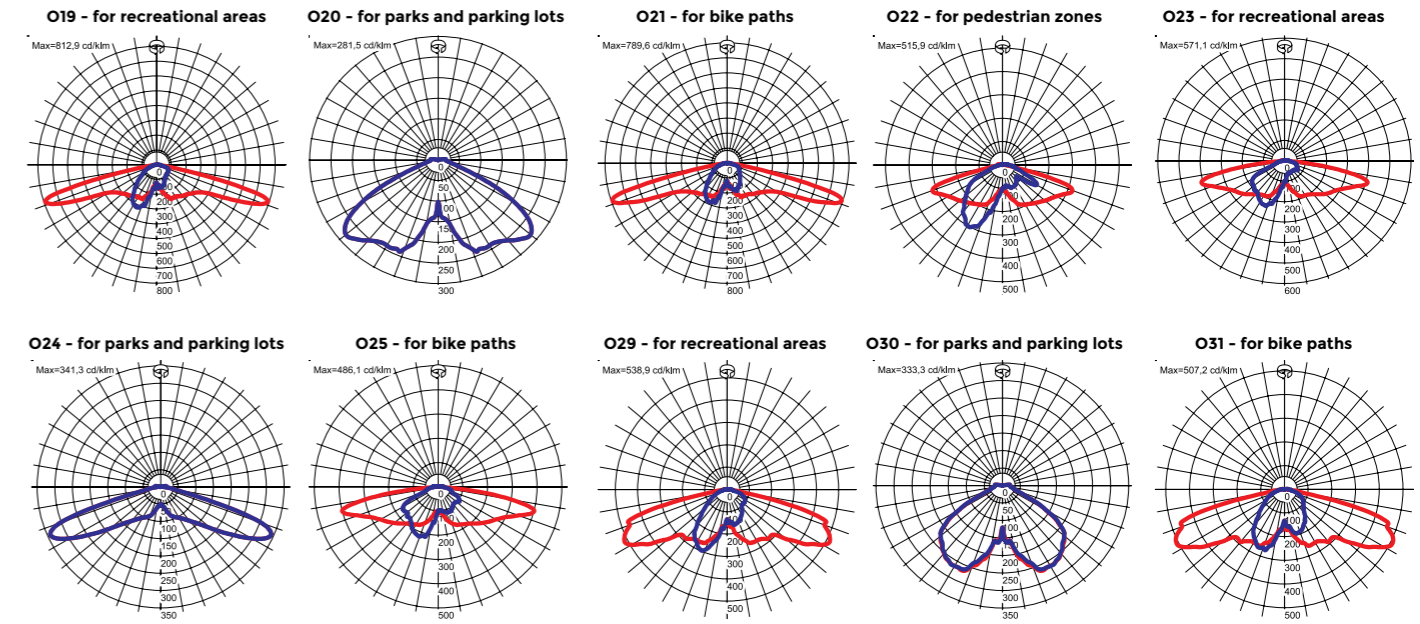

## ACCESSORIES



Graphite 150245.01095  
Gray 150242.01094



2 field 150170.01022  
4 field 150170.01024

Stylized park luminaire, based on the architecture of AVENIDA LED luminaires and referring in character to classic decorative luminaires.

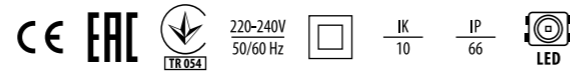

- TECHNICAL DATA**  
**Mounting:** suspended on a mounting tube with diameter  $\phi 42$   
**Body:** high pressure die-cast aluminum  
**Lateral Surface Wind Exposed:** 0,088 m<sup>2</sup>  
**Colour:** graphite, gray  
**Diffuser:** polycarbonate
- ELECTRICAL DATA**  
**Power supply efficiency:** >89%  
**Power:** 220-240V 50/60Hz  
**Includes light source:** yes  
**Type of equipment:** DALI, ON/OFF  
**Electrical connection:** luminaire equipped with 2x1,5 mm<sup>2</sup> wire with a length of 7 m - S version
- OPTICAL DATA**  
**Light distribution:** omnidirectional  
**Way of lighting:** direct  
**Type of optic:** diffuser
- GENERAL DATA**  
**Lifetime (L80B10):** 100 000 h  
**Available on request:** DALI, 10kV surge protection, NTC, night dimming profile  
**Other remarks:** the pole is not part of the luminaire  
**Warranty:** 5 years  
**Application:** avenues, sidewalks, parks, residential, public spaces, Railway stations, facades, promenade, roads, residential area roads

| Electrical number                                | Code             | (W) | (Lm) | (lm/W) | (K)  | CRI/Ra | (°C)        |
|--|------------------|-----|------|--------|------|--------|-------------|
| <b>Heritage LED S (L561 S42 H426 mm, 4,9 kg)</b> |                  |     |      |        |      |        |             |
|  | 13032X.XL012.012 | 19  | 2350 | 124    | 3000 | >80    | -40 ... +55 |
|  | 13032X.XL022.012 | 19  | 2500 | 132    | 4000 | >80    | -40 ... +55 |
|  | 13032X.XL042.012 | 27  | 3350 | 124    | 3000 | >80    | -40 ... +55 |
|  | 13032X.XL052.012 | 27  | 3500 | 130    | 4000 | >80    | -40 ... +55 |
|  | 13032X.XL072.012 | 34  | 4250 | 125    | 3000 | >80    | -40 ... +50 |
|  | 13032X.XL082.012 | 34  | 4400 | 129    | 4000 | >80    | -40 ... +50 |

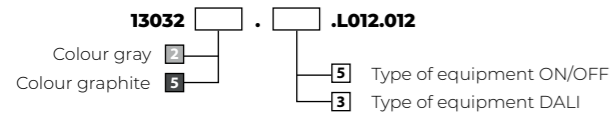

- Also available in following colours**
- Black (RAL 9005)
  - White (RAL 9010)
  - All RAL colours

**OTHER PICTURES**



Gray

**DIMENSIONAL DRAWING**

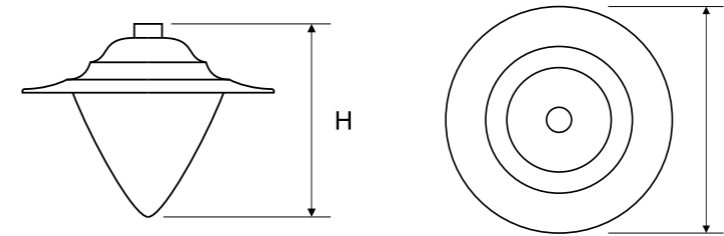

**LIGHT BEAM CURVES**

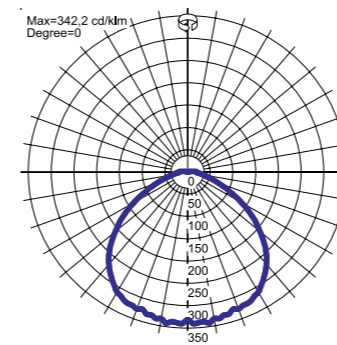

130325.5L012.012

**ACCESSORIES**



Graphite 150245.01095  
 Gray 150242.01094

Stylized park luminaire, based on the architecture of AVENIDA LED luminaires and referring in character to classic decorative luminaires.

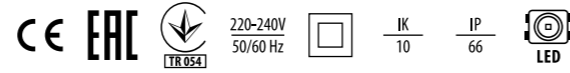

**TECHNICAL DATA**  
**Mounting:** suspended on a mounting tube with diameter  $\varnothing 42$   
**Body:** high pressure die-cast aluminum  
**Lateral Surface Wind Exposed:** 0,088 m<sup>2</sup>  
**Colour:** graphite, gray  
**Diffuser:** polycarbonate

**ELECTRICAL DATA**  
**Power supply efficiency:** >89%  
**Power:** 220-240V 50/60Hz  
**Includes light source:** yes  
**Type of equipment:** DALI, ON/OFF  
**Electrical connection:** luminaire equipped with 2x1,5 mm<sup>2</sup> wire with a length of 7 m - S version

**OPTICAL DATA**  
**Light distribution:** symmetrical-elliptic  
**Way of lighting:** direct  
**Type of optic:** O32 - for pedestrian zones, O33 - for recreational areas, O34 - for parks and parking lots, O35 - for bike paths, O36 - for pedestrian zones, O37 - for recreational areas, O38 - for parks and parking lots, O39 - for bike paths

**GENERAL DATA**  
**Lifetime (L90B10):** 100 000 h  
**Available on request:** DALI, 10kV surge protection, NTC, night dimming profile  
**Other remarks:** the pole is not part of the luminaire  
**Warranty:** 5 years  
**Application:** avenues, sidewalks, parks, residential, public spaces, Railway stations, facades, promenade, roads, residential area roads

**OTHER PICTURES**



Gray

**DIMENSIONAL DRAWING**

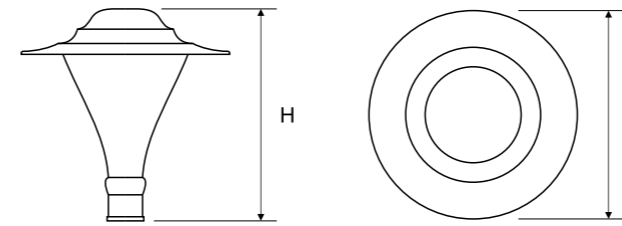

**ACCESSORIES**



Graphite 150245.01095  
 Gray 150242.01094

| Electrical number   | Code             | (W) | (Lm) | (lm/W) | (K)  | CRI/Ra | (°C)        |
|---|------------------|-----|------|--------|------|--------|-------------|
| <b>Heritage LENS LED S - O32, O33, O34, O35 optics (L561 S42 H561 mm, 4,9 kg)</b> |                  |     |      |        |      |        |             |
|   | 13033X.XL012.XX2 | 19  | 2450 | 129    | 3000 | >70    | -40 ... +55 |
|   | 13033X.XL022.XX2 | 19  | 2600 | 137    | 4000 | >70    | -40 ... +55 |
|   | 13033X.XL042.XX2 | 26  | 3350 | 129    | 3000 | >70    | -40 ... +55 |
|   | 13033X.XL052.XX2 | 26  | 3550 | 137    | 4000 | >70    | -40 ... +55 |
|   | 13033X.XL072.XX2 | 36  | 4400 | 122    | 3000 | >70    | -40 ... +50 |
|   | 13033X.XL082.XX2 | 36  | 4700 | 131    | 4000 | >70    | -40 ... +50 |
| <b>Heritage LENS LED S - O36, O37, O38, O39 optics (L561 S42 H561 mm, 4,9 kg)</b> |                  |     |      |        |      |        |             |
|   | 13033X.XL102.XX2 | 35  | 4900 | 140    | 3000 | >70    | -40 ... +50 |
|   | 13033X.XL112.XX2 | 35  | 5250 | 150    | 4000 | >70    | -40 ... +50 |
|   | 13033X.XL132.XX2 | 49  | 6600 | 135    | 3000 | >70    | -40 ... +45 |
|   | 13033X.XL142.XX2 | 49  | 7050 | 144    | 4000 | >70    | -40 ... +45 |

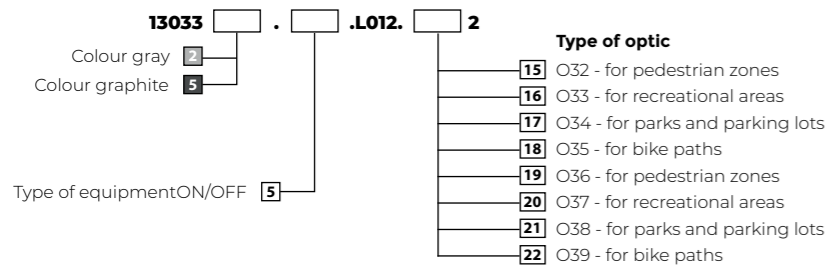

**Also available in following colours**

- Black (RAL 9005)
- White (RAL 9010)
- All RAL colours

**LIGHT BEAM CURVES**

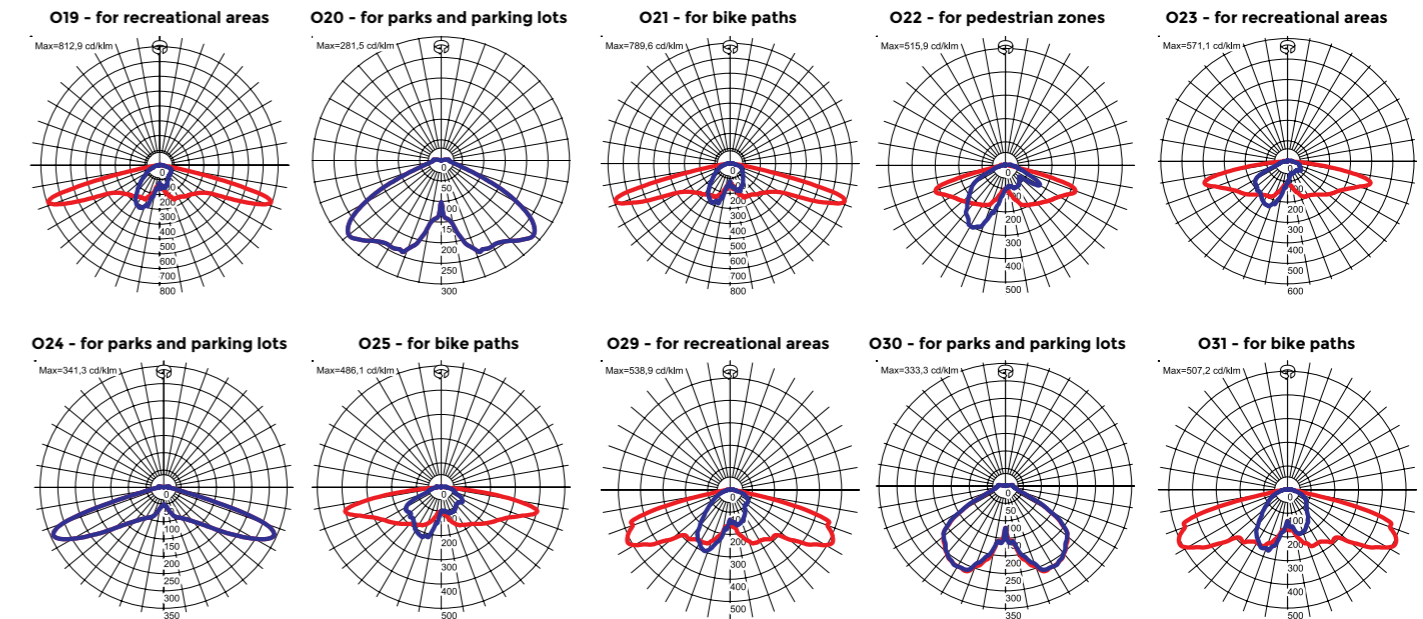

Modern urban-park luminaire with LED light sources. Multiple mounting options and distinctive design. Available multiple accessories.

**TECHNICAL DATA** **Mounting:** on pillar, on outriggers, with mounting brackets (on request)  
**Body:** high pressure die-cast aluminum  
**Lateral Surface Wind Exposed:** 0.048 m<sup>2</sup>  
**Colour:** gray, graphite  
**Diffuser:** tempered glass

**ELECTRICAL DATA** **Power supply efficiency:** 90%  
**Power:** 220-240V 50/60Hz  
**Includes light source:** yes  
**Type of equipment:** DALI, ON/OFF  
**Electrical connection:** max 4x1,5 mm<sup>2</sup> wire, max 2x1,5 mm<sup>2</sup> wire

**OPTICAL DATA** **Way of lighting:** direct  
**Type of optic:** O2 - for express roads, O3 - for local roads, O4 - for town roads, O5 - for residential area roads, O6L - for pedestrian crossings, left side traffic, O6P - for pedestrian crossings, right side traffic, O7 - for area lighting, O8 - for town and local roads, O26 - for wet surfaces  
**ULOR / DLOR:** 0% / 100%

**GENERAL DATA** **Lifetime LED (L90):** 100 000 h  
**Available on request:** night dimming profile, twilight sensor, 10kV surge protection, NTC, NEMA connector, ZHAGA connector, iBLOC controller  
**Additional information:** Luminaires are not equipped with a tight connector, photobiological risk group RG0 (applies to selected indexes)  
**Other remarks:** the pole and boom sold separately  
**SDCM:** 5  
**Warranty:** 5 years  
**Application:** avenues, sidewalks, parks, residential, public spaces, Railway stations, facades, promenade, roads, local roads, town roads, residential area roads, parking areas, playgrounds

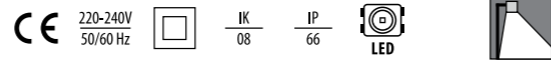

| Electrical number                                      | Code             | Colour   | Type of equipment | (W) | (Lm)  | (lm/W) | (K)  | CRI/Ra | (°C)        |
|--|------------------|----------|-------------------|-----|-------|--------|------|--------|-------------|
| <b>Artera, protection glass II (L550 H100, 9,2 kg)</b> |                  |          |                   |     |       |        |      |        |             |
| 45 155 51  | 130355.3L042.070 | Graphite | DALI              | 49  | 7350  | 150    | 4000 | >70    | -40 ... +50 |
| 45 155 52  | 130355.5L042.070 | Graphite | ON/OFF            | 49  | 7350  | 150    | 4000 | >70    | -40 ... +50 |
| 45 155 53  | 130355.3L082.070 | Graphite | DALI              | 68  | 9750  | 143    | 4000 | >70    | -40 ... +50 |
| 45 155 54  | 130355.5L082.070 | Graphite | ON/OFF            | 68  | 9750  | 143    | 4000 | >70    | -40 ... +50 |
| 45 155 55  | 130355.3L122.070 | Graphite | DALI              | 106 | 13450 | 127    | 4000 | >70    | -40 ... +50 |
| 45 155 56  | 130355.5L122.070 | Graphite | ON/OFF            | 106 | 13450 | 127    | 4000 | >70    | -40 ... +50 |

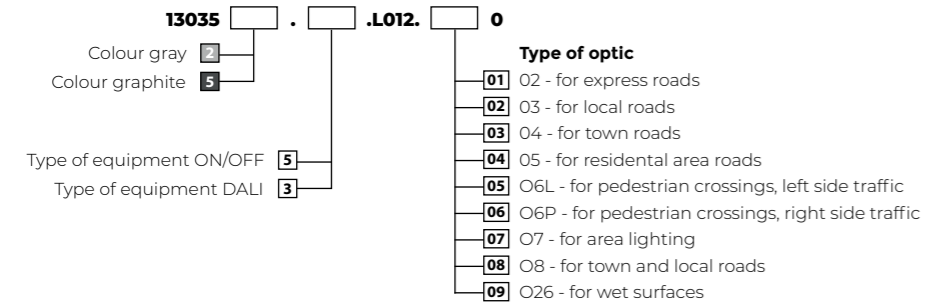

**Also available in following colours**

- Black (RAL 9005)
- White (RAL 9010)
- All RAL colours

**OTHER PICTURES**



**DIMENSIONAL DRAWING**

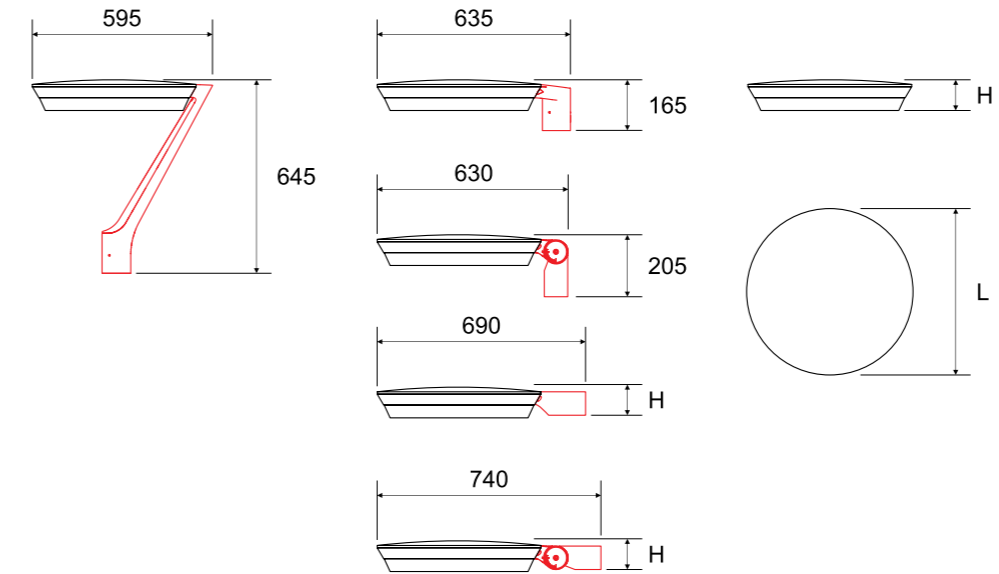

**ACCESSORIES**







IP65 decorative post-top fitting

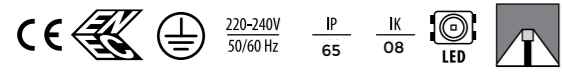

**CONSTRUCTION** **Mounting:** post top with 60mm spigot entry  
**Body:** die cast aluminium  
**Cover:** clear polycarbonate  
**TECHNICAL DATA** **Driver:** included, integral  
**Dimming:** N/A  
**Power factor:** >.95  
**Electrical connection:** pre-wired with 6m H05RN-F flex  
**GENERAL DATA** **Application:** parks, gardens and pathways  
**Operating temperature:** -20°C - +25°C  
**Lumen depreciation:** L90: B10: 100,000 hours  
**SDCM:** <3  
**Warranty:** 5 years



| Electrical number | Code              | W  | lm   | lm/W | K    | CRI/Ra |
|-------------------|-------------------|----|------|------|------|--------|
| <b>Fremont</b>    |                   |    |      |      |      |        |
| 45 440 02         | NFM40/LSOH/6M/840 | 31 | 3302 | 107  | 4000 | ≥80    |

OTHER PICTURES



DIMENSIONAL DRAWING

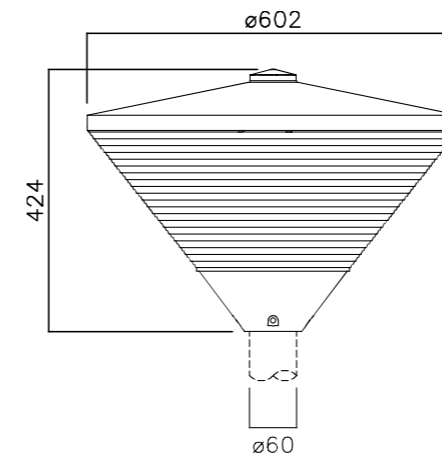

LIGHT BEAM CURVES

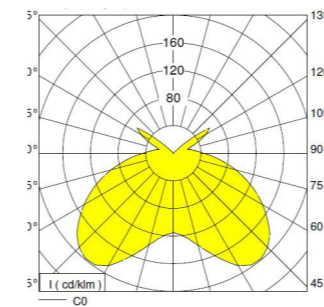

FREMONT

Tube Maxi P is a pole top version of the the largest luminaire in the Tube family, specially treated for outdoor use and is great for lighting up large areas in public environment. The luminaires comes with integrated COB LED module with integrated LED drivers and with different light distributions. Asymmetric light distribution. The Tube Maxi series is not dimmable. This model comes as a complete set for mouting directly to an existing Pole-top of different sizes. Please indicate size when ordering. Class I – IP65. Material: Die-cast aluminium with tempered safety glass.

- TECHNICAL DATA** **Mounting:** ground  
**Body:** high pressure die-cast aluminium  
**Colour:** graphite
- ELECTRICAL DATA** **Includes light source:** YES  
**Power:** 230V 50-60Hz  
**Type of equipment:** ON/OFF
- OPTICAL DATA** **Light distribution:** asymmetric (also available in symmetric)  
**Way of lighting:** direct
- GENERAL DATA** **Lifetime (L70B10):** 50 000 h  
**SDCM:** 3  
**Warranty:** 5 years



| Electrical number           | Code                 | (IP) | (W)  | (Lm)   | Beam angle | (K)  | CRI | Width/length (mm) |
|-----------------------------|----------------------|------|------|--------|------------|------|-----|-------------------|
| <b>TUBE MAXI pole light</b> |                      |      |      |        |            |      |     |                   |
| 45 175 07                   | 7238-9-3-902-02 60MM | 65   | 36   | 3850   | asym       | 3000 | 80  | 367/3500          |
| 45 175 08                   | 7239-9-3-902-02 60MM | 65   | 2x36 | 2x3850 | asym       | 3000 | 80  | 629/3500          |
| 45 174 38                   | 7238-9-3-905-02 60MM | 65   | 36   | 3950   | asym       | 4000 | 80  | 367/3500          |
| 45 154 94                   | 7239-9-3-905-02 60MM | 65   | 2x36 | 2x3950 | asym       | 4000 | 80  | 629/3500          |

**Also available in following colours**

- Black (RAL 9005)
- Graphite (RAL 7016)
- Dark Grey (RAL 7037)
- Aluminium Silver (RAL 9006)
- White (RAL 9010)

**DIMENSIONAL DRAWING**

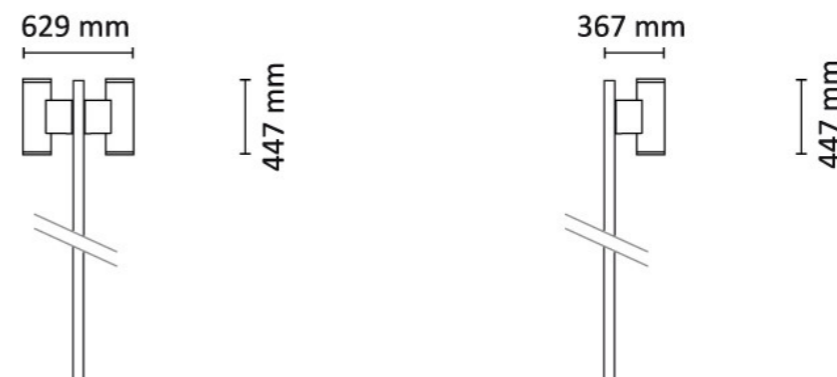

**LIGHT BEAM CURVES**

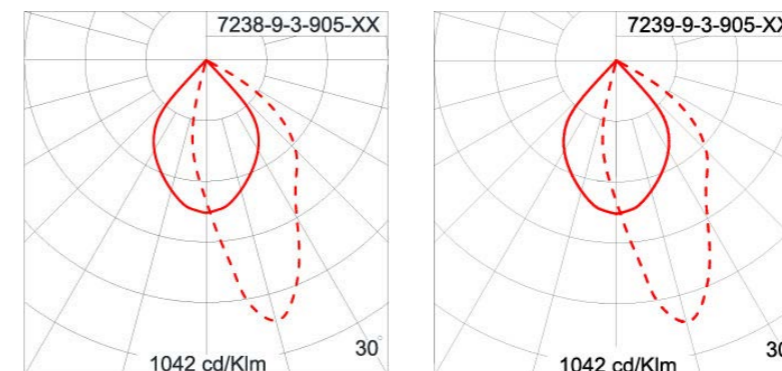



**CHARISMA MEDIUM**  
(page 284)

Park luminaire in modern form with LED light sources.

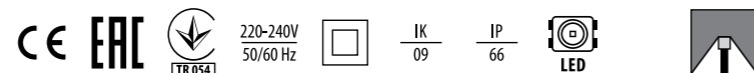

**TECHNICAL DATA**

**Mounting:** on the substrate  
**Body:** high pressure die-cast aluminum  
**Lateral Surface Wind Exposed:** 0,0531 m<sup>2</sup>; 0,1039 m<sup>2</sup>  
**Colour:** graphite, gray  
**Diffuser:** polycarbonate

**ELECTRICAL DATA**

**Power supply efficiency:** >85%  
**Power:** 220-240V 50/60Hz  
**Includes light source:** yes  
**Type of equipment:** ON/OFF, DALI

**OPTICAL DATA**

**Electrical connection:** max 2x2x1,5 mm<sup>2</sup> wire, loopable  
**Light distribution:** omnidirectional  
**Way of lighting:** direct  
**ULOR / DLOR:** 10/90

**GENERAL DATA**

**Warranty:** 5 years  
**SDCM:** 5  
**Application:** avenues, parks, residential, public spaces, playgrounds, promenade, sidewalks



| Electrical number                                      | Code            | Colour   | Type of equipment | (W)  | (Lm) | (lm/W) | (K)  | CRI/Ra | (°C)        | LED lifetime (H) |
|--|-----------------|----------|-------------------|------|------|--------|------|--------|-------------|------------------|
| <b>Height 1000, through wired (W150 H1000, 9,7 kg)</b> |                 |          |                   |      |      |        |      |        |             |                  |
| 45 397 62  | 160015.5L012.21 | Graphite | ON/OFF            | 7,5  | 630  | 84     | 3000 | >70    | -40 ... +50 | (L80B10) 96 000  |
| 45 397 63  | 160015.5L012.21 | Graphite | ON/OFF            | 10   | 865  | 86     | 3000 | >70    | -40 ... +50 | (L80B10) 96 000  |
| 45 397 64  | 160015.5L022.21 | Graphite | ON/OFF            | 13,5 | 1200 | 89     | 3000 | >70    | -40 ... +50 | (L80B10) 96 000  |
| 45 397 65  | 160015.5L022.21 | Graphite | ON/OFF            | 7,5  | 660  | 88     | 4000 | >70    | -40 ... +50 | (L80B10) 96 000  |
| 45 397 66  | 160015.5L032.21 | Graphite | ON/OFF            | 10   | 910  | 91     | 4000 | >70    | -40 ... +50 | (L80B10) 96 000  |
| 45 397 67  | 160015.5L032.21 | Graphite | ON/OFF            | 13,5 | 1260 | 93     | 4000 | >70    | -40 ... +50 | (L80B10) 96 000  |

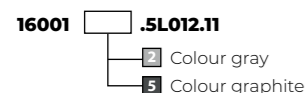

**Also available in following colours**

- Black (RAL 9005)
- White (RAL 9010)
- All RAL colours

**OTHER PICTURES**



**DIMENSIONAL DRAWING**

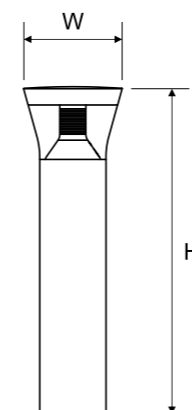

**ACCESSORIES**



e-number 45 397 73  
150240.01092



150240.01109

**LIGHT BEAM CURVES**

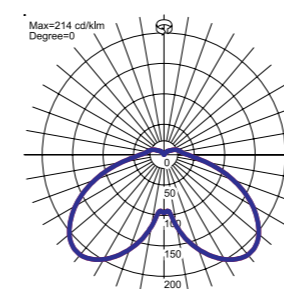

The Se7en bollard are an exciting garden bollard for lighting pathways, flower beds etc. The manufacture is in extruded aluminium in with a modern and innovative design, for ground mounting. Tempered safety glass.

The Se7 comes complete with integrated LED and built-in LED driver, stainless steel anchor bolts, IP68 junction box and pre-connected cable. Specially treated with Unilamp's advanced ASC surface treatment for aggressive environments. That is, a 16 step process topped with special varnish.

|                        |   |
|------------------------|---|
| <b>TECHNICAL DATA</b>  | <b>Mounting:</b> ground<br><b>Body:</b> polycarbonate<br><b>Colour:</b> grey                        |
| <b>ELECTRICAL DATA</b> | <b>Includes light source:</b> YES<br><b>Power:</b> 230V 50-60Hz<br><b>Type of equipment:</b> ON/OFF |
| <b>OPTICAL DATA</b>    | <b>Light distribution:</b> symmetric, asymmetric<br><b>Way of lighting:</b> direct                  |
| <b>GENERAL DATA</b>    | <b>Lifetime (L70B10):</b> 50 000 h<br><b>SDCM:</b> 3<br><b>Warranty:</b> 5 years                    |



| Electrical number | Code            | (IP) | (W) | (Lm) | (lm/W) | (K)  | CRI | Width/height/depth (mm) |
|-------------------|-----------------|------|-----|------|--------|------|-----|-------------------------|
| <b>Se7en</b>      |                 |      |     |      |        |      |     |                         |
| 45 154 61         | 3105830         | 66   | 5,2 | 570  | 110    | 3000 | 80  | 80/790/290              |
| 45 174 28         | 7170-9-3-922-03 | 66   | 5,2 | 570  | 110    | 4000 | 80  | 80/790/290              |

**Also available in following colours**

- Black (RAL 9005)
- Graphite (RAL 7016)
- Dark Grey (RAL 7037)
- Aluminium Silver (RAL 9006)
- White (RAL 9010)

**OTHER PICTURES**

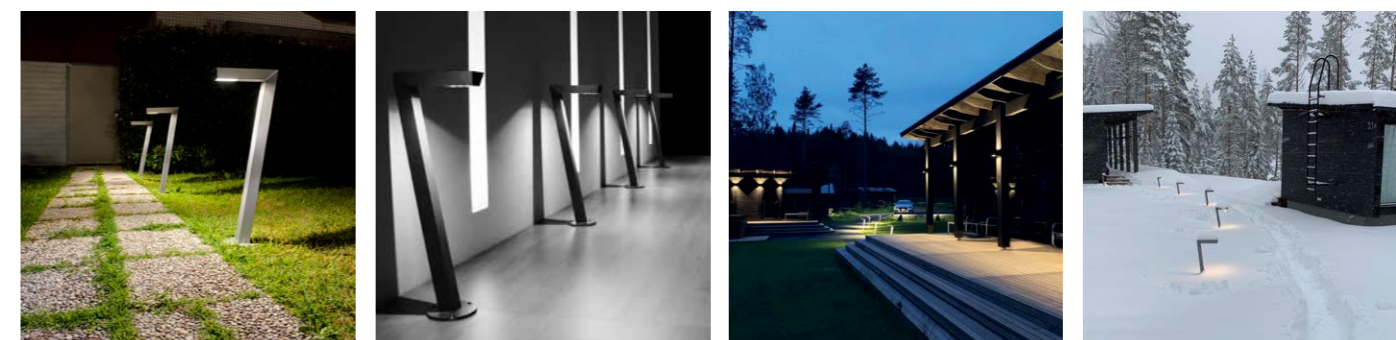

**DIMENSIONAL DRAWING**

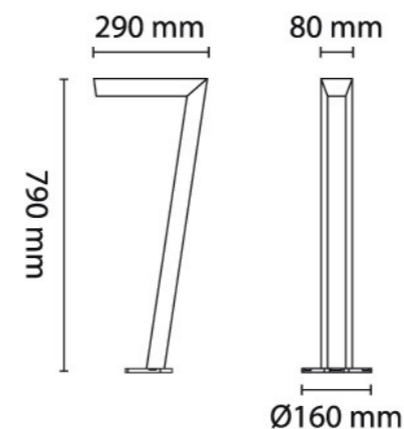

**LIGHT BEAM CURVES**

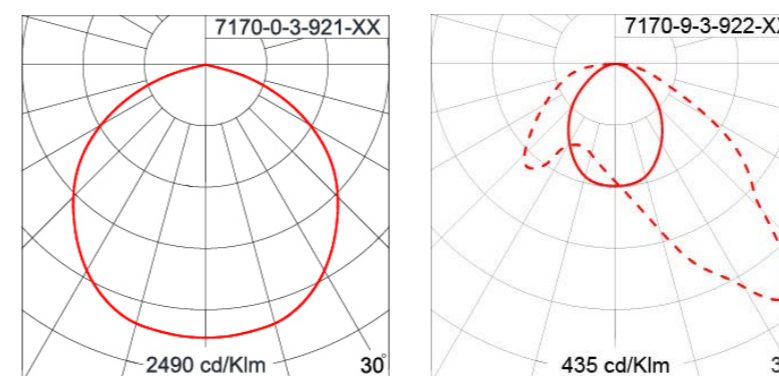

CHARISMA - a range of bollards for residential, community and commercial sites. It is pre wired inside with a class II construction, therefore safe and simple to install. CHARISMA is designed to utilize a very wide light beam, with no lightspill over the horizontal plan. The aim of the luminaire is to make installations with a very long spacing between the bollards. Charisma is available in two color temperatures, 3000K and to 4000K. It is supplied with built-in non dimmable driver. The clear polycarbonate cover with internal glare suppression louvers improves lighting quality by limiting the upward light emission. The product is surface mounted or on casted concrete (anchor bolts are supplied).

- TECHNICAL DATA** **Mounting:** on the substrate
- Body:** aluminium
- Colour:** graphite
- ELECTRICAL DATA** **Includes light source:** YES
- Power:** 230V 50-60Hz
- Type of equipment:** ON/OFF
- OPTICAL DATA** **Light distribution:** symmetric
- Way of lighting:** direct
- GENERAL DATA** **Lifetime (L70B50):** 50 000 h
- SDCM:** 3
- Warranty:** 5 years



| Electrical number | Code    | (IP) | (IK) | (W) | (Lm) | (lm/W) | (K)  | CRI/Ra | Width/height/Depth (mm) |
|-------------------|---------|------|------|-----|------|--------|------|--------|-------------------------|
| <b>Case</b>       |         |      |      |     |      |        |      |        |                         |
| 45 174 25         | 3105825 | 65   | 9    | 14  | 1030 | 74     | 3000 | 80     | 140/900                 |
| 45 174 26         | 3105826 | 65   | 9    | 14  | 1060 | 76     | 4000 | 80     | 140/900                 |

- Also available in following colours**
- Black (RAL 9005)
  - Graphite (RAL 7016)
  - Dark Grey (RAL 7037)
  - Aluminium Silver (RAL 9006)
  - White (RAL 9010)

**PROJECTS**



**DIMENSIONAL DRAWING**

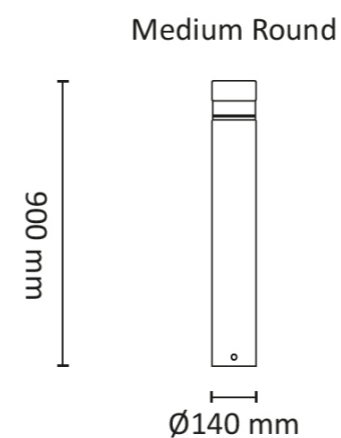

**LIGHT BEAM CURVES**

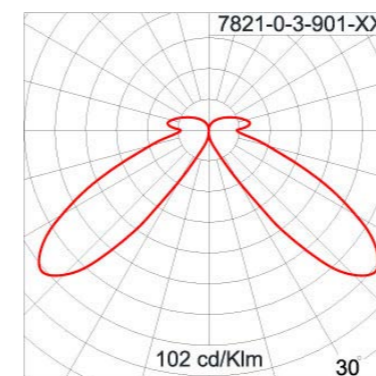

The Macron Flat is a robust circular beam bollard with a powerful housing and excellent glare shield. The luminaire is made of cast/profile aluminium and specially treated with Unilamp's advanced ASC surface treatment for aggressive environments. It is therefore well suited in public environments.

Macron comes with 23W or 38W effect. The luminaire has clear impact-resistant polycarbonate cover and it is supplied with anchor bolts. The luminaire can also be screwed to a solid surface. Alternatively, a foundation adapter can be supplied to 108mm foundations as an accessory.

Also available in 4000K colour temperature.

- TECHNICAL DATA** **Mounting:** ground
- Body:** high pressure die-cast aluminium
- Colour:** graphite
- ELECTRICAL DATA** **Includes light source:** YES
- Power:** 230V 50-60Hz
- Type of equipment:** ON/OFF
- OPTICAL DATA** **Light distribution:** symmetric
- Way of lighting:** direct
- GENERAL DATA** **Lifetime (L70B10):** 50 000 h
- SDCM:** 3
- Warranty:** 5 years

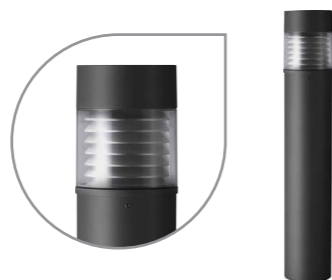

| Electrical number  | Code    | (IP) | (IK) | (W) | (Lm) | (lm/W) | (K)  | CRI | Colour   | Height / diameter (mm) |
|--------------------|---------|------|------|-----|------|--------|------|-----|----------|------------------------|
| <b>Macron Flat</b> |         |      |      |     |      |        |      |     |          |                        |
| 45 154 14          | 3109500 | 65   | 8    | 38  | 1310 | 87     | 3000 | 80  | Graphite | 982/175                |
|                    | 3109502 | 65   | 8    | 23  | 980  | 43     | 3000 | 80  | Graphite | 982/175                |

**Also available in following colours**

- Black (RAL 9005)
- Graphite (RAL 7016)
- Dark Grey (RAL 7037)
- Aluminium Silver (RAL 9006)
- White (RAL 9010)

**OTHER PICTURES**

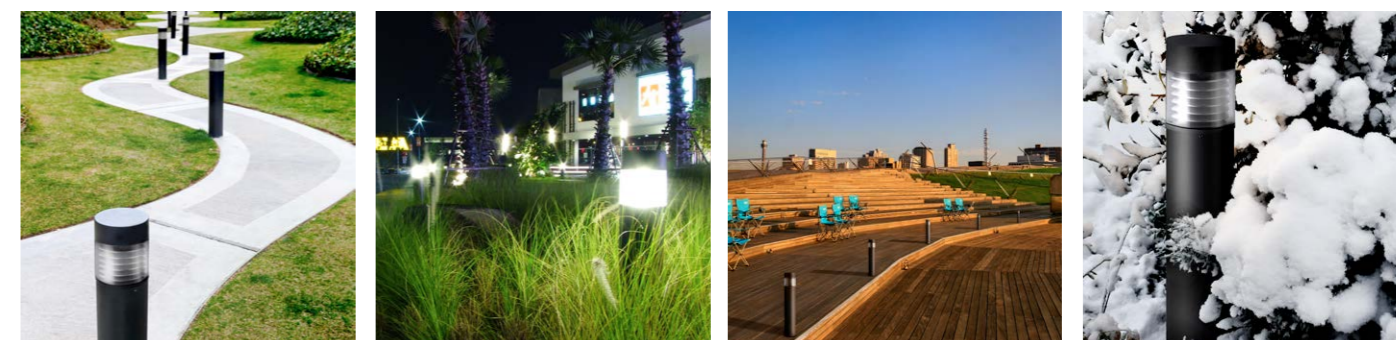

**DIMENSIONAL DRAWING**

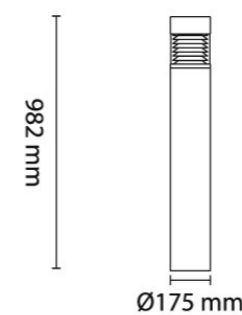

**LIGHT BEAM CURVES**

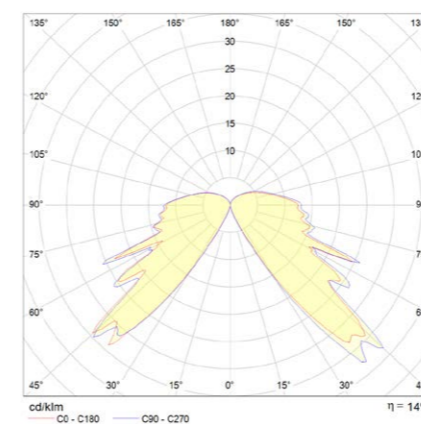



AGAR a range of wall light and bollard with direct or indirect light distribution with COB LED. It is generally installed in the walk ways, parks and open spaces. It provides general lighting for the architectural environment as well as being an eye-catching object. The vandal resistant polycarbonate diffuser lens is available in prismatic or opal option. It spreads the light evenly on walls and surfaces. The product is surface mounted or on casted concrete (anchor bolts are supplied).

- TECHNICAL DATA** **Mounting:** on the substrate
- Body:** high pressure die-cast aluminium
- Colour:** graphite
- Diffuser:** opal, prismatic
- ELECTRICAL DATA** **Includes light source:** YES
- Type of equipment:** ON/OFF
- OPTICAL DATA** **Light distribution:** symmetric
- Way of lighting:** direct (also available with indirect light distribution)
- GENERAL DATA** **Lifetime (L70B50):** 50 000 h
- SDCM:** 3
- Warranty:** 5 years

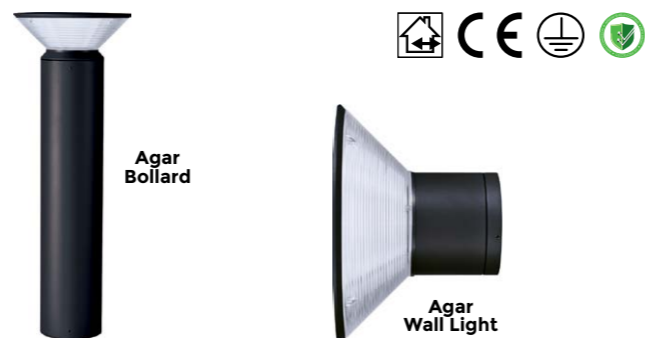

| Electrical number          | Code            | (IP) | (IK) | (W) | (Lm) | (lm/W) | (K)  | CRI/Ra | Diameter/height (mm) |
|----------------------------|-----------------|------|------|-----|------|--------|------|--------|----------------------|
| <b>Wall Light - Opal</b>   |                 |      |      |     |      |        |      |        |                      |
| 45 174 21                  | 7029-0-3-902-02 | 65   | 8    | 16  | 1320 | 73     | 3000 | 80     | 234/219              |
| 45 174 22                  | 7029-0-3-905-02 | 65   | 8    | 16  | 1350 | 75     | 4000 | 80     | 234/219              |
| <b>Bollard - Prismatic</b> |                 |      |      |     |      |        |      |        |                      |
| 45 174 23                  | 7124-0-3-902-02 | 65   | 8    | 36  | 1900 | 48     | 3000 | 80     | 324/895              |
| 45 174 24                  | 7124-0-3-905-02 | 65   | 8    | 36  | 1950 | 49     | 4000 | 80     | 324/895              |

**Also available in following colours**

- Black (RAL 9005)
- Graphite (RAL 7016)
- Dark Grey (RAL 7037)
- Aluminium Silver (RAL 9006)
- White (RAL 9010)

**OTHER PICTURES**

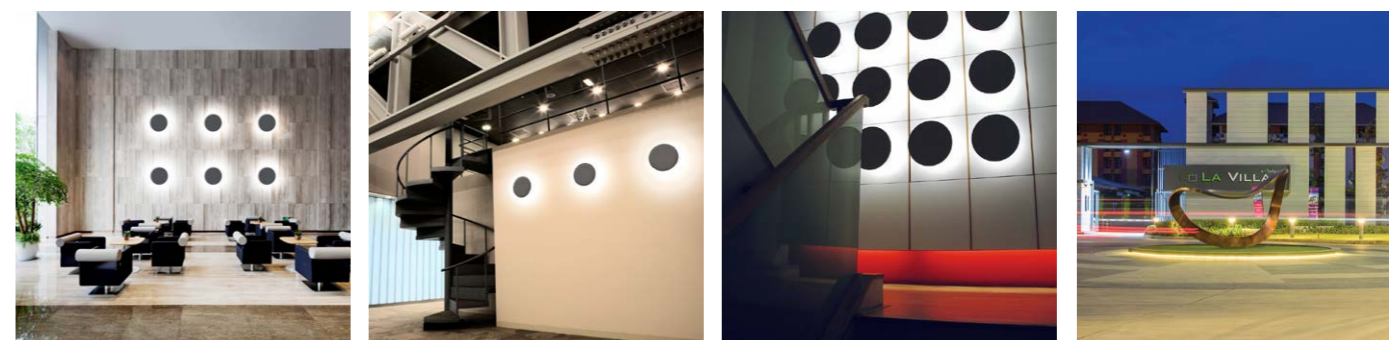

**DIMENSIONAL DRAWING**

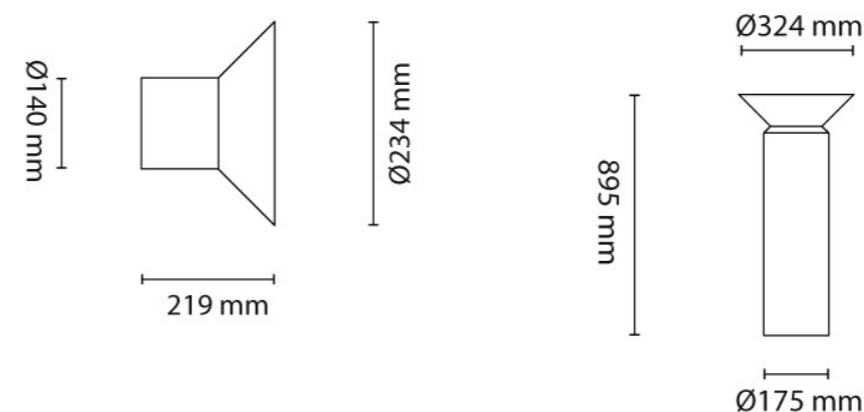

**LIGHT BEAM CURVES**

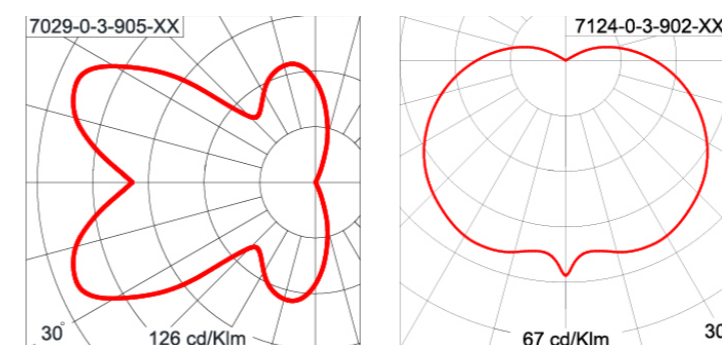



**URBINO**  
(page 294)

Professional streetlight luminaire with LED light sources.



**TECHNICAL DATA**

**Mounting:** on outriggers  $\varnothing 60/48$ mm, on pillar  $\varnothing 60/48$ mm  
**Body:** high pressure die-cast aluminum  
**Lateral Surface Wind Exposed:** 0.033 m<sup>2</sup>  
**Colour:** gray  
**Diffuser:** tempered glass  
**Power supply efficiency:** >90%  
**Power:** 220-240V 50/60Hz  
**Includes light source:** yes  
**Type of equipment:** ON/OFF, DALI

**ELECTRICAL DATA**

**Electrical connection:** luminaire equipped with 3x1.5 mm<sup>2</sup> wire with a length of 50 cm, luminaire equipped with 5x1.5 mm<sup>2</sup> wire with a length of 50 cm, luminaire equipped with 2x1.5 mm<sup>2</sup> wire with a length of 50 cm, luminaire equipped with 4x1.5 mm<sup>2</sup> wire with a length of 50 cm

**OPTICAL DATA**

**Way of lighting:** direct  
**ULOR / DLOR:** 0% / 100%

**GENERAL DATA**

**Available on request:** DIM 1..10V, night dimming profile, twilight sensor, 10kV surge protection, NTC, Zhaga  
**Additional information:** tilt adjustment: -10° to 90° (every 5°)  
**Other remarks:** the pole and boom are not part of the luminaire; luminaire available in protection class I and II  
**SDCM:** 5  
**Warranty:** 5 years  
**Application:** local roads, express roads, town roads, residential area roads, area lighting, avenues, promenade, parking areas



**OTHER PICTURES**



**DIMENSIONAL DRAWING**

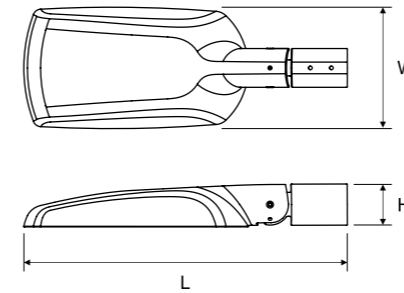

**ACCESSORIES**



| Electrical number | Code | (W) | (Lm) | (lm/W) | (K) | CRI/Ra | (°C) | (h) |
|-------------------|------|-----|------|--------|-----|--------|------|-----|
|-------------------|------|-----|------|--------|-----|--------|------|-----|

**O46, O41, O42, O43, O44L, O44P, O45, O47, O48 optics (L615 W230 H80 mm, 4,1 kg)**

|           |                      |    |       |     |      |     |             |               |
|-----------|----------------------|----|-------|-----|------|-----|-------------|---------------|
| 45 397 57 | 130292.5L091.131.985 | 23 | 3400  | 148 | 4000 | >70 | -40 ... +55 | (L90) 100 000 |
| 45 397 58 | 130292.5L101.131.985 | 35 | 5250  | 150 | 4000 | >70 | -40 ... +50 | (L90) 100 000 |
| 45 397 59 | 130292.5L111.141.985 | 50 | 7750  | 155 | 4000 | >70 | -40 ... +50 | (L90) 100 000 |
| 45 397 60 | 130292.5L121.091.985 | 68 | 10100 | 149 | 4000 | >70 | -40 ... +45 | (L90) 100 000 |

**O27, O28, O29, O30, O32 optics (L615 W230 H80 mm, 4,1 kg)**

|  |                  |    |      |     |      |     |             |               |
|--|------------------|----|------|-----|------|-----|-------------|---------------|
|  | 130292.XL05X.XX1 | 19 | 2250 | 118 | 3000 | >70 | -40 ... +55 | (L75) 100 000 |
|  | 130292.XL06X.XX1 | 36 | 4350 | 121 | 3000 | >70 | -40 ... +50 | (L75) 100 000 |
|  | 130292.XL07X.XX1 | 53 | 6600 | 125 | 3000 | >70 | -40 ... +50 | (L75) 100 000 |
|  | 130292.XL08X.XX1 | 69 | 8600 | 125 | 3000 | >70 | -40 ... +45 | (L75) 100 000 |
|  | 130292.XL01X.XX1 | 19 | 2350 | 124 | 4000 | >70 | -40 ... +55 | (L75) 100 000 |
|  | 130292.XL02X.XX1 | 36 | 4600 | 128 | 4000 | >70 | -40 ... +50 | (L75) 100 000 |
|  | 130292.XL03X.XX1 | 53 | 6950 | 131 | 4000 | >70 | -40 ... +50 | (L75) 100 000 |
|  | 130292.XL04X.XX1 | 69 | 9050 | 131 | 4000 | >70 | -40 ... +45 | (L75) 100 000 |

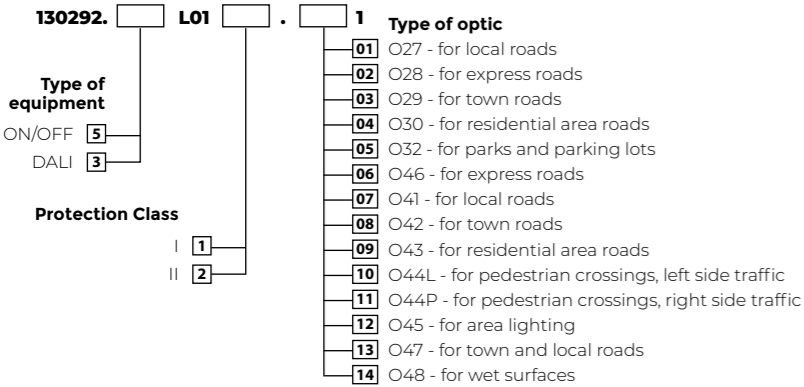

**Also available in following colours**

- Black (RAL 9005)
- Graphite (RAL 7016)
- White (RAL 9010)
- All RAL colours

**LIGHT BEAM CURVES**

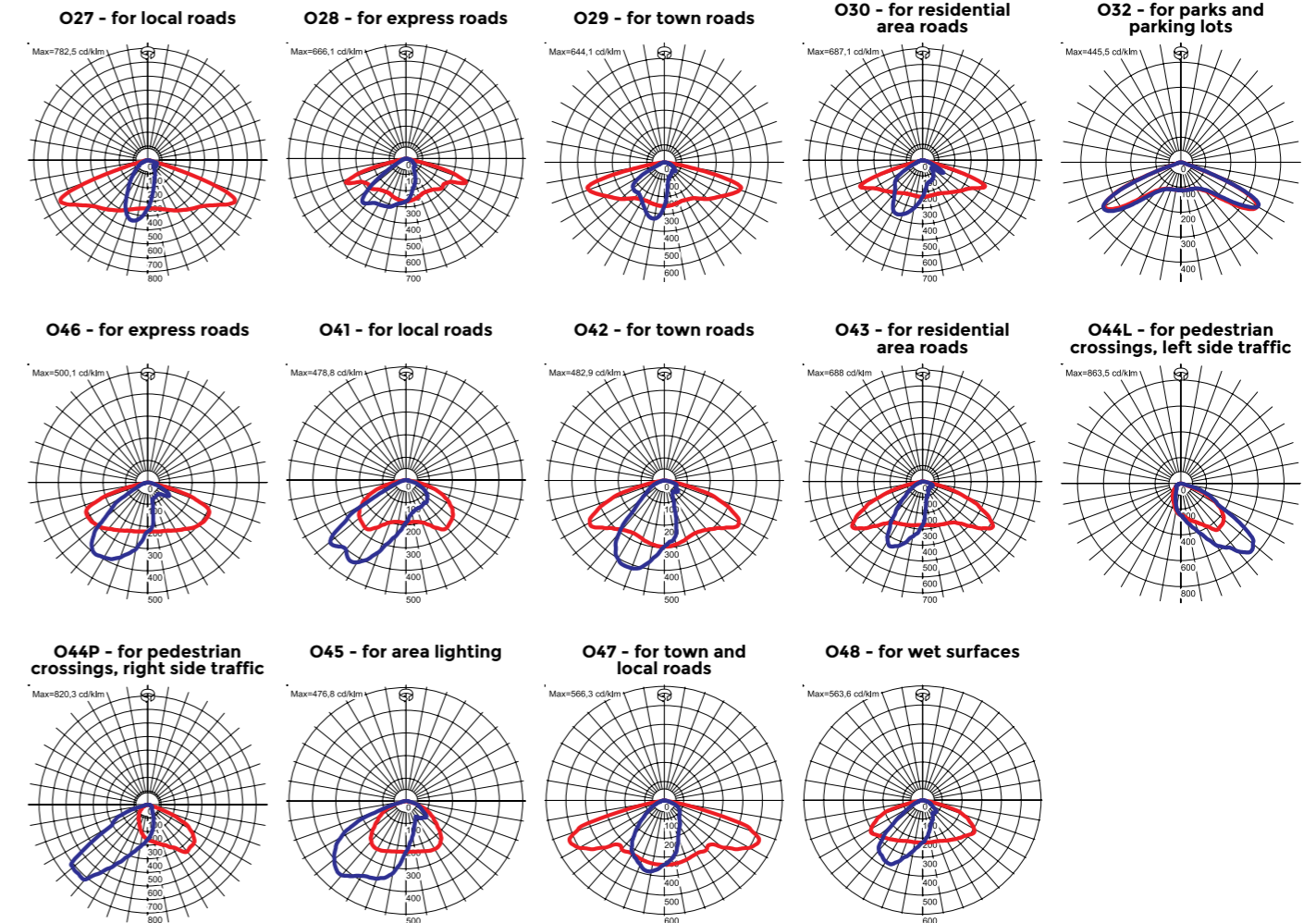

Professional streetlight luminaire for LED light sources.

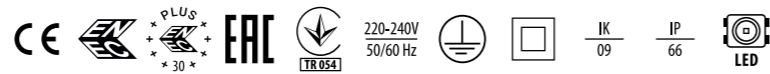

**TECHNICAL DATA**

**Mounting:** on pillar  $\varnothing 60/48$ mm, on pillar  $\varnothing 76$ mm - modification .829, on outriggers  $\varnothing 60/48$ mm, on outriggers  $\varnothing 76$ mm - modification .829

**Body:** high pressure die-cast aluminum  
**Lateral Surface Wind Exposed:** 0.039 m<sup>2</sup>  
**Colour:** gray

**ELECTRICAL DATA**

**Diffuser:** tempered glass  
**Power supply efficiency:** >95%  
**Power:** 220-240V 50/60Hz  
**Includes light source:** yes  
**Type of equipment:** ON/OFF, DALI/ON/OFF

**OPTICAL DATA**

**Electrical connection:** max 3x2,5 mm<sup>2</sup> wire, max 2x2,5 mm<sup>2</sup> wire, max 3x2,5 mm<sup>2</sup> / 5x2,5 mm<sup>2</sup> wire, max 2x2,5 mm<sup>2</sup> / 4x2,5 mm<sup>2</sup> wire

**GENERAL DATA**

**Way of lighting:** direct  
**ULOR / DLOR:** 0% / 100%  
**Lifetime LED (L90):** 100 000 h  
**Available on request:** DALI, DIM 1..10V, night dimming profile, twilight sensor, knife switch, 10kV surge protection, NTC, 1x Zhaga, 2x Zhaga  
**Additional information:** tilt adjustment: -15° to +15° (every 5°), CRI/ Ra >70  
**Additional equipment:** additional anti-corrosive protection (index extension: .985), access to the driver chamber without the use of tools (index extension: .825), luminaire with holder for mounting on a  $\varnothing 76$ mm pillar (index extension: .829)

**Other remarks:** the pole and boom are not part of the luminaire

**SDCM:** 5

**Warranty:** 5 years

**Application:** express roads, local roads, town roads, residential area roads, pedestrian crossings, area lighting, avenues, promenade, cycle paths, public spaces, parking areas



**OTHER PICTURES**



**DIMENSIONAL DRAWING**

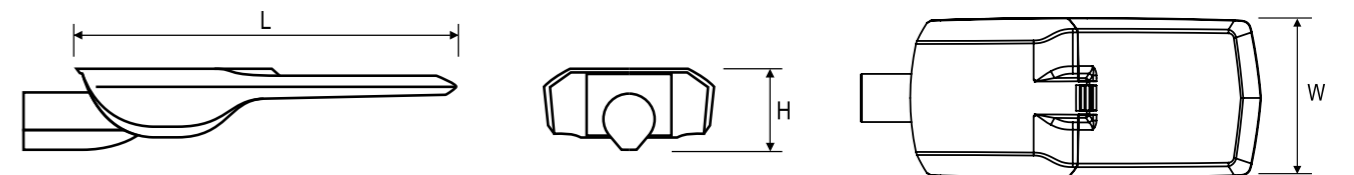

**AVAILABLE MANY DIFFERENT LIGHT BEAM CURVES**

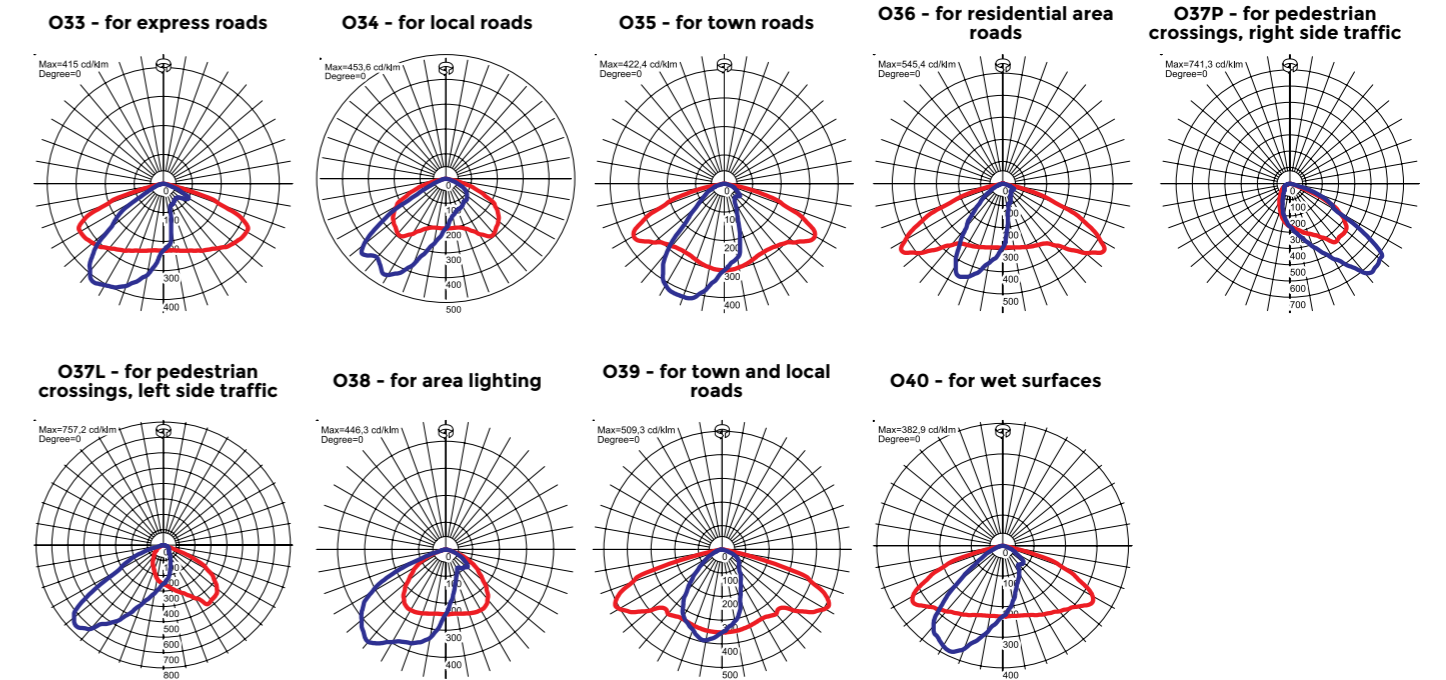

| Electrical number   | Code                 | Type of equipment | (W) | (Lm)  | (lm/W) | (K)  | CRI/Ra | (°C)      |
|---|----------------------|-------------------|-----|-------|--------|------|--------|-----------|
| <b>O33, O34, O35, O36, O37P, O37L, O38, O39, O40 optics (L550 W250 H100 mm, 6,8 kg)</b> |                      |                   |     |       |        |      |        |           |
| 45 397 61   | 130222.5L781.201.985 | ON/OFF            | 102 | 14400 | 141    | 4000 | >70    | * max +50 |
|   | 130222.5L79X.XX1     | ON/OFF            | 23  | 3150  | 137    | 3000 | >70    | * max +50 |
|   | 130222.5L74X.XX1     | ON/OFF            | 23  | 3400  | 148    | 4000 | >70    | * max +50 |
|   | 130222.5L80X.XX1     | ON/OFF            | 35  | 4850  | 139    | 3000 | >70    | * max +50 |
|   | 130222.5L75X.XX1     | ON/OFF            | 35  | 5200  | 149    | 4000 | >70    | * max +50 |
|   | 130222.5L81X.XX1     | ON/OFF            | 51  | 7100  | 139    | 3000 | >70    | * max +50 |
|   | 130222.5L76X.XX1     | ON/OFF            | 51  | 7650  | 150    | 4000 | >70    | * max +50 |
|   | 130222.5L82X.XX1     | ON/OFF            | 68  | 9350  | 138    | 3000 | >70    | * max +50 |
|   | 130222.5L77X.XX1     | ON/OFF            | 68  | 10050 | 148    | 4000 | >70    | * max +50 |
|   | 130222.5L83X.XX1     | ON/OFF            | 102 | 13500 | 132    | 3000 | >70    | * max +50 |
|   | 130222.5L78X.XX1     | ON/OFF            | 102 | 14500 | 142    | 4000 | >70    | * max +50 |

- 130292.** **L01** **1**
- Type of optic**
- 01 O27 - for local roads
  - 02 O28 - for express roads
  - 03 O29 - for town roads
  - 04 O30 - for residential area roads
  - 05 O32 - for parks and parking lots
  - 06 O46 - for express roads
  - 07 O41 - for local roads
  - 08 O42 - for town roads
  - 09 O43 - for residential area roads
  - 10 O44L - for pedestrian crossings, left side traffic
  - 11 O44P - for pedestrian crossings, right side traffic
  - 12 O45 - for area lighting
  - 13 O47 - for town and local roads
  - 14 O48 - for wet surfaces
- Type of equipment**
- ON/OFF 5
  - DALI 3
- Protection Class**
- I 1
  - II 2

- Also available in following colours**
- Black (RAL 9005)
  - Graphite (RAL 7016)
  - White (RAL 9010)
  - All RAL colours

**ACCESSORIES**



Professional streetlight luminaire with LED light sources.

**TECHNICAL DATA**

**Mounting:** on pillar  $\varnothing 60/48$ mm, on pillar  $\varnothing 76$ mm - modification .829, on outriggers  $\varnothing 60/48$ mm, on outriggers  $\varnothing 76$ mm - modification .829

**Body:** high pressure die-cast aluminum  
**Lateral Surface Wind Exposed:** 0.045 m<sup>2</sup>  
**Colour:** gray, graphite

**Diffuser:** tempered glass  
**Power supply efficiency:** 90%

**ELECTRICAL DATA**

**Power:** 220-240V 50/60Hz  
**Includes light source:** yes  
**Type of equipment:** DALI, ON/OFF  
**Electrical connection:** max 5x2,5 mm<sup>2</sup> wire, max 3x2,5 mm<sup>2</sup> wire, max 4x2,5 mm<sup>2</sup> wire, max 2x2,5 mm<sup>2</sup> wire

**OPTICAL DATA**

**Way of lighting:** direct  
**ULOR / DLOR:** 0% / 100%

**GENERAL DATA**

**Lifetime LED (L90):** 100 000 h  
**Available on request:** DIM 1..10V, night dimming profile, twilight sensor, knife switch, 10kV surge protection, NTC, 1x Zhaga, 2x Zhaga  
**Additional information:** tilt adjustment: -15° to +15° (every 5°), CRI/Ra >70  
**Additional equipment:** additional anti-corrosive protection (index extension: .985), luminaire with holder for mounting on a  $\varnothing 76$ mm pillar (index extension: .829)  
**Other remarks:** the pole and boom are not part of the luminaire  
**SDCM:** 5  
**Warranty:** 5 years  
**Application:** express roads, local roads, town roads, residential area roads, pedestrian crossings, area lighting, avenues, promenade, cycle paths, public spaces, parking areas



**OTHER PICTURES**



**DIMENSIONAL DRAWING**

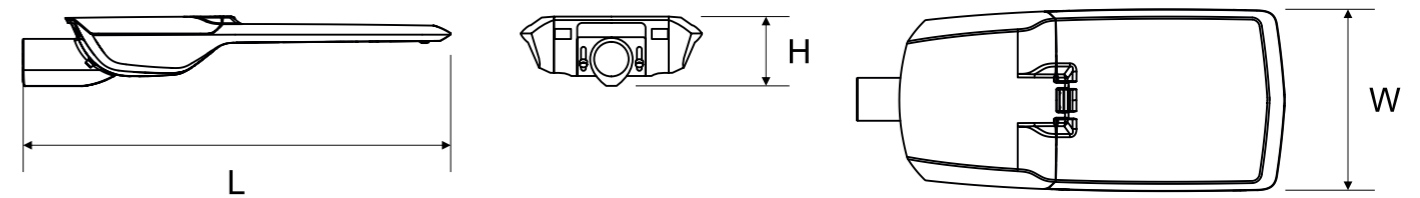

**AVAILABLE MANY DIFFERENT LIGHT BEAM CURVES**

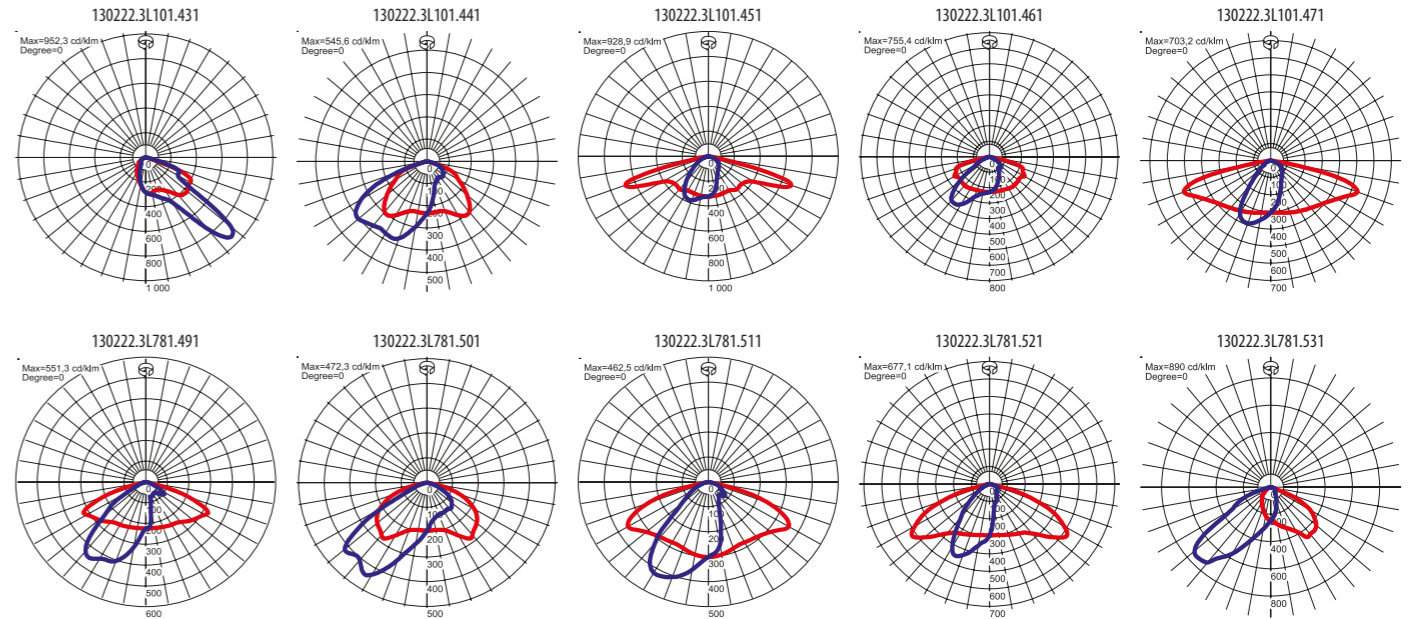

| Electrical number   | Code             | Optic | (W) | (Lm)  | (lm/W) | (K)  | CRI/Ra | (°C)        |
|---|------------------|-------|-----|-------|--------|------|--------|-------------|
| <b>PLUS version (L890 W390 H111 mm, 15,3kg / 17,2 kg)</b> |                  |       |     |       |        |      |        |             |
| 45 155 46   | 130222.5L781.511 | O75   | 101 | 15350 | 152    | 4000 | >70    | -40 ... +50 |
| 45 155 47   | 130222.5L491.511 | O75   | 158 | 21800 | 138    | 4000 | >70    | -40 ... +50 |
| 45 155 48   | 130222.5L631.511 | O75   | 204 | 30050 | 147    | 4000 | >70    | -40 ... +50 |
| 45 155 49   | 130192.3L56.125  | O65   | 253 | 38800 | 153    | 4000 | >70    | -40 ... +50 |
| 45 155 50   | 130192.3L60.125  | O65   | 302 | 44950 | 149    | 4000 | >70    | -40 ... +50 |

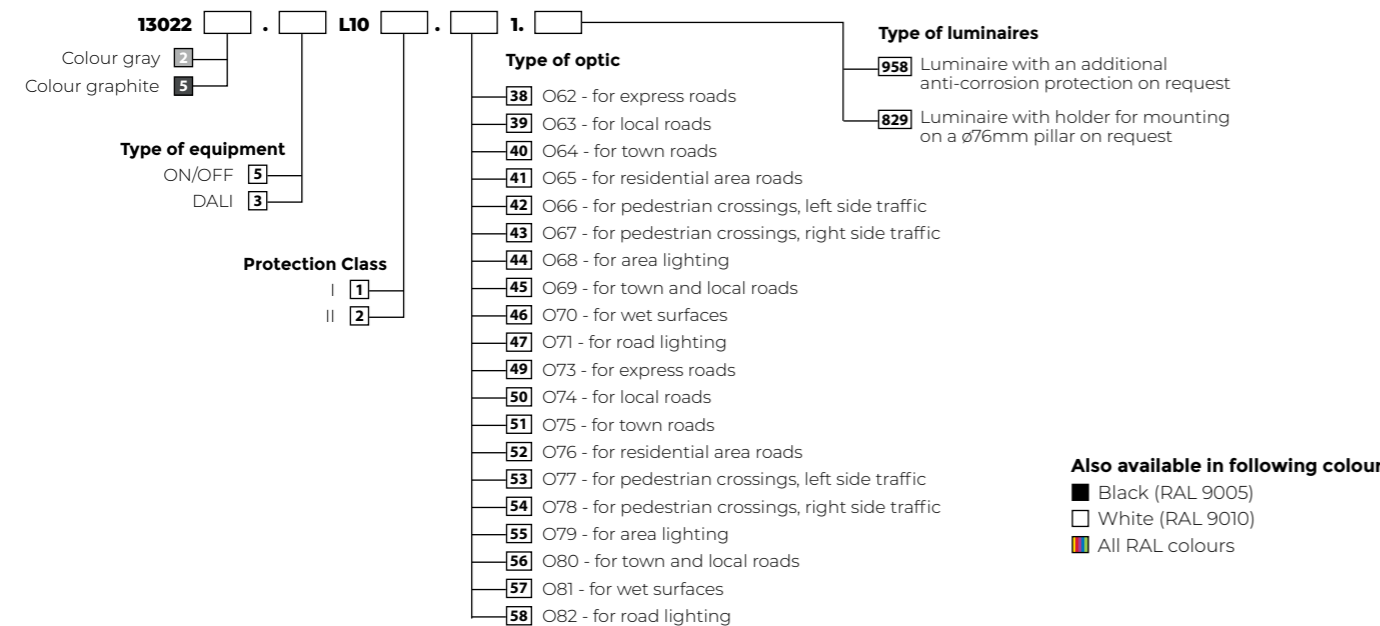



**URBINO**  
(page 294)

# BLACK BOX

energy & life.

[blackbox.rexel.fi](https://blackbox.rexel.fi)



Rexel Finland Oy, Varastokatu 9, (PL 360), 05801 Hyvinkää



@rexelfinland

PUBLICATION 1