

Tuotetiedot

Tuotekoodi	VI06-0144	Sähkönumero	1914224	EAN-koodi	6410019142242
Tuotenimi	Tunneliliitin Cu 2,5-35 mm ² 5x5 (Ristipääruuvi, Pozidriv)			ETIM-luokka	EC000901
Johtimet	Cu 2,5-35 mm ²				

Tekniset tiedot

		-	
		-	
		-	
		-	
		-	
		-	
		-	
Napaluku		1	kpl
Max. Johdinkoko		35	mm ²
Kiristysmomentti			
	2,5-35 mm ²	4	Nm
		-	
		-	
		-	
		-	
Paino		14	g
		-	



Väri / Materiaali	Sinkitty teräs
Kiinnitys / KytKentä	Ruuvikiinnitys 5x5 Cu-kiskoon

Kuvaus

Tunneliliitin soveltuu Cu-johtimien kytkentöihin. Asennetaan kuparikiskoon ruuvikiinnityksellä. Tunneliitin on N- ja PE-kiskojen lisätarvike.

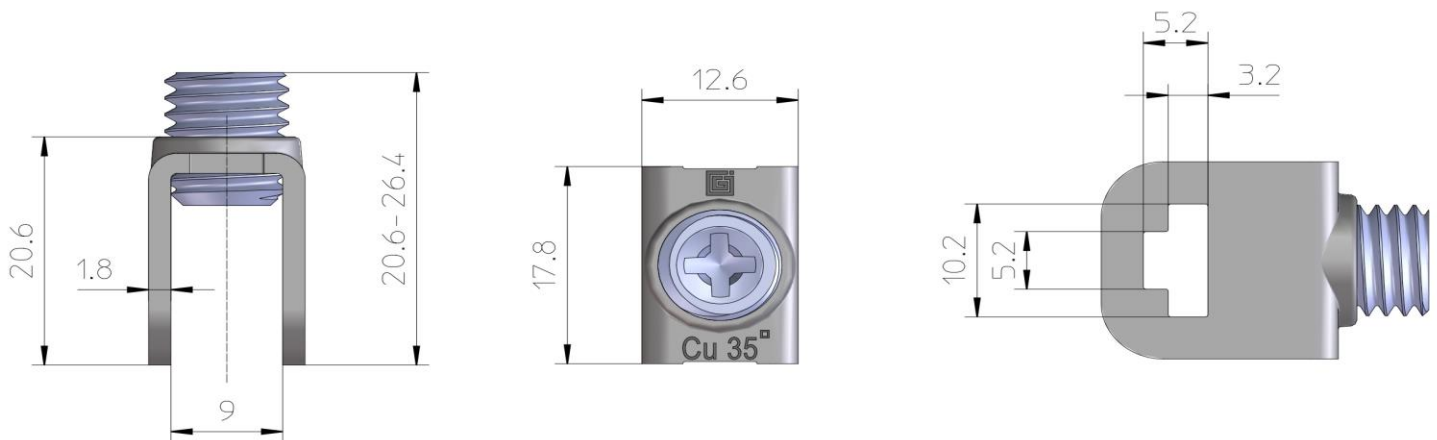
Mittakuva

Pakkaus

Pakkausmuoto	Laatikko	Kpl / Pakkaus	200	Paino [kg]	2,85
Pituus [mm]	176	Leveys [mm]	141	Korkeus [mm]	80

Ouneva Oy

Teollisuustie 21
FI-82730 Tuupovaara
Finland

Tel. +358 400 179 750
info@ouneva.fi

www.ounevagroup.fi
www.ounevaproducts.fi

Product data

Product code	VI06-0144	STK-code	1914224	EAN-code	6410019142242
Product name	Pillar terminal Cu 2,5-35 mm² 5x5 (Cross recess, Pozidriv)			ETIM class	EC000901
Wires	Cu 2,5-35 mm²				

Technical data

	-	
	-	
	-	
	-	
	-	
	-	
	-	
Number of poles	1	pcs
Max. Cross section	35	mm ²
Tightening torque		
	2,5-35 mm ²	4 Nm
	-	
	-	
	-	
	-	
Weight	14	g
	-	



Color / Material	Zinc plated steel				
Mounting / Connection	Screw mounting to 5x5 Cu busbar				

Description

Pillar terminal can be used with copper conductors. It's mounted to copper busbar. Pillar terminal is accessory for N- and PE busbars.

Drawing

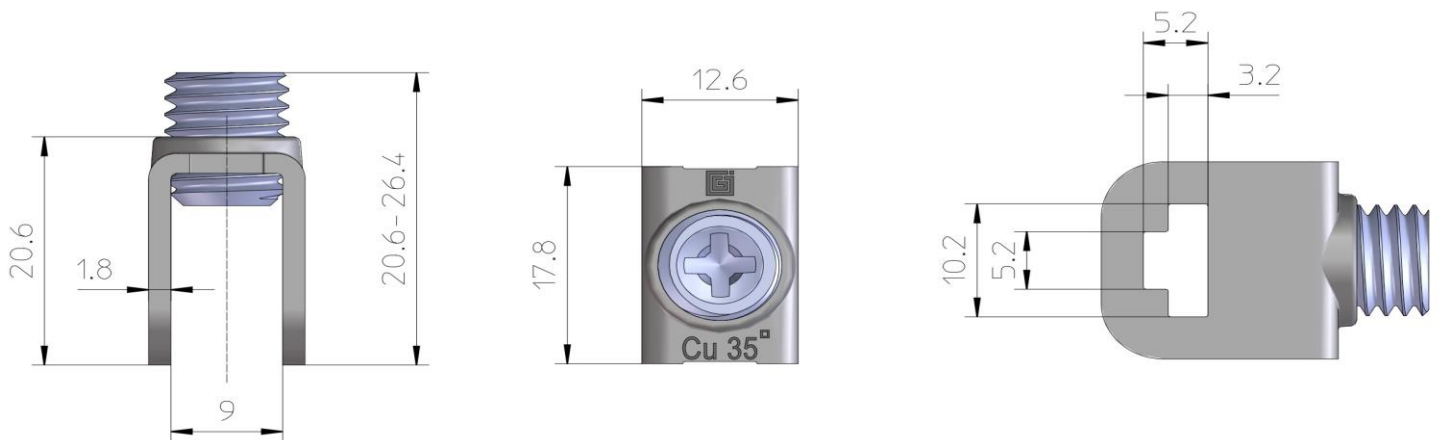

Package

Package	Box	Pcs / Package	200	Weight [kg]	2,85
Length [mm]	176	Width [mm]	141	Height [mm]	80

Ouneva Oy
 Teollisuustie 21
 FI-82730 Tuupovaara
 Finland

Tel. +358 400 179 750
info@ouneva.fi

www.ounevagroup.fi
www.ounevaproducts.fi