

Tuotetiedot

Tuotekoodi	VH01-0014	Sähkönumero	3454104	EAN-koodi	6410034541044
Tuotenimi	Sinkkisalpa PG 13,5 talttaura, SV27				

Tekniset tiedot

Paino	55	g
Avainpää	1	
Sulkuväli GR	27	mm

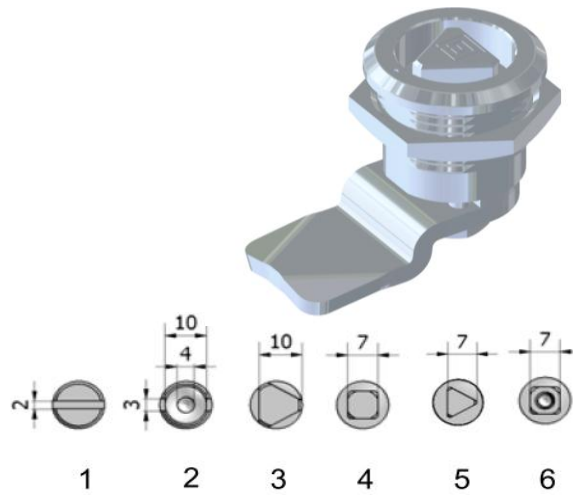

Materiaali/ Pinnointi	Nikkelipinnoitettu sinkki, Sinkitty terästelki
Kiinnitys/ Kytkeä	Vastamutteri

Kuvaus

Kotelosalpa PG 13,5 on saatavilla eri sulkuväleillä ja avainpäillä. Rungon materiaali on nikkelpinnoitettu painevalettu sinkki. Teljen materiaalina on sinkkipinnoitettu teräs. Salpa on tiivistetty O-renkaalla.

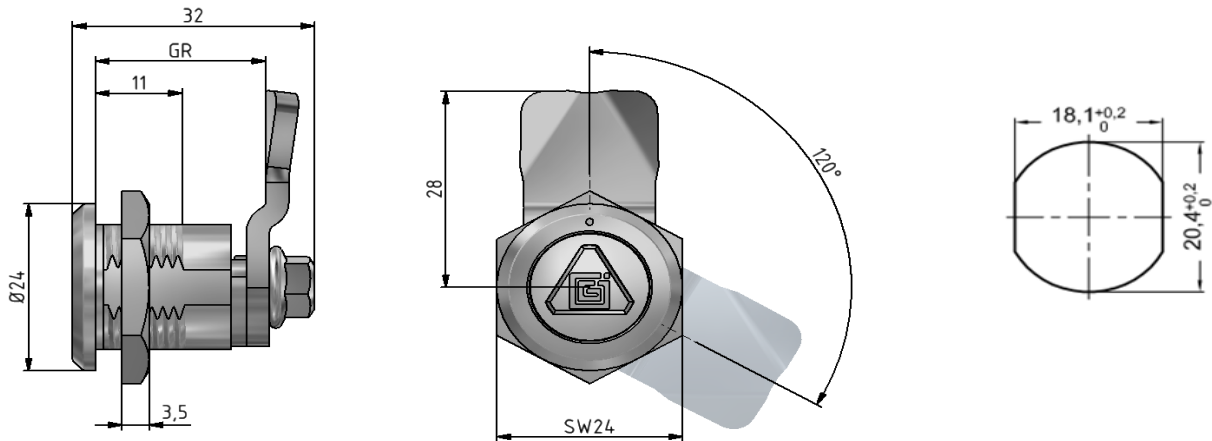
Mittakuva

Pakkaus

Pakkausmuoto	Laatikko	Kpl / Pakkaus	100	Paino [kg]	5,937
Pituus [mm]	210	Leveys [mm]	155	Korkeus [mm]	105

Product data

Product code	VH01-0014	STK-code	3454104	EAN-code	6410034541044
Product name	PG 13.5 TU SV27				

Technical data

Weight	55	g
Key insert	1	
Closing space GR	27	mm

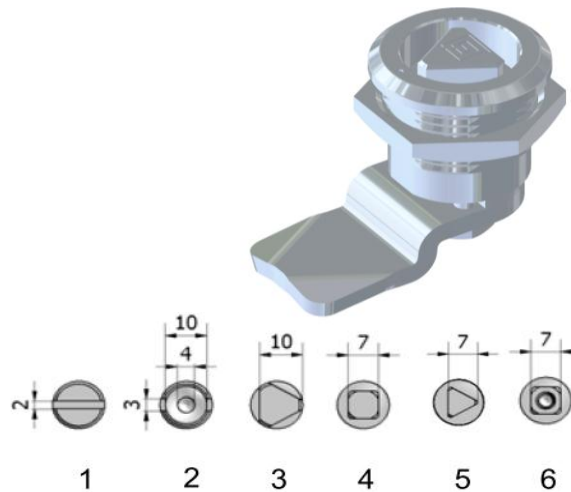

Material/ Coating	Nickel plated zinc, zinc plated steel cam
Mounting/ Connection	Counter nut

Description

Turn cam latch PG 13,5 is available with several key inserts and closing ranges. The body of latch is made of zinc and plated with nickel. Cam is made of zinc coated steel. Sealing is ensured with O-ring.

Drawing

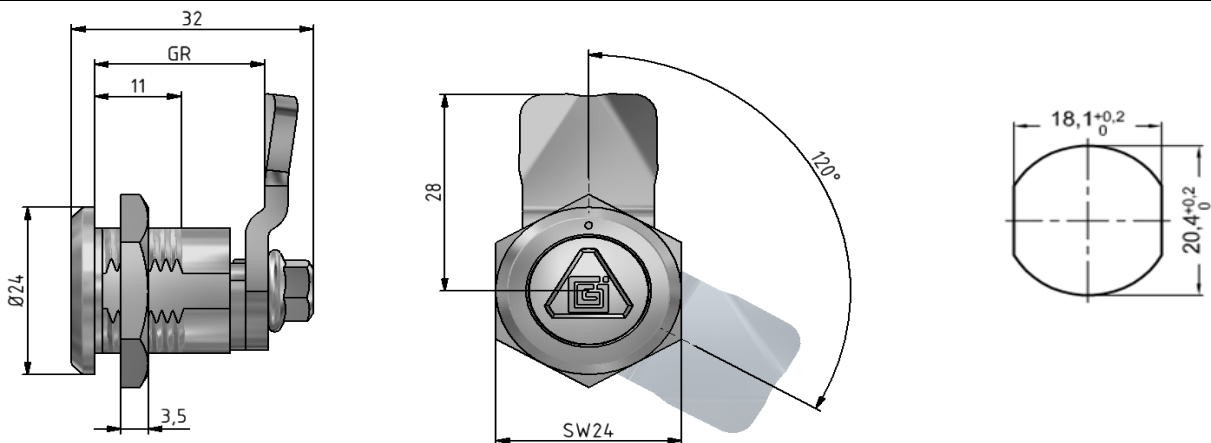

Package

Package	Box	Pcs / Package	100	Weight [kg]	5,937
Length [mm]	210	Width [mm]	155	Height [mm]	105