

vizulo

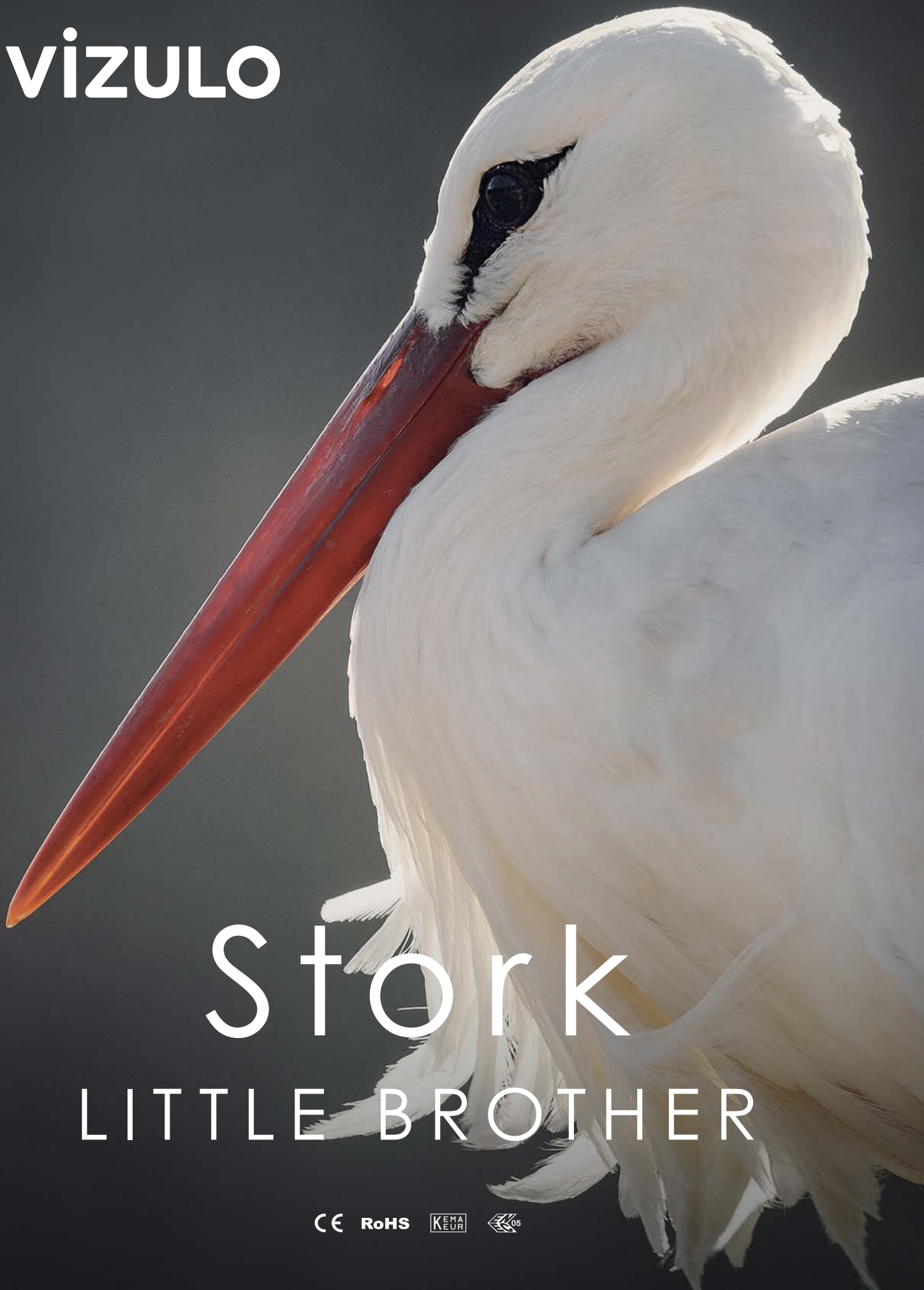

Stork
LITTLE BROTHER



RoHS





Architectural & Landscape

Sports Lighting

Large Outdoor Industrial Area

Agricultural Area

Ventilation cable gland

Combines pressure equalization and cable gland in a single unit. It ensures high air flow rates as well as high water protection capacity

Glass

Flat glass. Glass is fixed to die-cast aluminium frame with metal clips and can easily be replaced

LED module

High quality LED's with optimal thermal resistance and energy consumption characteristic, for high lumen output and long expected life time. Color temperature available: 3000K, 4000K

(5000K, 5700K available on customer request)

Intelligent light control system

Power line or radio frequency

Protection

IP66 for the complete luminaire

Impact resistance

IK10 (Vandal protected)
for the complete luminaire

Module temperature control

The LED driver will start reducing the light output when the LED's approach critical temperature. The temperature is measured via a sensor placed on the PCB

(function available on customer request)

Body

Die-cast aluminium

Lighting protection

Built-in surge protection starting from 3 kV till 10 kV

Light regulation

STORK drivers offer integrated midnight dimming and network-controlled 1-10V and DALI protocols

Opening

Die-cast aluminium clip for tool-less opening or closing, fixed to the frame with stainless steel spring for easy maintenance

Safety switch

Safety switch disconnects power on opening

Traffic roads

Pedestrian Roads

Residential Street/Area

City Centre

Midnight dimming

Midnight dimming provides multi-stage night-time power reduction based on an internal timer referenced to the power on/off time. There is no need for an external control infrastructure. The unit automatically performs a dimming profile based on the predefined scheduled reference to the midpoint, which is calculated based on the power on / off times.

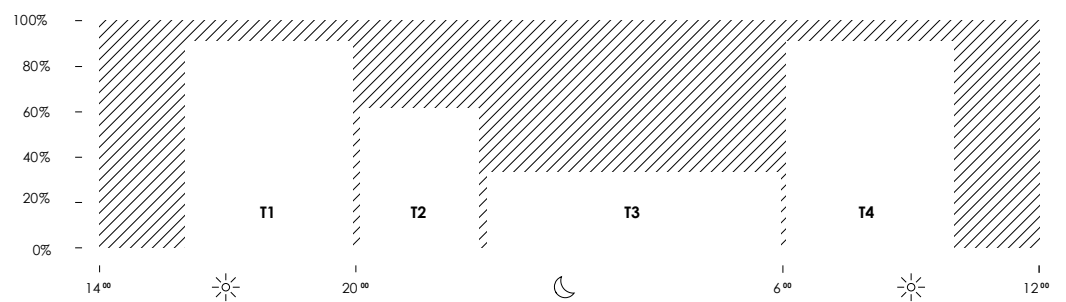

Stork little brother



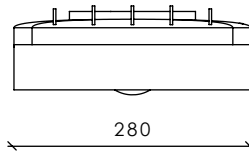
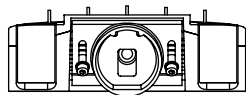
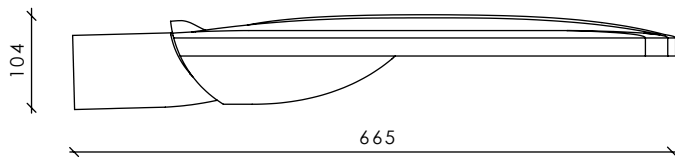

Other colors available on request

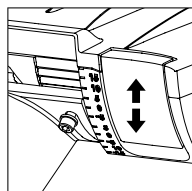
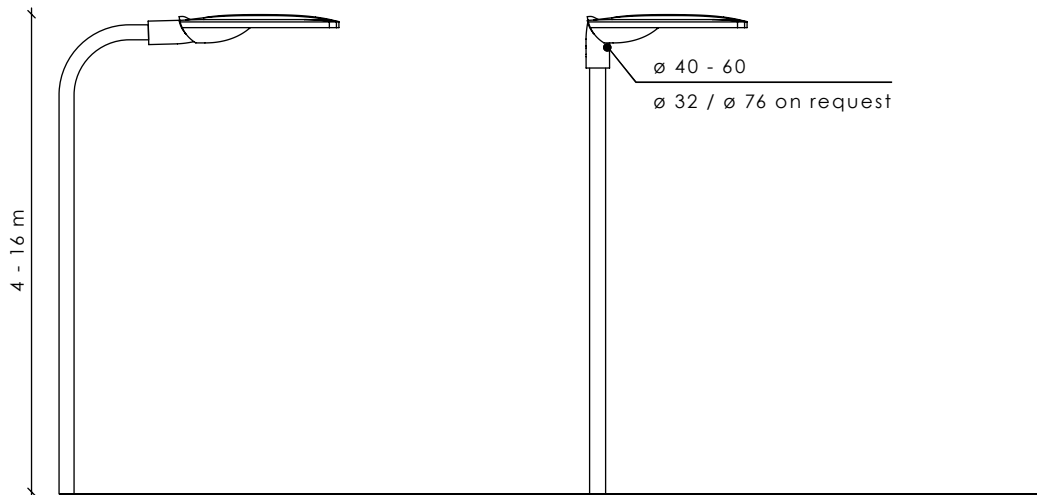

$\leq -5 \dots 20$

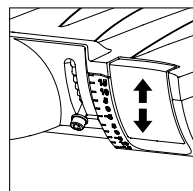

$\leq -20 \dots 5$

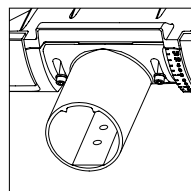

Horizontal entry

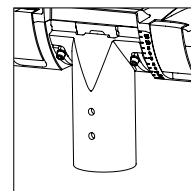

Vertical entry

Technical information



V	220 - 240	1-10V; DALI; Midnight dimming
Hz	50 - 60	Radio frequency / Power line ⁽³⁾
W	18 - 178	3; 6; 10 kV (optional) ⁽⁴⁾
	18 - 200 ⁽⁷⁾	Warranty 5 years
lm	2300 - 23450	100 000h (L80B10C10) ⁽⁵⁾
lm/W	124 - 142	100 000 h (L95B10C10) ⁽⁶⁾
K	3000 / 4000 ⁽¹⁾	
°C	-40 to +50	
CRI	>70 / >80 ⁽²⁾	<i>Body:</i> Die-cast aluminum
		<i>Spigot:</i> ø 40-60, with accessories ø 32; ø 76
		<i>Neto weight:</i> 5,96 - 7,03 kg
		<i>Max.wind load</i>
		<i>area, SCd, m2:</i> 0,04

⁽¹⁾ 5000; 5700 K available on request

⁽²⁾ Luminaries with color rendering index (CRI): Ra >90 on request

⁽³⁾ Optional. Available only with DALI ; 1 - 10 V

⁽⁴⁾ 10 kV (L-N; L/N-PE) surge protection device available on request

⁽⁵⁾ Average lifetime value for ECO model at Ta = 25C is 100 000h L80/B10*

*This value is only informative and may change according to selected article. LED Lifetime is strongly depending from LEDs current and junction temperature – increase in LED current and luminaire power lead to increase of junction temperature and as consequence lifetime decrease. Thus, luminaire models with lower power, lower current (and lower junction temperature) will have higher lifetime than standard models and will reach 100 000h L90/B10. And high power and high current luminaire models may have negative lifetime deviation comparing to standard models. To receive precise value please contact VIZULO export representatives.

⁽⁶⁾ Standard / High Power / High Density at Ta=25°C, this value is only informative and may change according to selected article

⁽⁷⁾ Configuration not in production

⁽⁸⁾ Coming soon

Model name principles

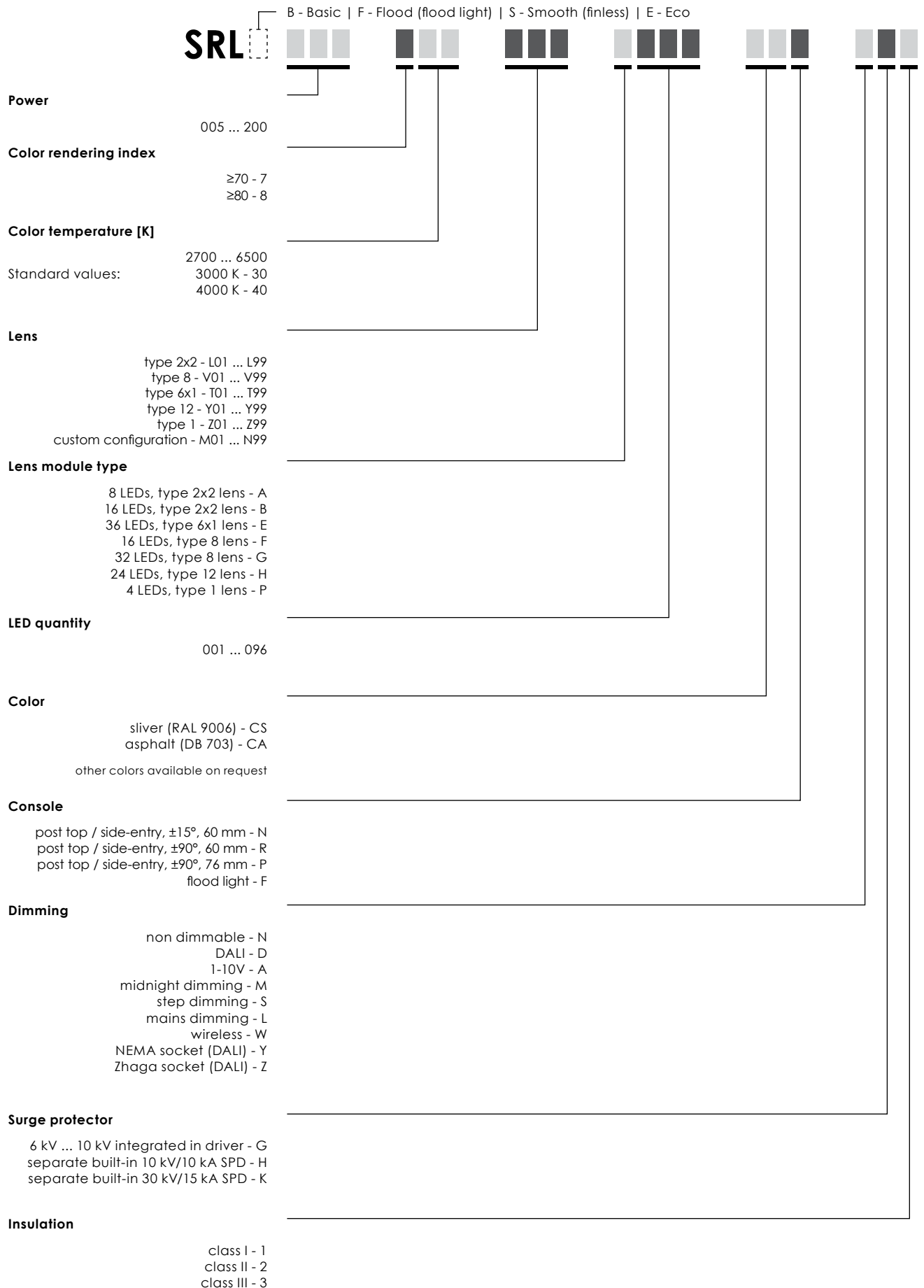

EXAMPLE SRLB 005 730 L01 A001 CSN NG1

Standard modules

4000K

Number of LED's	16			32			48			64		
Nominal current, mA	350	500	700	350	500	700	350	500	700	350	500	700
Power, W	18	27	37	37	48	68	53	76	102	69	97	137
Luminous Flux, lm	2110	3139	4151	4535	5814	7911	6707	9284	11942	8841	11775	16355
Efficacy, lm/W	117	116	112	122	121	116	126	122	118	128	121	119
Power factor, PF	0,91	0,95	0,97	0,95	0,97	0,97	0,96	0,98	0,96	0,94	0,96	0,98

Luminaire efficacy	3000 K	18 - 137 W	2110 - 16355 lm	117 - 119 lm/W
	4000 K	18 - 137 W	2183 - 16919 lm	121 - 123 lm/W
	5000 K	18 - 137 W	2256 - 17483 lm	125 - 128 lm/W

High density modules

Only with optic 01 / 04 / 05 / 10 / 20 / 22 / 35

4000K

Number of LED's	32			64			80		
Nominal current, mA	350	500	700	350	500	700	350	500	750
Power, W	37	48	68	69	97	137	89	123	178
Luminous Flux, lm	4867	6184	8691	9513	12799	17297	12002	16003	22300
Efficacy, lm/W	132	129	128	138	132	126	135	130	125
Power factor, PF	0,95	0,97	0,97	0,94	0,96	0,98	0,95	0,97	0,98

Luminaire efficacy	3000 K	37 - 178 W	4725 - 21580 lm	120 - 128 lm/W
	4000 K	37 - 178 W	4888 - 22300 lm	124 - 132 lm/W
	5000 K	37 - 178 W	5051 - 23000 lm	129 - 137 lm/W

ECO

4000K

	16			32			48		
Number of LED's									
Nominal current, mA	350	500	700	350	500	700	350	500	590
Power, W	37	52	75	71	101	147	102	149	178
Luminous Flux, lm	5200	6850	9000	10400	13650	17900	14980	20210	22500
Efficacy, lm/W	141	132	120	146	135	122	147	135	126
Power factor, PF	0,85	0,9	0,91	0,94	0,97	0,98	0,97	0,98	0,98

Logistic information

Carton size/cm L*W*H	Quantity per carton/pcs	Pallet quantity in 20' sea container	Pallet quantity in 40' sea container	QTY per pallet/pcs	Full pallet size/cm L*W*H	Number of luminaires per row	Number of rows
68,5 x 30 x 16,5	1	11	25	40	120 x 80 x 177	4	10

	NETO WEIGHT/KG		BRUTO WEIGHT/KG	
	Per 1 pcs	Per pallet	Per 1 pcs	Per pallet
STORK Little Brother 1 module luminaires	8,45	338	9,15	366
STORK Little Brother 2 module luminaires	8,55	342	9,25	370
STORK Little Brother 3 module luminaires	8,75	350	9,45	378
STORK Little Brother 4 module luminaires	9,05	362	9,75	390
STORK Little Brother pedestrian crossing luminaires	Depend on module quantity		Depend on module quantity	

Console



Optics

01

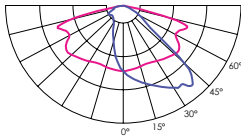

02

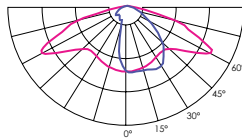

03

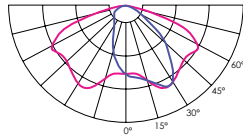

04

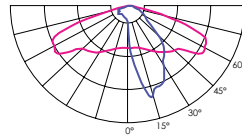

05

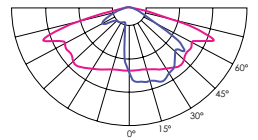

06

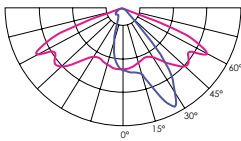

07

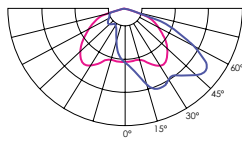

08

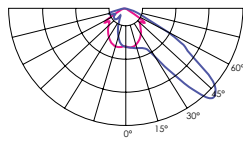

09

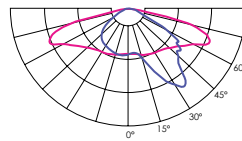

17

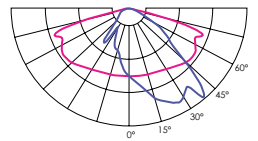

18

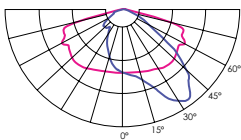

19

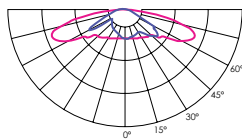

20

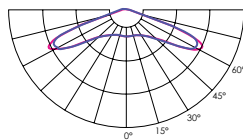

22

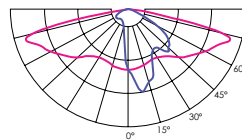

35

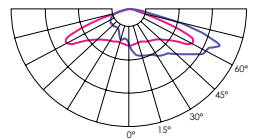

36

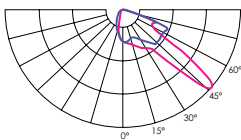

37

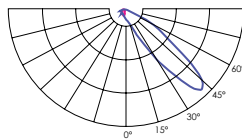

Pedestrian crossing optics

11

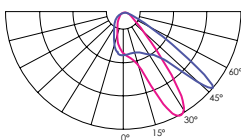

12

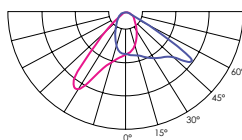



Gothenburg | Sweden





Hafnarfjordur | Iceland

Accessories

Citintelly Segment controller

Art. 70010004

Segment Controller receives commands from Citintelly server via GSM and transmits tasks to Luminaire Controller via radio frequency communication.

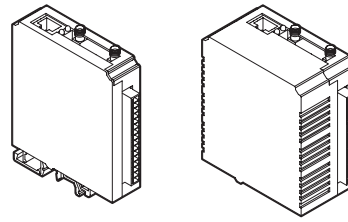

Citintelly Luminaire controller

Luminaire Controller is wireless mesh-networking device that uses 868 MHz for communication with Segment Controller and other Luminaire Controllers. It is delivered in various configurations to meet the needs of your applications.

Art. 70010001 /
LC2M-23-05-R Luminaire
Controller - 2 relays

Art. 70010002 /
LC2M-12-05-R Luminaire
Controller - 1 relay

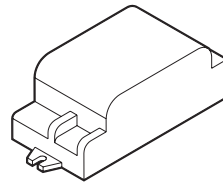

Citintelly Surge Protection device

Art. 70020001

Surge Protection device offers protection against lighting surges;

Voltage Protection level up (L-N) $\leq 1,5$ kV

Voltage Protection level up (L/N-PE) $\leq 2,0$ kV

$U_{oc} = 10$ kV

$I_{max} = 10$ kA

$I_{nom} = 5$ kA

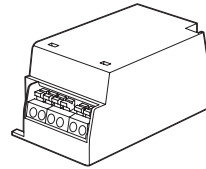

Radio Frequency Antenna

Art. 70000108

Heavy duty IP67 enclosure
Mounted in cabinet or luminaire body
with 14 mm screw
SMA connector



NEMA Socket

2213362-3, 5 pin NEMA socket 105°C wires

Art. 70000362

2213362-4, 7 pin NEMA socket 105°C wires

Art. 70000333

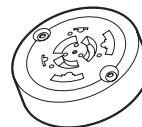

Dummy Link for NEMA Socket

Art. 70000113

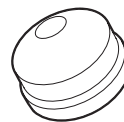

MSLC205RG Luminaire controller + radar, Zhaga, 80mm

Art. 70010027

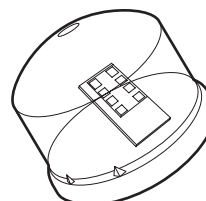

**MSLC205RGL Luminaire controller,
Zhaga, 80mm**

Art. 70010029

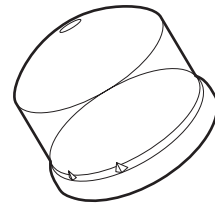

Zhaga socket no cap

Art. 70000612



Zhaga socket with cap

Art. 70000613



Console adapter

40mm to 30mm

Art. 70055002

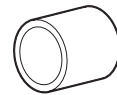

Console adapter

Spigot size 60 - 76mm

Art. 70044002

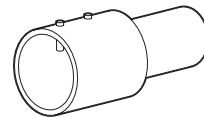

Wall mounting bracket

Spigot size 40 - 60 mm

Art. 70044001

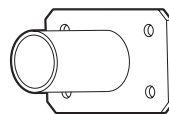

Wall mounting bracket

Vertical

Art. 70044004

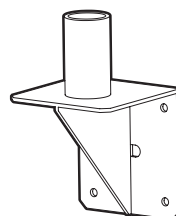

Adjustable Console ±90°

60 mm - Stork/ Stork LB

Art. 70044012

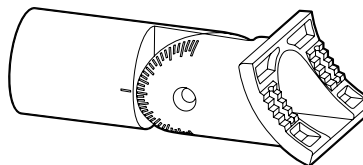

Adjustable Console ±90°

76 mm - Stork/ Stork LB

Art. 70044013

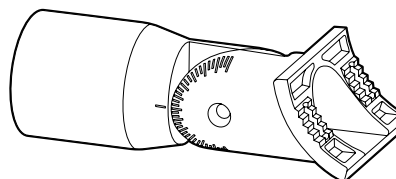

Device connector

Device connectors, standard M25, RST20i5, 5 pole, male, screw connection 250/400V, 20A

Art. 70000315

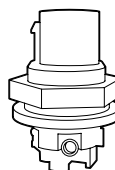

Connector

IP66 rated connector offers easy installation of the street luminaires. 3 wire cable connector

Art. 70000313

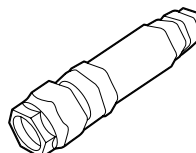

Connector

IP66 rated connector offers easy installation of the street luminaires. 5 wire cable connector

Art. 70000304

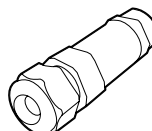

Connection cable

Male - free end, length 1m, RST20i3, 3 pole, 250V, 16A, cable type H05VV, cross section 1,5mm²

Art. 70000363

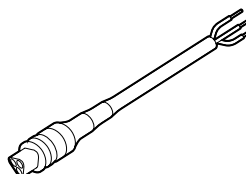

**Pre-installed cable sets
For external power supply**

- 0,5 m long cable.....Art. 70000436
- 5 m long cable.....Art. 70000437
- 6 m long cable.....Art. 70000438
- 8 m long cable.....Art. 70000439
- 10 m long cable.....Art. 70000440
- 12 m long cable.....Art. 70000441
- 18 m long cable.....Art. 70000442
- 20 m long cable.....Art. 70000443
- 22 m long cable.....Art. 70000444
- 25 m long cable.....Art. 70000445

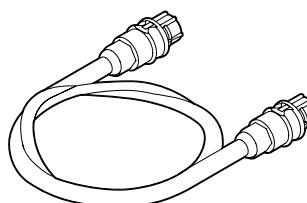

Pre-installed cable sets

For internal power supply:

2 x 1,5mm - 0,5m long cable.....	Art. 70000418
2 x 1,5mm - 5m long cable.....	Art. 70000342
2 x 1,5mm - 6m long cable.....	Art. 70000337
2 x 1,5mm - 8m long cable.....	Art. 70000344
2 x 1,5mm - 10m long cable.....	Art. 70000338
2 x 1,5mm - 12m long cable.....	Art. 70000345
2 x 1,5mm - 18m long cable.....	Art. 70000419

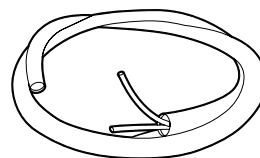

Pre-installed cable sets

For internal power supply:

3 x 1,5 mm - 0,5 m long cable.....	Art. 70000319
3 x 1,5 mm - 5 m long cable.....	Art. 70000320
3 x 1,5 mm - 6 m long cable.....	Art. 70000321
3 x 1,5 mm - 8 m long cable.....	Art. 70000322
3 x 1,5 mm - 10 m long cable.....	Art. 70000323
3 x 1,5 mm - 12 m long cable.....	Art. 70000324
3 x 1,5 mm - 18 m long cable.....	Art. 70000325
3 x 1,5 mm - 20 m long cable.....	Art. 70000425
3 x 1,5 mm - 22 m long cable.....	Art. 70000426
3 x 1,5 mm - 25 m long cable.....	Art. 70000427
3 x 1,5 mm - 32 m long cable.....	Art. 70000430
3 x 1,5 mm - 42 m long cable.....	Art. 70000431
3 x 1,5 mm - 50 m long cable.....	Art. 70000432

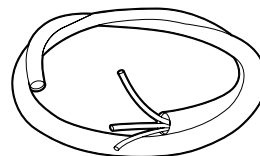

Pre-installed cable sets

For internal power supply:

5 x 1,5 mm - 0,5 m long cable.....	Art. 70000305
5 x 1,5 mm - 5 m long cable.....	Art. 70000316
5 x 1,5 mm - 6 m long cable.....	Art. 70000317
5 x 1,5 mm - 8 m long cable.....	Art. 70000318
5 x 1,5 mm - 10 m long cable.....	Art. 70000306
5 x 1,5 mm - 12 m long cable.....	Art. 70000307
5 x 1,5 mm - 18 m long cable.....	Art. 70000308
5 x 1,5 mm - 20 m long cable.....	Art. 70000428
5 x 1,5 mm - 22 m long cable.....	Art. 70000429
5 x 1,5 mm - 25 m long cable.....	Art. 70000429
5 x 1,5 mm - 32 m long cable.....	Art. 70000433
5 x 1,5 mm - 42 m long cable.....	Art. 70000434
5 x 1,5 mm - 50 m long cable.....	Art. 70000435

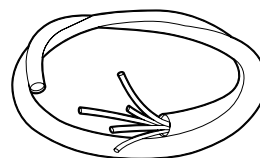

VIZULO

Starta street 1
Riga, LV – 1026, Latvia

Sales: + 371 67 383 023
Production: + 371 67 383 024

office@vizulo.com
www.vizulo.com

